



SCV
WATER

WATER RESOURCES AND WATERSHED COMMITTEE MEETING

Wednesday, September 14, 2022
Meeting Begins at 5:30 PM

Members of the public may attend by the following options:

In Person

Santa Clarita Valley Water Agency
Engineering Services Section
Boardroom
26521 Summit Circle
Santa Clarita, CA 91350

By Phone

Toll Free:
1-(833)-568-8864
Webinar ID: 161 437 8560

Virtually

Please join the meeting from your
computer, tablet or smartphone:

<https://scvwa.zoomgov.com/j/1614378560>

Have a Public Comment?

Members of the public unable to attend this meeting may submit comments either in writing to ekang@scvwa.org or by mail to Eunie Kang, Executive Assistant, Santa Clarita Valley Water Agency, 26501 Summit Circle, Santa Clarita, CA 91350. All written comments received before 4:00 PM the day of the meeting will be distributed to the Committee members and posted on the Santa Clarita Valley Water Agency website prior to the start of the meeting. Anything received after 4:00 PM the day of the meeting will be made available at the meeting, if practicable, and will be posted on the SCV Water website the following day. All correspondence with comments, including letters or emails, will be posted in their entirety.

(Public comments take place during Item 2 of the Agenda and before each Item is considered. Please see the Agenda for details.)

This meeting will be recorded and the audio recording for all Committee meetings will be posted to yourscvwater.com within 3 business days from the date of the Committee meeting.

Disclaimer: Attendees should be aware that while the Agency is following all applicable requirements and guidelines regarding COVID-19, the Agency cannot ensure the health of anyone attending a Board meeting. Attendees should therefore use their own judgment with respect to protecting themselves from exposure to COVID-19.

Santa Clarita Valley Water Agency
Rio Vista Water Treatment Plant
27234 Bouquet Canyon Road
Santa Clarita, CA 91350
(661) 297-1600

[This page intentionally left blank.]



Date: September 7, 2022

To: **Water Resources and Watershed Committee**
Jeff Ford, Chair
Kathye Armitage
Ed Colley
Bill Cooper
Maria Gutzeit

From: Steve Cole, Assistant General Manager

The **Water Resources and Watershed Committee** is scheduled to meet on **Wednesday, September 14, 2022 at 5:30 PM at 26521 Summit Circle, Santa Clarita, CA 91350 in the Engineering Services Section (ESS) Boardroom.** Members of the public may attend in person or virtually. To attend this meeting virtually, please see below.

IMPORTANT NOTICES

This meeting will be conducted in person at the address listed above. As a convenience to the public, members of the public may also participate virtually by using the **Agency's Call-In Number 1-833-568-8864, Webinar ID: 161 437 8560 or Zoom Webinar by clicking on the link <https://scvwa.zoomgov.com/j/1614378560>**. Any member of the public may listen to the meeting or make comments to the Committee using the call-in number or Zoom Webinar link above. However, in the event there is a disruption of service which prevents the Agency from broadcasting the meeting to members of the public using either the call-in option or internet-based service, this meeting will not be postponed or rescheduled but will continue without remote participation. The remote participation option is being provided as a convenience to the public and is not required. Members of the public are welcome to attend the meeting in person.

Attendees should be aware that while the Agency is following all applicable requirements and guidelines regarding COVID-19, the Agency cannot ensure the health of anyone attending a Committee meeting. Attendees should therefore use their own judgment with respect to protecting themselves from exposure to COVID-19.

Members of the public unable to attend this meeting may submit comments either in writing to ekang@scvwa.org or by mail to Eunie Kang, Executive Assistant, Santa Clarita Valley Water Agency, 26501 Summit Circle, Santa Clarita, CA 91350. All written comments received before 4:00 PM the day of the meeting will be distributed to the Committee members and posted on the Santa Clarita Valley Water Agency website prior to the start of the meeting. Anything received after 4:00 PM the day of the meeting, will be made available at the meeting, if practicable, and will be posted on the SCV Water website the following day. All correspondence with comments, including letters or emails, will be posted in their entirety.

MEETING AGENDA

<u>ITEM</u>	<u>PAGE</u>
1. <u>PLEDGE OF ALLEGIANCE</u>	
2. <u>PUBLIC COMMENTS</u> – Members of the public may comment as to items within the subject matter jurisdiction of the Agency that are not on the Agenda at this time. Members of the public wishing to comment on items covered in this Agenda may do so at the time each item is considered. (Comments may, at the discretion of the Committee Chair, be limited to three minutes for each speaker.)	
3. * Recommend Adoption of a Resolution Approving the SB 610 Water Supply Assessment for the Shadowbox Studios Development	1
4. * Recommend Authorizing the General Manager to Execute a Construction Contract for Bridgeport Pocket Park	173
5. Update on Water Operating Plan and Water Conservation Response Actions	
6. Water Resources Director's Report	
6.1 Status of Water Supply and Water Banking Programs	
6.2 Update on Water Resiliency Plan Initiatives Activities	
6.3 Staff Activities	
7. Sustainability Manager's Report	
7.1 Update on Conservation Activities & Performance	
8. * Committee Planning Calendar	189
9. Adjournment	
* Indicates Attachment	
• Indicates Handout	

NOTICES:

Any person may make a request for a disability-related modification or accommodation needed for that person to be able to participate in the public meeting by telephoning Eunie Kang, Executive Assistant, at (661) 297-1600, or in writing to ekang@scvwa.org or by mail to Eunie Kang, Executive Assistant, Santa Clarita Valley Water Agency, 26501 Summit Circle, Santa Clarita, CA 91350. Requests must specify the nature of the disability and the type of accommodation requested. A telephone number or other contact information should be included so that Agency staff may discuss appropriate arrangements. Persons requesting a disability-related accommodation should make the request with adequate time before the meeting for the Agency to provide the requested accommodation.

Pursuant to Government Code Section 54957.5, non-exempt public records that relate to open session agenda items and are distributed to a majority of the Committee less than seventy-two (72) hours prior to the meeting will be available for public inspection at the Santa Clarita Valley Water Agency, located at 27234 Bouquet Canyon Road, Santa Clarita, CA 91350, during regular business hours. When practical, these public records will also be made available on the Agency's Internet Website, accessible at <http://www.yourscvwater.com>.

Posted on September 7, 2022.

[This page intentionally left blank.]



COMMITTEE MEMORANDUM

DATE: Sept 1, 2022

TO: Water Resources and Watershed Committee

FROM: Steve Cole *SC*
Assistant General Manager

SUBJECT: Recommend Adoption of a Resolution Approving the SB 610 Water Supply Assessment for the Shadowbox Studios Development.

SUMMARY

The City of Santa Clarita Planning Department, acting as lead agency in the preparation of an Environmental Impact Report (EIR) for the Shadowbox Studios Development (Master Case 21-109) (Project) has requested that the Santa Clarita Valley Water Agency (SCV Water) provide an SB 610 Water Supply Assessment (WSA) for the Project. Staff prepared for Board consideration, a Draft WSA for the Project that concludes, consistent with the 2020 Urban Water Management Plan, current and future water supplies are sufficient to meet demands for the Project.

BACKGROUND AND DISCUSSION

SB 610 requires that a Water Supply Assessment (WSA) be prepared for all development projects of 500 or more dwelling units, or that have a commercial footprint of more than 500,000 square feet. It also requires that the “entity serving domestic water supplies whose service area includes the project site” shall prepare the WSA and that “the governing body of each public water system...shall approve the assessment...at a regular or special meeting.” *The most recently adopted Urban Water Management Plan*, along with other planning and analysis documents, should serve as the basis of the WSA.

SCV Water staff has prepared a Draft WSA for the Shadowbox Studios Project. The Draft WSA is included as Exhibit 1 to the attached resolution. The WSA is largely based on the 2020 UWMP with some noted updates to reflect the (1) revised timing for recovery of capacity from certain wells from perchlorate and PFAS contamination and (2) reduced near term average SWP reliability from 58% to 56% as indicated in the recently released SWP Delivery Capability Report. Additionally, the Draft WSA also contains a more in-depth discussion on how climate change and other uncertainties are addressed. Overall, the Draft WSA evaluated the long-term water needs (water demand) within the SCV Water service area and has compared these needs against existing and future water supplies. Demand projections are based on applicable population projections and County and City land use plans, and account for conservation as well as climate change impacts and other relevant factors. Results indicate that the total projected water supplies available to the SCV Water service area through 2050 during normal, single-dry, and multiple-dry year (5-year drought) periods are sufficient to meet the total projected water demands throughout the Valley including that of the proposed Project demands (between 197 & 209 acre-feet per year); provided that SCV Water continues to utilize available SWP Table A Amounts, and will continue to incorporate conjunctive use (coordinated use of surface water and

groundwater), water conservation, water transfers, recycled water, and water banking as part of the total water supply portfolio and management approach to long-term water supply planning and strategy.

The Draft WSA concludes adequate water availability to serve the Project based on a review of numerous water supply planning documents, including the 2020 Urban Water Management Plan, the 2019 California Department of Water Resources Draft State Water Project Delivery Reliability Report and the 2021 SCV Reliability Plan Update. All these sources were used to determine current and future supply and were compared with the anticipated water demand, including those for the proposed Project.

Legal Requirement to Adopt a WSA

As the water supplier for this project, SCV Water is required by Water Code Section 10910(g)(1) to adopt a Water Supply Assessment within 90 days of the request from the County (extensions are allowed). Failure to prepare a WSA subjects SCV Water to a challenge by writ of mandamus. In the WSA, SCV Water must provide detailed information about its existing and planned supplies to support the project and the Board of Directors can conclude one of two things; (1) that water supplies are sufficient to provide water to the project, or (2) that water supplies are insufficient. If the Board of Directors concludes that supplies are insufficient to provide water to the project, the Water Code requires that the WSA include plans, and setting forth measures, for acquiring and developing additional water supplies.

FINANCIAL CONSIDERATIONS

None.

RECOMMENDATIONS

That the Water Resources and Watershed Committee recommends that the Board of Directors approve a resolution adopting the Water Supply Assessment for the Shadowbox Studios Project and direct staff to forward the WSA to the City of Santa Clarita Planning Department.

RGV

Attachments

RESOLUTION NO. SCV-

**RESOLUTION OF THE BOARD OF DIRECTORS OF THE
SANTA CLARITA VALLEY WATER AGENCY
ADOPTING THE SB 610 WATER SUPPLY ASSESSMENT
FOR THE SHADOWBOX STUDIOS DEVELOPMENT
(CITY OF SANTA CLARITA MASTER CASE 21-109)**

WHEREAS, the Santa Clarita Valley Water Agency (SCVWA) provides retail water service to portions of the City of Santa Clarita and to unincorporated portions of Los Angeles County in the Santa Clarita Valley; and

WHEREAS, the SCVWA is a "public water system" as defined by California Government Code section 66473.7(a)(3) and California Water Code section 10912 and may receive requests from time to time to prepare a Water Supply Assessment pursuant to Water Code section 10910 et seq. (commonly referred to as SB 610) and/or a Water Supply Verification pursuant to Government Code section 66473.7 (commonly referred to as SB 221); and

WHEREAS, the SCVWA received a request from the City of Santa Clarita Planning Department for SCVWA to prepare a Water Supply Assessment for a project within the City for County Assessor Parcel Numbers 2834-001-007; 2834-001-012 to -015; 2834-002-046; 2834-003-044; 2834-004-045; 2834-005-041; 2834-006-041; 2834-007-045; 2834-008-039; 2834-010-043; 2834-011-021; 2834-012-023; 2834-013-041; 2834-014-043; 2834-015-021; 2834-016-041; 2834-017-021; 2834-020-111; 2834-020-114; 2834-021-134; 2834-022-067, otherwise referred to as the Shadowbox Studios Development (the Project), where the city is the lead agency for the Project under the California Environmental Quality Act (CEQA) and the city is responsible for all land use decisions related to the Project; and

WHEREAS, the Project is within SCVWA's service area, and therefore SCVWA is the public water system to provide water service to the Project; and

WHEREAS, pursuant to the City's request for SCVWA to prepare a Water Supply Assessment for the Project, SCVWA has prepared a Water Supply Assessment for the Project in accordance with the requirements of Water Code section 10910 et seq.

NOW THEREFORE, BE IT RESOLVED that, the Board of Directors of SCVWA, as the governing body of the Santa Clarita Valley Water Agency, (1) has determined that all of the foregoing Recitals are true and correct and are incorporated herein and made an operative part of this Resolution; (2) has reviewed the Water Supply Assessment for the Project; (3) has determined, exercising its independent judgment, that a "sufficient water supply" is available for the Project based on the requirements of Water Code section 10910 et seq., the information and analyses contained in the Water Supply Assessment, the documentation contained in the administrative record in support of the Water Supply Assessment, and other relevant records on file with SCVWA; and (4) hereby approves the Water Supply Assessment for the Project, a copy of which is attached hereto as Exhibit 1 and incorporated herein by reference.

RESOLVED FURTHER that, the Agency's General Manager or his designee is authorized and directed to forward a copy of the approved Water Supply Assessment to the City of Santa Clarita in response to the City's request, and to take any and all actions necessary in furtherance of the matters authorized or contemplated by the foregoing Resolution.

President

I, the undersigned, hereby certify: That I am the duly appointed and acting Secretary of the Santa Clarita Valley Water Agency, and that at a regular meeting of the Board of Directors of said Agency held on October 4, 2022 the foregoing Resolution No. **SCV-** was duly and regularly adopted by said Board, and that said resolution has not been rescinded or amended since the date of its adoption, and that it is now in full force and effect.

DATED: October 4, 2022

Secretary

DRAFT

Exhibit 1



Water Supply Assessment

Shadowbox Studios Development

City of Santa Clarita
Master Case #21-109

September 1, 2022

Prepared by

**Santa Clarita Valley
Water Agency**

27234 Bouquet Canyon Road
Santa Clarita, CA 91350

Table of Contents

<i>List of Tables</i>	iv
<i>List of Figures</i>	v
<i>List of Appendices</i>	v
<i>List of Acronyms</i>	v

SECTION 1: INTRODUCTION 1-1

1.1 BACKGROUND	1-1
1.2 PURPOSE	1-1
1.3 PROJECT DESCRIPTION	1-2
1.4 SANTA CLARITA VALLEY WATER AGENCY.....	1-3
1.4.1 <i>Water Management Within SCV Water</i>	1-4
1.5 2020 URBAN WATER MANAGEMENT PLAN.....	1-4
1.6 SCV WATER POLICIES AND REGULATORY APPROVALS/PERMITS	1-5
1.7 INFORMATION USED OR RELIED UPON IN PREPARING THIS WSA.....	1-5

SECTION 2: HISTORICAL AND PROJECTED WATER DEMANDS 2-1

2.1 EXISTING AND PROJECTED SCV WATER DEMANDS	2-1
2.2 PROJECTED WATER USE	2-4
2.2.1 <i>Potable Water Use Projections</i>	2-4
2.3 SHADOWBOX STUDIOS DEVELOPMENT PROJECT DEMANDS	2-7

SECTION 3: EXISTING AND PROJECTED WATER SUPPLIES..... 3-1

3.1 IMPORTED WATER SUPPLIES	3-1
3.2 STATE WATER PROJECT SUPPLIES	3-2
3.2.1 <i>SWP Facilities</i>	3-2
3.2.2 <i>SWP Water Supply Contract Amendments</i>	3-2
3.2.3 <i>SWP Water Supplies</i>	3-3
3.2.4 <i>Factors Affecting SWP Table A Supplies</i>	3-5
3.2.5 <i>Biological Opinion</i>	3-7
3.2.6 <i>SWP Table A Supply Assessment</i>	3-9
3.2.7 <i>SWP Water Supply Estimates</i>	3-9
3.2.8 <i>Coordinated Operations Agreement</i>	3-11
3.2.9 <i>Delta Conveyance Project</i>	3-12
3.2.10 <i>Emergency Freshwater Pathway Description (Sacramento-San Joaquin Delta)</i>	3-12
3.2.11 <i>Sisk Dam Raise and San Luis Reservoir Expansion</i>	3-14
3.2.12 <i>SWP Seismic Improvements</i>	3-14
3.2.13 <i>Water Quality Control Plan/Voluntary Agreement</i>	3-14
3.2.14 <i>Delta Reliance</i>	3-15
3.2.15 <i>Other Imported Supplies</i>	3-15
3.2.15.1 <i>Buena Vista-Rosedale Rio Bravo</i>	3-15
3.2.15.2 <i>Nickel Water – Newhall Land</i>	3-16

3.2.15.3 Yuba Accord Water	3-16
3.3 GROUNDWATER	3-16
3.3.1 Santa Clara River Groundwater Basin – East Subbasin.....	3-17
3.3.2 Groundwater Management Planning	3-17
3.3.2.1 Groundwater Sustainability Plan	3-17
3.3.2.2 Groundwater Management Plan	3-18
3.3.2.3 Available Groundwater Supplies	3-19
3.3.2.4 Alluvium.....	3-24
3.3.2.5 Saugus Formation	3-35
3.3.3 Existing and Planned Groundwater Pumping	3-42
3.3.3.1 Impacted Well Capacity.....	3-42
3.3.3.2 Alluvium.....	3-43
3.3.3.3 Saugus Formation	3-44
3.3.3.4 Summary	3-44
3.4 TRANSFERS AND EXCHANGES.....	3-47
3.4.1 Core Transfers.....	3-48
3.4.2 Spot Market Transfers	3-48
3.4.3 Option Contracts.....	3-48
3.4.4 Future Market Transfers	3-48
3.4.5 Water Exchanges	3-48
3.5 GROUNDWATER BANKING PROGRAMS.....	3-50
3.5.1 Semitropic Banking Program	3-50
3.5.2 Rosedale-Rio Bravo Banking Program.....	3-51
3.5.3 Semitropic Banking Program – Newhall Land	3-52
3.5.4 Other Opportunities	3-52
3.6 PLANNED WATER SUPPLY PROJECTS AND PROGRAMS	3-53
3.6.1 Sites Reservoir	3-53
3.7 RECYCLED WATER	3-54
3.7.1 Recycled Water Master Planning Efforts	3-54
3.7.2 Existing Wastewater Treatment Facilities.....	3-56
3.7.3 Wastewater Treatment Facility Improvements and Expansions.....	3-57
3.7.4 New Drop Program	3-57
3.7.5 Instream Flow Requirements.....	3-59
3.7.6 Other Potential Sources of Recycled Water	3-60
3.7.7 Recycled Water Supply and Demand.....	3-61
3.7.8 Recycled Water Demand.....	3-62
3.7.9 Recycled Water Comparison	3-64
3.7.10 Methods to Encourage Recycled Water Use.....	3-64
3.7.11 Optimization Plan for Recycled Water	3-65
3.7.12 Additional Considerations Relating to the Use of Recycled Water	3-65
3.7.13 Capital Outlay Program	3-66

SECTION 4: SUPPLY RELIABILITY PLANNING AND ACCOUNTING FOR UNCERTAINTIES ASSOCIATED WITH GROUNDWATER CONTAMINATION AND OTHER FACTORS 4-1

4.1 WATER QUALITY	4-1
4.2 WATER QUALITY CONSTITUENTS OF INTEREST	4-2
4.2.1 Perchlorate	4-2

- 4.2.2 Per- and Polyfluoroalkyl Substances (PFAS)4-7
- 4.2.3 Metals and Salts4-8
- 4.2.4 Disinfection By-Products.....4-8
- 4.2.5 Total Trihalomethanes4-9
- 4.2.6 Microbiological4-9
- 4.2.7 Radiological Tests4-9
- 4.2.8 Organic Compounds.....4-9
- 4.3 IMPORTED WATER QUALITY4-10
- 4.4 SURFACE WATER QUALITY4-11
- 4.5 GROUNDWATER QUALITY.....4-12
 - 4.5.1 Water Quality – Alluvium4-12
 - 4.5.2 Water Quality – Saugus Formation.....4-13
- 4.6 WATER QUALITY IMPACTS ON RELIABILITY4-13
- 4.7 REVIEW OF PENDING WATER QUALITY PERMITTING FOR SAUGUS WELLS.....4-15
 - 4.7.1 Process Memo 97-005 Requirements4-17
 - 4.7.2 Existing and Future Saugus Wells.....4-18
 - 4.7.2.1 Saugus Well 2014-18
 - 4.7.2.2 Saugus Well 2054-18
 - 4.7.2.3 Saugus Wells 3 and 44-19
 - 4.7.2.4 Saugus Wells 5 and 64-19
 - 4.7.2.5 Saugus Wells 7 and 84-19
 - 4.7.2.6 N-Well4-19
- 4.8 POTENTIAL EFFECTS OF CLIMATE CHANGE4-19
- 4.9 PENDING WATER USE EFFICIENCY4-25
- 4.10 WATER SUPPLY RELIABILITY MODELING.....4-27
- 4.11 WATER CONSERVATION AND WATER SHORTAGE CONTINGENCY PLANNING4-30
- SECTION 5: WATER SUPPLY ASSESSMENT..... 5-1**
 - 5.1 WATER SYSTEM OPERATIONS AND RELIABILITY PLANNING5-1
 - 5.1.1 Historical Operations of Santa Clarita Valley Water System5-4
 - 5.1.2 Average/Normal Year Supplies and Demand Comparison.....5-7
 - 5.1.3 Single Dry Year Supplies and Demand5-8
 - 5.1.4 Multiple Dry Year Supplies and Demand.....5-10
 - 5.2 ADDITIONAL WATER SUPPLY RELIABILITY ANALYSIS5-12
 - 5.3 CONCLUSION.....5-13
- SECTION 6: REFERENCES USED OR RELIED UPON IN PREPARING WSA 6-1**

List of Tables

Table 2-7 Historical Water Use In the SCV Water Service Area (AF)
Table 2-2 Summary of Water Supplies Used in 2020 (AF)
Table 2-3 SCV Water Projected Normal/Average Year Demands (AFY)
Table 2-4 SCV Water Projected Single-Dry Year Demands (AFY)
Table 2-5 SCV Water Projected Multiple-Dry Year Demands (AFY)
Table 2-6 Water Demand Estimates – Shadowbox Studios Development
Table 2-7 Demand Factors Used in Water Supply Assessment Calculations
Table 3-1 SWP Table A Supply Reliability (AF)
Table 3-2 Groundwater Operating Plan For The Santa Clarita Valley
Table 3-3 Recent Historical Groundwater Production (AF)
Table 3-4 Projected Groundwater Production (Normal Year) (AF)
Table 3-4 A Active Municipal Groundwater Source Capacity — Alluvial Aquifer Wells
Table 3-4 B Active Municipal Groundwater Source Capacity – Existing, Future and Recovered Alluvial Aquifer Wells Normal Year Detail (2021-2030)
Table 3-4 C Active Municipal Groundwater Source Capacity – Existing, Future and Recovered Alluvial Aquifer Wells Dry Year Detail (2021-2030)
Table 3-5 A Municipal Groundwater Source Capacity- Existing, Future, And Recovered Saugus Formation Wells
Table 3-5 B Municipal Groundwater Source Capacity- Existing, Future, And Recovered Saugus Formation Wells Normal Year Detail (2021-2030)
Table 3-5 C Municipal Groundwater Source Capacity- Existing, Future, And Recovered Saugus Formation Wells Dry Year Detail (2021-2030)
Table 3-6 Average/Normal Year Existing And Planned Groundwater Usage (AF)
Table 3-7 Single-Dry Year Existing And Planned Groundwater Usage (AF)
Table 3-8 Multiple Dry Year (5-Year) Existing And Planned Groundwater Usage (AF)
Table 3-9 Participating Entities
Table 3-10 Existing And Projected Recycled Water Demand
Table 3-11 Projected Recycled Water Use
Table 3-12 Recycled Water Uses – Projection Compared With Actual Use (AFY)
Table 4-1 Status of Impacted Wells
Table 4-2 Current And Projected Water Supply Changes Due To Water Quality (Percent Change)
Table 4-3 Anticipated Schedule For Permitting And Operation Of Saugus Wells
Table 4-4 Recommended Indoor Water Use Standards
Table 4-5 Various SCV Water Supply Scenarios
Table 5-1 SCV Water Historical Sources of Supply (AFY)
Table 5-2 Projected Average/Normal Year Supplies And Demands (AF)
Table 5-3 Projected Single-Dry Year Supplies And Demands (AF)
Table 5-4 Projected Five-Year Dry Year Supplies and Demands (AF)

List of Figures

Figure 1-1 Project Location Maps

Figure 2-1 Historical Water Use in the SCV Water Service Area (AF)

Figure 3-1 New Drop Program Process

Figure 4-1 Monthly Distribution of ETo Compared to Baseline

Figure 4-2 Monthly Distribution of Precipitation Compared to Baseline

Figure 4-3 Final Reliability Results with Active Conservation

List of Appendices

A. Site Plan

List of Acronyms

AF	Acre-Feet
AFY	Acre-Feet Per Year
AIP	Agreement in Principle
AVEK	Antelope Valley East-Kern Water Agency
Bay-Delta	San Francisco Bay/Sacramento-San Joaquin Delta Estuary
BO	Biological Opinion
BVWSD	Buena Vista Water Storage District
Cal OES	California Office of Emergency Services
CASGEM	California Statewide Groundwater Elevation Monitoring
CCR	California Code of Regulations
CCWA	Central Coast Water Authority
CEC	California Energy Commission
CESA	California Endangered Species Act
CEQA	California Environmental Quality Act
CEPA	California Environmental Protection Agency
CDFW	California Department of Fish and Wildlife
cfs	Cubic Feet Per Second
CII	Commercial, Industrial, Institutional
CLWA	Castaic Lake Water Agency
CNRA	California National Resources Agency
COA	Coordinated Operation Agreement
CORPS	Corps of Engineers
CVP	Central Valley Project

BPD	Disinfection By-Products
DCP	Delta Conveyance Project
DCP	Delivery Capability Report
DDW	Division of Drinking Water
DFW	Department of Fish and Wildlife
DLR	Detection Level for Reporting
DPH	California Department of Public Health
DPR	Direct Potable Reuse
DSS	Decision Support System
DTSC	Department of Toxic Substances Control
DWR	Department of Water Resources
FBR	Fluidized Bed Reactor
FWS	Fish and Wildlife Service
GSA	Groundwater Sustainability Agency
GSP	Groundwater Sustainability Plan
GWMP	Groundwater Management Plan
HET	High Efficiency Toilets
HEU	High Efficiency Urinals
EIR	Environmental Impact Report
EIS	Environmental Impact Statement
ESA	Endangered Species Act
FBR	fluidized bed reactor
GIS	Geographic Information System
HAA5	Haloacetic Acids
KCWA	Kern County Water Agency
IRWMP	Integrated Regional Water Management Plan
LACWWD 36	Los Angeles County Water Works District 36
LARWQCB	Los Angeles Regional Water Quality Control Board
MAF	Million Acre-Feet
MGD	Million Gallons per Day
MGL	Micrograms per Liter
MOU	Memorandum of Understanding
NCWD	Newhall County Water District
NEPA	National Environmental Policy Act
Ng/L	nanograms per liter
NL	Notification Level
NLF	Newhall Land and Farming
NMFS	National Marine Fisheries Service
NPDES	National Pollutant Discharge Elimination System
NOP	Notice of Preparation
NWD	Newhall Water Division
OAL	Office of Administrative Law
OVOV	One Valley One Vision
PFAS	Per- and Polyfluoroalkyl Substances

PFOA	Perfluorooctonic acid
PFOS	Perflurooctane sulfonate
PWAs	Public Water Agencies
RL	Response Level
RRBWSD	Rosedale Rio-Bravo Water Storage District
RWMP	Recycled Water Management Plan
SATP	Saugus Aquifer Treatment Plant
SB	Senate Bill
SCWD	Santa Clarity Water Division
SCVSD	Santa Clarita Valley Sanitation District
SCV Water	Santa Clarita Valley Water Agency
Semitropic	Semitropic Water Storage District
SGMA	Sustainable Groundwater Management Act
SLDMWA	San Luis & Delta Mendota Water Authority
SNMP	Salt and Nutrient Management Plan
SOC	Synthetic organic compounds
SWRCB	State Water Resources Control Board
SWP	State Water Project
SWRU	Stored Water Recovery Unit
THMS	Trihalomethanes
TTHMs	Total Trihalomethanes
TMDL	Total Maximum Daily Load
TOC	Total Organic Carbon
USCR	Upper Santa Clara River
VOC	Volatile Organic Compound
WMT	Water Management Tools
WQOs	Water Quality Objectives
WSA	Water Supply Assessment
WUESP	Water Use Efficiency Strategic Plan
ug/L	micrograms per liter
UIF	Unimpaired Flow
UWCD	United Water Conservation District
USEPA	United State Environmental Protection Agency
USBR	United States Bureau of Reclamation
UWMP	Urban Water Management Plan
UV	Ultra-Violet
WKWD	West Kern Water District
WQR	Water Quality Report
WRP	Water Reclamation Plant
VWC	Valencia Water Company
VWD	Valencia Water Division

Section 1: Introduction

1.1 Background

This Water Supply Assessment (WSA) has been prepared by the Santa Clarita Valley Water Agency (SCV Water) for the Shadowbox Studios Development, a full-service film and television studio campus encompassing approximately 94.5 acres located in the City of Santa Clarita, Los Angeles County, California. The WSA is prepared pursuant to the requirements of California Water Code Sections 10910, et seq., commonly known as Senate Bill 610 (SB 610; Costa; Chap. 643, Stats. 2001) and has been further amended from time to time.

SB 610 amended state law, effective January 1, 2002, to improve the link between information on water supply availability and certain land use decisions made by cities and counties. SB 610 requires that the water purveyor of a public water system prepare a water supply assessment to be included in the environmental documentation of certain proposed projects.

Once a city or county determines that a project, as defined by California Water Code section 10912, is subject to the California Environmental Quality Act, Public Resources Code section 21000, et seq. (CEQA), SB 610 requires the city or county to identify a public water system that may supply water for the project, and request that the public water system prepare a water supply assessment.¹

A “public water system” is defined by the Water Code to mean “a system for the provision of piped water to the public for human consumption that has 3,000 or more service connections.” SCV Water serves piped water to the public (i.e., residents of the Santa Clarita Valley) within its current service area, and the area includes about 73,542 service connections in the City of Santa Clarita and in the unincorporated Los Angeles County communities. As a result, SCV Water is the “public water system” for the purposes of this WSA.

As noted above, a WSA is required for any “project” as defined by Water Code Section 10912 that is subject to CEQA. In this case, the Project proposes, among other things, a residential development of more than 500 dwelling units, and therefore a WSA is required.² SCV Water is the retail purveyor for the Project site, and thus SCV Water is required to prepare a WSA for the Project, pursuant to a request by CEQA lead agency the County of Los Angeles.³

1.2 Purpose

The general purpose of a WSA is to evaluate the following question:

Whether the public water system’s total projected water supplies available during normal, single-dry, and multiple-dry water years during a 20-year projection will meet the projected water demand of the

¹ California Water Code §§ 10910(b), 10910(c)(1).

² Water Code § 10912(a)(1). This section also includes other types of development that are defined as a “project” by this section of the code.

³ Water Code § 10910(b).

*Project, in addition to the public water system's existing and planned future uses, including agricultural and manufacturing uses.*⁴

If, as a result of its WSA, the public water system concludes that its water supplies are or will be insufficient, the public water system must provide to the applicable land use authority its plans for acquiring additional water supplies, setting forth the measures being undertaken to acquire and develop those supplies.⁵ The WSA must include, among other information, an identification of any existing water supply entitlements, water rights, or water service contracts relevant to the identified water supply for the project, and water received in prior years by the public water system pursuant to those entitlements, rights, or contracts.⁶

The WSA is required to be included in any environmental document prepared for the project pursuant to CEQA.⁷ In this case, the City of Santa Clarita is the lead agency under CEQA, and it has determined that an Environmental Impact Report (EIR) is required for the Project; thus, this WSA will be included as part of the Shadowbox Studios Development Draft EIR. This WSA evaluates water supplies that are or will be available during normal, single-dry, and multiple-dry water years during a 30-year projection to meet existing demands, expected demands of the Project, and reasonably foreseeable planned future water demands served by SCV Water.

1.3 Project Description

The Shadowbox Studios Development Project (City of Santa Clarita Master Case No. 21-109) generally located at the northwest corner of 13th Street and Arch Street (Assessor Parcel Numbers 2834-001-007; 2834-001-012 to -015; 2834-002-046; 2834-003-044; 2834-004-045; 2834-005-041; 2834-006-041; 2834-007-045; 2834-008-039; 2834-010-043; 2834-011-021; 2834-012-023; 2834-013-041; 2834-014-043; 2834-015-021; 2834-016-041; 2834-017-021; 2834-020-111; 2834-020-114; 2834-021-134; 2834-022-067). The project applicant, L.A. Railroad 93, LLC, proposal consists of a full-service film and television studio campus (Shadowbox Studios) on the 94.5 acre Project Site that would consist of approximately 473,000 square feet of sound stages; approximately 561,500 square feet of workshops, warehouses, and support uses; approximately 221,000 square feet of production and administrative offices; approximately 37,500 square feet of catering and other specialty services and 17 acres of irrigated landscape. Upon completion, the campus would have an overall building area of approximately 1,293,000 square feet. As shown in Figure 1-1, the Project Site lies in the southwestern portion of Santa Clarita, in the Newhall community, and is located approximately 2 miles east of Interstate 5 (I-5), 2 miles west of the Antelope Valley Freeway (State Route 14), and 2 miles south of the Santa Clara River. As shown in Figure 2, Project Vicinity Map, the Project Site is situated at the northeast corner of Railroad Avenue and 13th Street and bounded by 12th Street, Arch Street, and 13th Street on the south; Railroad Avenue on the west; Metropolitan Water District (MWD) right-of-way (ROW) on the east; and HOA maintained slopes associated with adjacent residential uses to the north. The total estimated water demand for the Project at build-out is approximately 197 AFY in an average/normal year.

The Project Site Plan is shown in Appendix A.

⁴ Water Code § 10910(c).
⁵ Water Code § 10911(a).
⁶ Water Code § 10910(d).
⁷ Water Code § 10911(b).

Figure 1-1 Project Location Maps

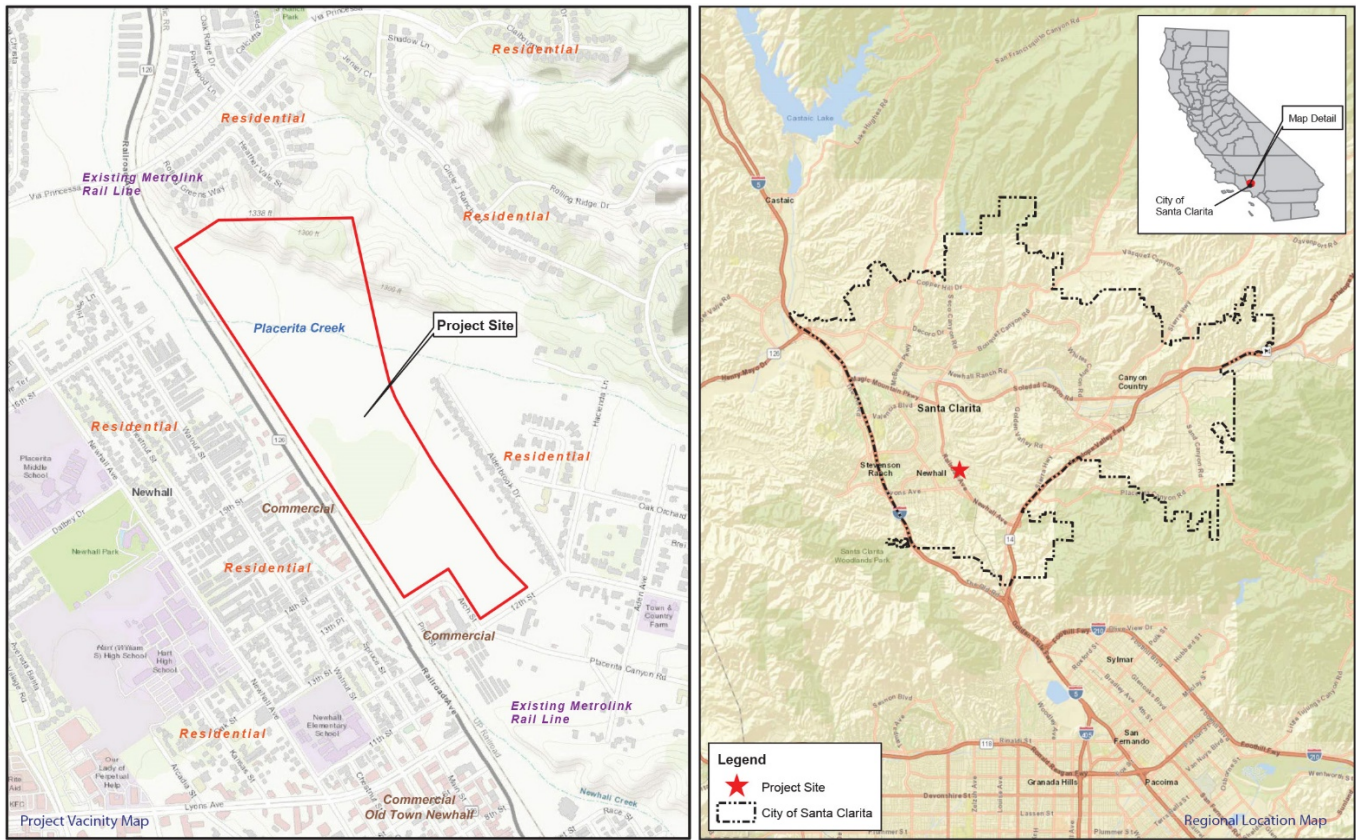

1.4 Santa Clarita Valley Water Agency

SCV Water is located in the northwestern portion of Los Angeles County. SCV Water is the regional water wholesaler and retailer for the Santa Clarita Valley. The Project site is located within SCV Water's service area and therefore, SCV Water is the water supplier for the Project.

SCV Water's service area includes nearly the entire city of Santa Clarita and unincorporated portions of Los Angeles County. SCV Water's current service area includes a mix of residential and commercial, and light industrial land uses, mostly comprised of single-family homes, apartments, condominiums, and several local shopping centers and neighborhood commercial developments. SCV Water serves approximately 73,542 service connections. SCV Water generally meets potable water demands using a mix of local groundwater, banked groundwater supplies, imported State Water Project (SWP) water and other imported supplies. Recycled water is delivered to some customers for non-potable uses, such as landscape irrigation.

The groundwater basin in the Santa Clarita Valley is unadjudicated, meaning that SCV Water does not have specific adjudicated, or defined, water rights or specific limitations that dictate its water supply. However, in practice, SCV Water assesses available groundwater supplies pursuant to appropriate groundwater rights in the basin and in accordance with a groundwater operating plan developed by SCV Water and other retail water purveyors in the Santa Clarita Valley and complemented by analyses based on a numerical groundwater flow model of the basin. SCV Water is also a member of the Santa Clarita

Valley Groundwater Sustainability Agency (SCV-GSA) for the Santa Clara River East Subbasin. In preparing the basin's Groundwater Sustainability Plan (GSP), it conducted additional numeric modeling that further refined the groundwater operating plan for the basin as further discussed in Section 3.3.2.1.

1.4.1 Water Management Within SCV Water

SCV Water was formed on January 1, 2018, when the Castaic Lake Water Agency (CLWA), which included Santa Clarita Water Division (SCWD) and Newhall County Water District (NCWD), merged to become a single agency pursuant to state legislation (SB 634, Chapter 833 2017). Later in January 2018, Valencia Water Company (VWC) was dissolved, and its assets were transferred to SCV Water. The SCV Water service area is shown on Figure 1-1. The formation of SCV Water occurred through a collaborative process. Until the merger, CLWA served as the regional wholesaler to the Santa Clarita Valley, encompassing a service area of 195 square miles in Los Angeles and Ventura Counties. SCV Water now serves the same service area and is made up of three water divisions with separate but interconnected distribution systems: NWD, SCWD, and VWD. Those divisions cover nearly the entire City of Santa Clarita and unincorporated portions of Los Angeles County. In addition, SCV Water serves as a wholesale water provider to LACWWD 36 whose service area includes the Hasley Canyon and the Val Verde communities in the Los Angeles County unincorporated area. LACWWD 36, which is in the SCV Water service area, relies primarily on its own groundwater. SCV Water provides imported water as a supplemental supply.

1.5 2020 Urban Water Management Plan

Pursuant to SB 610 requirements, if the projected water demand associated with the proposed project was accounted for in the most recently adopted Urban Water Management Plan (UWMP),⁸ then relevant information from that document may be incorporated into the WSA. The 2020 UWMP was adopted by the SCV Water Board of Directors in June 2021 and filed with DWR.⁹ It is noted that since the 2020 UWMP was submitted to DWR in 2021, additional information has become available which staff incorporated into this WSA. These updates primarily reflect revised SWP reliability data, that became available from the December 31, 2021 Draft SWP Delivery Capability Report (DCR) (see Section 3.2.7 SWP Water Supply Estimate) as well as updated planning, construction and permitting schedule for several groundwater well recovery projects (see Section 3.3.2.3 Available Groundwater Supplies) The 2020 UWMP information was therefore updated to provide the SCV Water Board with the most current information when it considers adoption of this WSA.

The 2020 UWMP is a planning document covering the SCV Water service area. The 2020 UWMP encouraged extensive public participation that included information dissemination; public workshops, meetings, and hearings; plan adoption; and plan submittal to DWR. The 2020 UWMP includes the following ten major sections:

- Section 1: Introduction
- Section 2: Water Use
- Section 3: SBX7-7 Baseline, Targets, and 2020 Compliance
- Section 4: Water Resources
- Section 5: Recycled Water
- Section 6: Water Quality

⁸ California Urban Water Management Planning Act (UWMP Act), Water Code § 10610, et seq.

⁹ The 2020 UWMP, Section 1.

- Section 7: Reliability Planning
- Section 8: Demand Management Measures
- Section 9: Catastrophic Interruptions in Water Service
- Section 10: References

Consistent with the UWMP Act, the 2020 UWMP accomplishes water supply planning over the required 20-year period in five-year increments. While not required, SCV Water exceeded the requirements of the UWMP Act by including a span of 30 years in the 2020 UWMP, extending out to 2050. The 2020 UWMP identifies and quantifies adequate water supplies for existing and future demands, in normal/average, single-dry, and multiple-dry years, and describes implementation of conservation and efficient use of urban water supplies.

The Project's total projected water demand was accounted for in the 2020 UWMP because the timing of the Project places it within the time frame for calculating "planned future uses" within the 2020 UWMP. Also, in order to estimate demand out to 2050 (assumed year of designated land use-buildout), population and water use projections were made based upon existing land uses and planned land use development compiled for the service area, including the City of Santa Clarita and County of Los Angeles land use plans, also known as the One Valley One Vision general plan (OVOV). The Project is located within the city limits of the City of Santa Clarita and is covered by the OVOV. It is SCV Water's understanding that this development is contained in and consistent with the OVOV plan. As the UWMP is based on the housing and commercial development projected in the OVOV plan, the project's water demand has already been incorporated into the existing UWMP demand projections. This information is incorporated by reference in this WSA and can be found on SCV Water's website at <https://yourscvwater.com/uwmp/>. Demands for the Project are included in Section 2.3 of this WSA.

1.6 SCV Water Policies and Regulatory Approvals/Permits

SCV Water Policies. The Project will be subject to all SCV Water policies that govern development and connection to the SCV Water public water system. As with other projects within its service area, the Project applicant is responsible for making appropriate financial and contractual arrangements with SCV Water to assure the necessary improvements are made to the water supply infrastructure to serve the Project site.

Other Regulatory Approvals/Permits. SCV Water is regulated by the State Water Resources Control Board – Division of Drinking Water (DDW) and must meet rigorous water quality standards. In addition, the Project is located within the city limits of the City of Santa Clarita, therefore the City of Santa Clarita will evaluate the Project, conduct extensive environmental oversight, and review, and independently determine the sufficiency of the water supplies to serve the Project site. (Water Code § 10911(b)-(c).) In doing so, the city will determine if the Project will be provided with an acceptable level of water supply based on the criteria set forth in the General Plan, because the Project is located within the Santa Clarita Valley, and because it includes a subdivision map application. In making this determination, the city may use water-related data set forth in documents such as the 2020 UWMP and other information provided by SCV Water.

1.7 Information Used or Relied Upon in Preparing this WSA

This WSA used or relied on information contained in the documents listed below. Documents may be available online or by contacting the SCV Water - Water Resources Department at (661) 297-1600. The documents are part of SCV Water's record for the preparation of this WSA.

- California Department of Water Resources, 2021 Draft State Water Project Delivery Capability Report
- California Department of Water Resources 2019 State Water Project Delivery Capability Report
- California Department of Water Resources. 2018. Delta Flood Emergency Plan.
- California Department of Water Resources. 2018a. Guidance for Climate Change Data Use During Groundwater Sustainability Plan Development
- California Department of Water Resources. November 2011. “Climate Change Handbook for Regional Water Planning”
- California Department of Water Resources, 2016. Bulletin 118 – Update 2016
- California Department of Water Resources and the Army Corps of Engineers, 2019. Delta Emergency Integration Plan.
- California Department of Water Resources Climate Change Technical Advisory Group (CCTAG). 2015. Producing Scientific and Strategic Guidance for California's Department of Water Resources
- California Division of Drinking Water, November 1997. Policy Memo 97-005: Policy Guidance for Direct Domestic Use of Extremely Impaired Sources
- California Ocean Protection Council. 2018. Sea-Level Rise Guidance
- California Office of Emergency Services (Cal OES). 2018. Northern California Catastrophic Flood Response Plan
- California State Water Resources Control Board, 2000. Revised Water Right Decision 1641
- Carollo Engineers, June 2015. Santa Clarita Valley Water Agency Water Resources Reconnaissance Study
- CH2M Hill, 2004a. Regional Ground water Flow Model for the Santa Clarita Valley, Model Development and Calibration
- CH2M Hill, 2004 b. Analysis of Perchlorate Containment in Ground water Near the Whittaker-Bermite Property, Santa Clarita, California, Prepared in support of the 97-005 Permit Application
- CH2M Hill, 2005a. Technical Memorandum, Calibration Update of the Regional Ground Water Flow Model for the Santa Clarita Valley, Santa Clarita, California
- CH2M Hill and Luhdorff & Scalmanini, Consulting Engineers, 2005. Analysis of Ground Water Basin Yield, Upper Santa Clara River Groundwater Basin, East Subbasin, Los Angeles County, California, prepared for Upper Basin Water Purveyors
- Geoscience. 2014. Salt and Nutrient Management Plan for the Upper Santa Clara River Groundwater Basin Volumes 1 and 2
- Geosyntec Water Supply Reliability Plan, 2021
- GSI Water Solutions (GSI), Inc. 2022. Santa Clara River Valley East Groundwater Sustainability Plan
- GSI Water Solutions (GSI), Inc. 2020a. Water Budget Development for the Santa Clara River Valley East Groundwater Subbasin, Draft Technical Memorandum
- GSI Water Solutions, Inc. 2020. Development of a Numerical Groundwater Flow Model for the Santa Clara River Valley East Groundwater Subbasin

- GSI & LSCE. 2014. Draft Report: Perchlorate Containment Plan for Well V201 and Saugus Formation Groundwater in the Santa Clarita Valley (Task 3 of the Well V201 Restoration Program)
- Kennedy/Jenks Consultants. 2021. Santa Clarita Valley Water Agency Groundwater Treatment Implementation Plan
- Kennedy/Jenks Consultants. 2021. Santa Clarita Valley 2020 Urban Water Management Plan
- Kennedy/Jenks Consultants. 2002. Recycled Water Master Plan Update
- Kennedy/Jenks Consultants. 2016a. Recycled Water Master Plan Update
- Kennedy/Jenks Consultants. 2016b. Santa Clarita Valley Recycled Water Rules and Regulations Handbook
- Kennedy/Jenks Consultants. 2015. Final Preliminary Design Report for the Recycled Water System Phase 2B
- Kennedy/Jenks Consultants. 2014 and 2018 Update. Integrated Regional Water Management Plan for the Upper Santa Clara River Region
- Los Angeles Regional Water Quality Control Board (LARWQCB). 1994. Water Quality Control Plan: Los Angeles Region Basin Plan for the Coastal Watersheds of Los Angeles and Ventura Counties, 2020 version
- Luhdorff & Scalmanini, Consulting Engineers, 2021. 2020 Santa Clarita Valley Water Report
- Luhdorff & Scalmanini, Consulting Engineers, 2020. 2019 Santa Clarita Valley Water Report
- Luhdorff & Scalmanini and GSI Water Solutions. August 2009. Analysis of Ground Water Supplies and Ground water Basin Yield, Upper Santa Clara River Ground Water Basin, East Subbasin
- Luhdorff and Scalmanini, 2005. Consulting Engineers, Impact and Response to Perchlorate Contamination, Valencia Water Company Well Q2, prepared for Valencia Water Company
- Luhdorff & Scalmanini, Consulting Engineers, December 2003. Ground Water Management Plan for the Santa Clara Valley Ground Water Basin, East Subbasin
- M&N. 2007. Levee Repair, Channel Barrier, and Transfer Facility Concept Analyses to Support Emergency Preparedness Planning
- Maddaus Water Management (MWM), Inc. 2021. Draft 2021 SCV Demand Study: Land-Use-Based Demand Forecast Analysis
- Maddaus Water Management (MWM), Inc. 2016. SCV Demand Study Update: Land-Use Based Demand Forecast, Final Technical Memorandum No.2
- Maddaus Water Management (MWM), Inc. 2015. SCV Family of Water Supplies Water Use Efficiency Strategic Plan
- Richard C. Slade & Associates, LLC, 2001 Update Report, Hydrogeologic Conditions in the Alluvial and Saugus Formation Aquifer Systems, prepared for Santa Clarita Valley Water Purveyors, July 2002
- Sanitation Districts of Los Angeles County, 2013. Santa Clarita Valley Sanitation District Chloride Compliance Facilities Plan and Environmental Impact Report
- Santa Clarita Valley Water Agency (SCVWA). 2021. Water Supply Reliability Plan Update, prepared by Geosyntec

- Santa Clarita Valley Water Agency (SCVWA). 2021. 2020 Urban Water Management Plan for Santa Clarita Valley Water Agency
- Santa Clarita Valley Water Agency (SCVWA). 2021. Final Water Shortage Contingency Plan
- Santa Clarita Valley Water Agency (SCVWA), July 2015. Castaic Lake Water Agency 2015 Strategic Plan, 2017 Addendum
- Sites Program Management Team. 2020. Sites Reservoir Value Planning Report
- Slade, R. C. Hydrogeologic Assessment of the Saugus Formation in the Santa Clara Valley of Los Angeles County, California, Vols. I and II, prepared for Castaic Lake Water Agency, 1988
- Slade, R. C. Hydrogeologic Investigation of Perennial Yield and Artificial Recharge Potential of the Alluvial Sediments in the Santa Clarita River Valley of Los Angeles County, California, Vols. I and II, prepared for Upper Santa Clara Water Committee, 1986
- Wang, Jianzhong, Hongbing Yin, Erik Reyes, Tara Smith, Francis Chung (California Department of Water Resources). 2018. Mean and Extreme Climate Change Impacts on the State Water Project. California's Fourth Climate Change Assessment. Publication number: CCA4-EXT-2018-004
- Woodard and Curran, 2021. Recycled Water Seasonal Storage Study Technical Memo, January 14, 2021
- Santa Clarita Valley Water Agency State Water Contract with the Department of Water Resources (DWR)
- Santa Clarita Valley Water Agency 2014, Agreement in Principle with the Department of Water Resources for extension of contracts, September 12, 2014
- Department of Water Resources Contract Extension Amendment, February 2019
- Santa Clarita Valley Water Agency 2015, Agreement with Ventura County for use of their Flexible Storage Account
- Department of Water Resources Coordinated Operations Agreement with the Bureau of Reclamation, 1986
- Department of Water Resources Addendum to the Coordinated Operations Agreement with the Bureau of Reclamation, December 2018
- Santa Clarita Valley Water Agency Transfer Agreement with Buena Vista Water Storage District and Rosedale Rio Bravo Water Storage District
- Santa Clarita Valley Water Agency 2018, Yuba Accord Agreement
- Santa Clarita Valley Water Agency Two-for-One Water Exchange Program with Antelope Valley-East Kern Water Agency (AVEK), 2019
- Santa Clarita Valley Water Agency Two-for-One Water Exchange Program with United Water Conservation District, 2019
- Santa Clarita Valley Water Agency Agreement with Semitropic Water Storage District for participation in the Storage Water Recovery Unit (SWRU), 2015
- Santa Clarita Valley Water Agency Water Banking and Exchange Program Agreement with Rosedale Rio Bravo Water Storage District, 2005-2015
- Santa Clarita Valley Water Agency contract with the Santa Clarita Valley Sanitation District
- Santa Clarita Valley Water Agency, Biennial Budget for FY 2021/22, and FY 2022/23

Section 2: Historical and Projected Water Demands

This section describes historical and projected water use in the SCV Water service area and the methodology used to project future demands within SCV Water service area. In order to estimate demand out to 2050 (assumed year of designated land use-buildout), population and water use projections were made based upon existing land uses and planned land use development compiled for the service area, including the City of Santa Clarita and County of Los Angeles land use plans, also known as the One Valley One Vision general plan (OVOV). The Shadowbox Studios Development project is located in the City of Santa Clarita and covered by the OVOV. It is SCV Water's understanding that this development is contained in and consistent with the OVOV plan. As the UWMP is based on the housing and commercial development projected in the OVOV plan, the project's water demand has already been incorporated into the existing UWMP demand projections. In addition, weather and water conservation effects on water usage were considered for this WSA consistent with the approach of the 2020 UWMP.

2.1 Existing and Projected SCV Water Demands

As part of the 2020 UWMP update, an analysis was performed that combined growth projections with water use data to forecast total water demand in future years. Water uses were broken out into specific categories and assumptions were made to accurately project water use over the next 30 years. The demand projections include econometric modeling and plumbing code changes and assume that water conservation programs will continue to be implemented. Climate change impacts on demands were assessed and incorporated in the demand projections. These projections were based on the 2021 Maddaus Technical Memorandum, which serves as the land-use demand forecast for SCV Water and its service area. The historical potable water demands for SCV Water's service area are shown in Table 2-1 and graphically in Figure 2-1. The current water use in SCV Water's service area (2020) is shown in Table 2-2.

**TABLE 2-1
HISTORICAL WATER USE IN THE SCV WATER SERVICE AREA (AF)^(a)**

Year	Population^(d)	SCV Water	LACWWD 36^(b)	Total
1995	161,234	45,196	477	45,673
1996	164,417	49,614	533	50,147
1997	168,825	53,388	785	54,173
1998	173,802	48,280	578	48,858
1999	179,260	56,596	654	57,250
2000	186,236	60,188	800	60,988
2001	196,619	59,784	907	60,691
2002	206,400	67,156	1,069	68,225
2003	215,779	66,272	1,175	67,447
2004	227,823	71,062	1,234	72,296
2005	237,065	69,568	1,200	70,768
2006	242,464	72,837	1,289	74,126
2007	247,194	76,086	1,406	77,492
2008	248,909	74,546	1,354	75,900
2009	250,624	68,731	1,243	69,974
2010	254,548	62,925	1,141	64,066
2011	257,095	63,633	1,172	64,805
2012	259,730	68,447	1,265	69,712
2013	260,377	72,164	1,296	73,460
2014	265,061	66,936	1,242	68,178
2015	266,530	53,515	976	54,491
2016	269,220	56,916	1,050	57,966
2017	271,940	62,461	1,094	63,555
2018	274,660	64,011	1,209	65,220
2019	277,305	69,098	979	70,077
2020	280,588	64,734	1,262	65,996
2021 ^(c)	286,868	67,470	1,244	68,714

Source: 2019 Santa Clarita Valley Water Report (July 2020) and 2020 and 2021 data provided by SCV Water and LACWWD 36.

Notes:

- (a) Total potable and non-potable water use.
- (b) LACWWD 36 is included for purposes of providing regional completeness; however, it is not required to prepare an UWMP.
- (c) Does not include required groundwater discharge to the stormwater system during initial operation at multiple SCV Water Groundwater Treatment Facilities
- (d) Population does not include LACWWD 36

**FIGURE 2-1
HISTORICAL WATER USE IN THE SCV WATER SERVICE AREA (AF)^(a)**

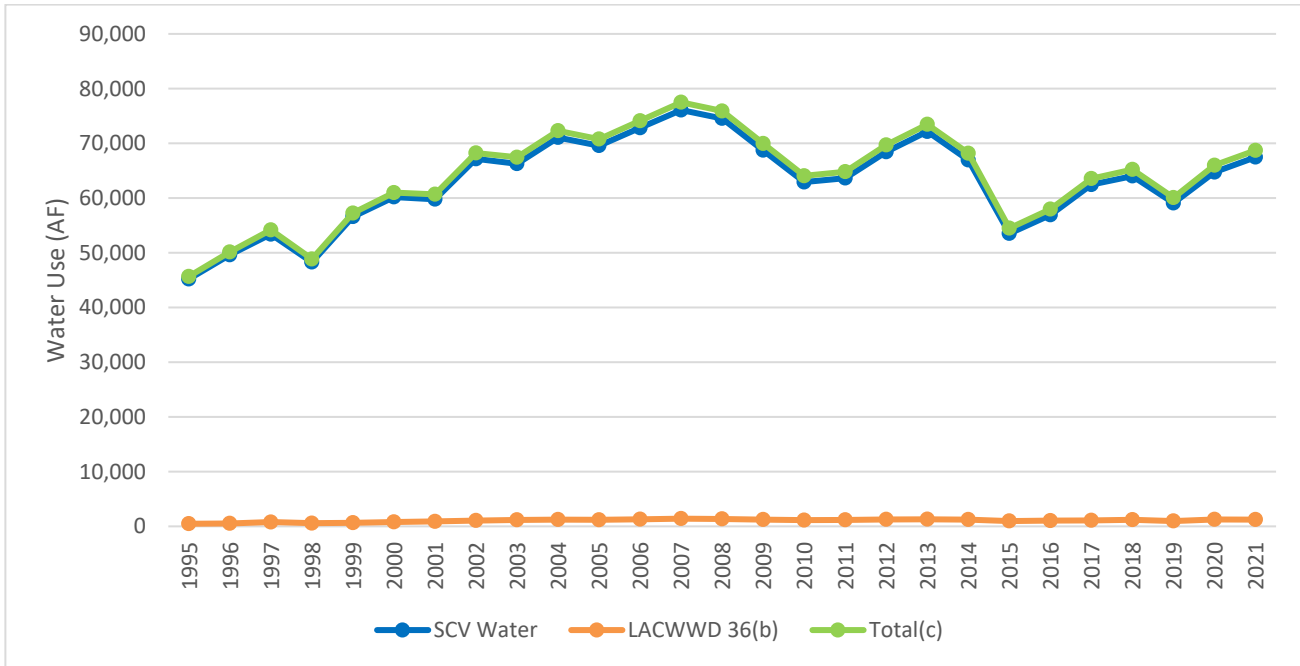

(a) Source: 2019 Santa Clarita Valley Water Report (July 2020) and 2020 and 2021 data provided by SCV Water and LACWWD 36.

Note: Water use shown here includes potable and non-potable (recycled water) use. Recycled water makes up less than 1 percent of total use.

**TABLE 2-2
SUMMARY OF WATER SUPPLIES USED IN 2021 (AF)**

	2021^(a)
Existing Groundwater	
Alluvial Aquifer	14,067
Saugus Formation	11,478
Total Groundwater^(b)	25,545
Recycled Water	
Total Recycled	480
Imported Water	
State Water Project	7,510
Buena Vista-Rosedale	9,685
Yuba Accord Water	1,253
SWC Dry Year Transfer Program	208
Total Imported	18,656
Existing Banking and Exchange Programs	
Rosedale Rio-Bravo Bank	16,320
Semitropic Bank	5,000
Rosedale Rio-Bravo Exchange	0
Antelope Valley East Kern Water Agency Exchange	0
West Kern Exchange	0
Total Bank/Exchange	21,320
Total Supplies	66,001

Notes:

- (a) Actual 2021 supplies utilized. These values are not indicative of available future supplies
- (b) Reflects temporary greater pumping of Saugus Formation to mitigate for lost Alluvial Aquifer pumping pending installation of PFAS treatment described in Tables 3-4A, 3-4B, 3-4C, 3-5A, 3-5B and 3-5C. Additional details on water quality impacts to groundwater supply availability is provided in Section 3.3.

2.2 Projected Water Use

The demand projections for the SCV Water service area have been estimated through 2050. For the UWMP, a land use-based approach was used (which incorporates information from a population-based approach) because such an approach can further reflect assumptions regarding how future development is planned. It can also demonstrate how water usage patterns have evolved from what they were in the past as the Santa Clarita Valley approaches buildout.

2.2.1 Potable Water Use Projections

Potable water use projections are based on a combination of SCV Water and LACWWD 36 demands. For SCV Water's three retail water divisions, the potable demand forecast was determined from land-use-based estimates from 2020 through 2050 (buildout). The land use-based estimates were determined in a

2-4

land use analysis that compiled data from planned development contracts and the OVOV General Plan. In general, the land use analysis leveraged the following information:

- Estimated dwelling units provided by City of Santa Clarita and Los Angeles County Planning Department,
- Land use-based GIS map shape files from City of Santa Clarita and Los Angeles County planners for determining the appropriate number of dwelling units and non-residential building area,
- Queries from GIS maps to determine dwelling units were multiplied by persons per household from the U.S. Census appropriate to each retailer's service area,
- Monthly billing data by customer category (single-family, multi-family, non-residential, etc.),
- Climate and economic adjustment factors for normalizing demands, and
- Future demand factors.

The LACWWD 36 potable demand projections relied on a population-based approach using OVOV-based population estimates. Based on these estimates for SCV Water and LACWWD 36, potable demand projections were developed using a Least Cost Planning Decision Support System Model (DSS Model), which incorporates econometric-based adjustments to better develop an accurate forecast through the year 2050. The DSS Model accounts for existing and future potable water consumption by water customers and estimated passive and active water conservation savings. Demand adjustments include accounting for climate change, drought rebound, weather normalization, work-at-home trends, and overwatering/irrigation equipment efficiency degradation.

In addition, recent legislation provides that, where available, demand projections “shall” display and account for the water savings estimated to result from adopted codes, standards, ordinances, or transportation and land use plans identified by the urban water supplier, as applicable to the service area. If such information is reported, the assessment will provide citations of the various codes, standards, ordinances, or transportation and land use plans utilized in making the projections. The UWMP must indicate the extent that the demand projections consider savings from codes, standards, ordinances, or transportation and land use plans (referred to as savings from passive conservation).

The demand forecast conducted for the UWMP accounts for savings from passive conservation and active conservation. Passive conservation savings focus on plumbing code change impacts on indoor fixtures and include the following laws, codes, and regulations:

- National Plumbing Code (also known as the Energy Policy Act) – Passed in 1992, has long required more efficient plumbing fixtures to be for sale throughout the United States.
- Assembly Bill (AB) 715 – California Plumbing Code includes the new California Code of Regulations (CCR) Title 20 Appliance Efficiency Standards requiring High Efficiency Toilets and High Efficiency Urinals to be exclusively sold in the state by January 1, 2014.
- SB 407 and SB 837 – SB 407 addresses plumbing fixture retrofits on resale or remodel, requiring single family residential property owners of pre-1994 buildings or dwelling units to replace existing plumbing fixtures with water conserving fixtures by 2017 and multi-family and commercial property owners of pre-1994 buildings to replace fixtures by 2019. It also requires all owners to upgrade existing buildings upon any remodel initiated after January 1, 2014 and

authorizes the enactment of local ordinances for greater water savings. SB 837 (enacted in 2011) requires that sellers of real estate property disclose on their Real Estate Transfer Disclosure Statement whether their property complies with these requirements. Both laws are intended to accelerate the replacement of older, low efficiency plumbing fixtures, and ensure that only high efficiency fixtures are installed in new residential and commercial buildings.

- 2019 CALGreen and 2015 California Code of Regulations Title 20 Appliance Efficiency Regulations – Fixture characteristics in the DSS Model are tracked in new accounts, which are subject to the requirements of the 2019 California Green Building Code and 2015 California Code of Regulations Title 20 Appliance Efficiency Regulations adopted by the California Energy Commission (CEC) on September 1, 2015. The CEC 2015 appliance efficiency standards apply to the following new appliances, if they are sold in California: showerheads, lavatory faucets, kitchen faucets, metering faucets, replacement aerators, wash fountains, tub spout diverters, public lavatory faucets, commercial pre-rinse spray valves, urinals, and toilets. The DSS Model accounts for plumbing code savings due to the effects these standards have on showerheads, faucet aerators, urinals, toilets, and clothes washers.
- AB 1881 – State Model Water Efficient Landscape Ordinance adopted by the City of Santa Clarita effective January 1, 2010; improves efficiency in water use in new and existing urban irrigated landscapes.

The conservation savings analysis includes SCV Water’s current active water conservation measures and also passive water savings such as indoor plumbing code measures as follows:

- | | |
|--|------------------------------------|
| • Fixture Retrofit on Resale or Water Account Change | • Smart Controller Rebates |
| • New Development Submetering | • Irrigation Incentives |
| • Landscape & Irrigation Codes | • Irrigation Check-Ups |
| • Water Waste Implementation | • Pool Cover Rebates |
| • AMI | • Residential Check-Ups |
| • Real Water Loss Reduction | • Hot Water on Demand Rebate |
| • Education | • CII Check-Ups |
| • Water Smart Workshop Credit | • CII HET and HEU Rebates |
| • Landscape Transformation Incentives | • High Efficiency Fixture Giveaway |
| | • Schools Retrofits |

This active conservation methodology is an update from SCV Water’s 2016 Water Use Efficiency Strategic Plan (WUESP) and the 2015 UWMP analysis.

Table 2-3 provides a summary of the projected total water use for the SCV Water service area in a normal/average water year. Table 2-4 provides projected demands in a single-dry year and Table 2-5 provides demands in a multiple-dry year.

Additional details of the demand projections analysis are provided in the 2021 Maddaus Technical Memorandum (Maddaus 2021).

TABLE 2-3
SCV WATER PROJECTED NORMAL/AVERAGE YEAR DEMANDS (AFY)^{(a)(b)}

Year	2025	2030	2035	2040	2045	2050
Total Water Use	76,400	81,700	88,700	93,600	97,500	101,000

Source: Maddaus Water Management (MWM), Inc. 2021. Draft 2021 SCV Demand Study: Land-Use-Based Demand Forecast Analysis. April. Table 5 Estimated total demand with active conservation and plumbing code savings. Demands include climate change and recycled water.

^a LACWWD 36 is included for purposes of providing regional completeness; however, it is not required to prepare an UWMP.

^b Demands include the Shadowbox Studios Development Project.

TABLE 2-4
SCV WATER PROJECTED SINGLE-DRY YEAR DEMANDS (AFY)^{(a)(b)(c)}

Year	2025	2030	2035	2040	2045	2050
Total Water Use	81,000	86,600	94,000	99,200	103,400	107,100

Source: WSA5-3. Demands include savings from plumbing code and standards, and active conservation. Demands account for an estimated increase from climate change.

^a LACWWD 36 is included for purposes of providing regional completeness; however, it is not required to prepare an UWMP.

^b Demands include the Shadowbox Studios Development Project

^c Demands assume a 6% increase above normal demand during dry years.

TABLE 2-5
SCV WATER PROJECTED MULTIPLE-DRY YEAR DEMANDS (AFY)^{(a)(b)(c)}

Year	2025	2030	2035	2040	2045	2050
Total Water Use	77,830	83,620	90,570	95,780	99,670	102,870

Source: WSA Table 5-4.

^a LACWWD 36 is included for purposes of providing regional completeness; however, it is not required to prepare an UWMP.

^b Demands include the Shadowbox Studios Development Project.

^c Demands are weather adjusted for dry 1988-1992 hydrology.

2.3 Shadowbox Studios Development Project Demands

Using SCV Water’s water demand factors from 2021 Maddaus Technical Memorandum, the total estimated water demand for the Project at build-out is approximately 197 AFY in an average/normal year. Water demand for the Project at build-out may increase by approximately six percent in a single dry year to a total of 209 AFY and approximately two percent in multiple dry years to a total of 201 AFY, consistent with projections from SCV Water’s 2020 UWMP. The total estimated water demand for the Project at build-out is summarized in Table 2-6 below.

TABLE 2-6
WATER DEMAND ESTIMATES - SHADOWBOX STUDIOS
Projected Normal/Average Year Demands

Unit	# Of units	Unit Type	Demand (AFY)
Landscape Irrigation	17.1	Acres	55.7
Commercial/Office	266	TSF	64.8
Industrial	1018	TSF	76.2
Total Average Year Demands (AFY)			197
Projected Single Dry Year Demands (AFY)			209
Projected Multiple Dry Year Demands (AFY)			201

TABLE 2-7
DEMAND FACTORS USED IN WATER SUPPLY ASSESSMENT CALCULATIONS^(a)

Land Use	Residential Indoor Demand (GPCD)	PPL/DU	Residential Outdoor Demand (Gal/Ac/Year)	Non-Residential Demand (Gal/TSF/Year)
Single Family (<1 du/ac)	50	3.74	1,260,050	
Single Family (1-5 du/ac)	50	3.57	1,260,050	
Single Family (6-10 du/ac)	50	3.74	1,260,050	
Accessory Dwelling Unit	50	1	0	
Condo/Townhome	50	3.62	2,520,100	
Apartment	50	2.46	2,520,100	
Mobile Home	50	2.37	2,520,100	
Senior Living Facility	50	1.87	2,520,100	
HOA/Dedicated Irrigation			1,023,100	
Developed Park			1,023,100	
Commercial				90,000
Industrial Park				20,000
Institutional				330,000

Notes:

(a) Demand factors derived from 2020 UWMP

Section 3: Existing and Projected Water Supplies

Water Code Section 10910(b) requires a WSA to identify any existing water supply entitlements, water rights, or water service contracts relevant to the identified water supply for the Project and describe the quantities of water received in prior years by the public water system. The identification of existing water supply entitlements, water rights, or water service contracts held by the public water system must be demonstrated by providing information related to the following:

1. Written contracts or other proof of entitlement to an identified water supply;
2. Copies of a capital outlay program for financing the delivery of a water supply that has been adopted by the public water system;
3. Federal, state, and local permits for construction of necessary infrastructure associated with delivering the water supply; and
4. Any necessary regulatory approvals that are required in order to be able to convey or deliver the water supply.

In accordance with SB 610 (Water Code Section 10910(d)), Section 2 of the 2020 UWMP (June 2020) and the 2019 Santa Clarita Valley Water Report summarize the total quantity of water used by SCV Water to meet water demand since importation of SWP water began in 1980. Also, Section 1.7, above, contains a list of documents with information related to the identification of the existing water supply entitlements, water rights, or water service contracts relevant to meet the Project's water demand, in addition to the existing and projected water supplies reported in the 2020 UWMP and the most recent 2019 and 2020 Santa Clarita Valley Water Reports.

SCV Water has existing water entitlements, rights, and contracts to meet demand as needed over a 25-year horizon and beyond and has committed sufficient capital resources and planned investments in various water programs and facilities to serve all its existing and planned customers. As discussed herein, SCV Water also has identified an operational strategy combined with a prudent and flexible management approach to ensure water supply reliability.

SCV Water's existing supplies include imported water, local groundwater, recycled water, and water from existing groundwater banking programs. Planned supplies include new groundwater production as well as additional banking programs. The mix of supplies can vary significantly depending on local and statewide hydrology, access to groundwater, and other factors. For example, in 2019, a wet year, imported water supplies made up 58%, groundwater 41%, and recycled water less than 1%. In 2020 dry hydrology and perchlorate and PFAS in local groundwater resulted in groundwater production making up approximately 26% of SCV Water's total supplies, imported water making up 39%, recycled water making up less than 1% of supplies, and existing banking and exchange programs making up approximately 34% of total supplies. A further description of the variability of the mix of supplies is included in Section 5.1 of this WSA.

3.1 Imported Water Supplies

SCV Water's imported water supplies consist primarily of SWP supplies, which were first delivered to SCV Water (CLWA at the time) in 1980. From the SWP, SCV Water also has access to water from Flexible

Storage Accounts in Castaic Lake, which are planned for dry-year use, but are not strictly limited as such. In addition to its SWP supplies, SCV Water has an imported supply from the Buena Vista Water Storage District (BVWSD) and Rosedale Rio-Bravo Water Storage District (RRBWSD) in Kern County, which was first delivered to SCV Water (CLWA at the time) in 2007. Additionally, Newhall Land and Farming Company (Newhall Land or NLF) (now also referred to as Five Point) has a water transfer supply from a source in Kern County, referred to as Nickel Water that for planning purposes is anticipated to be available beginning in 2035.

3.2 State Water Project Supplies

3.2.1 SWP Facilities

The SWP is the largest state-built, multi-purpose water project in the country. It was authorized by the California State Legislature in 1959, with the construction of most initial facilities completed by 1973. Today, the SWP includes 28 dams and reservoirs, 26 pumping and generating plants and approximately 660 miles of aqueducts. The primary water source for the SWP is the Feather River, a tributary of the Sacramento River. Storage released from Oroville Dam on the Feather River flows down natural river channels to the Sacramento-San Joaquin River Delta (Delta). While some SWP supplies are pumped from the northern Delta into the North Bay Aqueduct, the vast majority of SWP supplies are pumped from the southern Delta into the 444-mile-long California Aqueduct. The California Aqueduct conveys water along the west side of the San Joaquin Valley to Edmonston Pumping Plant, where water is pumped over the Tehachapi Mountains and the aqueduct then divides into the East and West Branches. SCV Water takes delivery of its SWP water at Castaic Lake, a terminal reservoir of the West Branch. From Castaic Lake, SCV Water delivers its SWP supplies to its customers through an extensive transmission pipeline system.

3.2.2 SWP Water Supply Contract Amendments

SWP Contract and Extension

The Department of Water Resources (DWR) provides water supply from the SWP to 29 SWP Contractors (Contractors) in exchange for Contractor payment of all costs associated with providing that supply. DWR and each of the Contractors entered into substantially uniform long-term water supply contracts (Contracts) in the 1960s with 75-year terms. The first Contract terminates in 2035, and most of the remaining Contracts terminate within three years after that. SCV Water is one of the 29 Contractors that have an SWP Contract with DWR.

The majority of the capital costs associated with the development and maintenance of the SWP is financed using revenue bonds. These bonds have historically been sold with 30-year terms. It has become more challenging in recent years to affordably finance capital expenditures for the SWP because bonds used to finance these expenditures are limited to terms that only extend to the year 2035, fewer than 15 years from now. To ensure continued affordability of debt service to Contractors, it was necessary to extend the termination date of the Contracts to allow DWR to continue to sell bonds with 30-year terms.

Public negotiations to extend the Contracts took place between DWR and the Contractors during 2013 and 2014. An Agreement in Principle (AIP) was reached and was the subject of analysis under the requirements of the CEQA (Notice of Preparation dated September 12, 2014). On December 11, 2018, the DWR Director approved the Water Supply Contract Extension Project. In accordance with CEQA, DWR also filed its Notice of Determination for the project with the Governor's Office of Planning and Research. In addition,

DWR filed an action in Sacramento County Superior Court to validate the Contract Extension Amendments (<https://Water.ca.gov/Programs/State-Water-Project/Management/Water-Supply-Contract-Extension>). After CEQA was completed and contract language was finalized, DWR and 22 contractors executed the Extension Amendment, including SCV Water, which executed the amendment in February 2019. The Extension Amendment extends the contracts through 2085 or the period ending with the latest maturity date of any bond issued to finance the construction costs of Project facilities, whichever is longer. The Extension Amendment will improve the project's overall financial integrity and management. The Extension Amendment is the subject of a validation action and two CEQA lawsuits.

Water Management Tools Contract Amendment

In a December 2017 Notice to Contractors, DWR indicated its desire to supplement and clarify existing SWP Contract's water transfer and exchange provisions to provide improved water management among public water agencies (PWAs). The purpose was to seek greater flexibility to manage the system in order to address changes in hydrology and further constraints placed on DWR's operation of the SWP. To this end, PWAs and DWR conducted public negotiations in 2017 with the purpose of improving these water management tools (WMT). Importantly, the transfers and exchanges provided for in a WMT Contract amendment are limited to those transfers and exchanges between PWAs with SWP Contracts.

In June 2018, PWAs and DWR agreed upon an Agreement in Principle (AIP), which included specific principles to accomplish this goal. These principles included a process for transparency for transfers and exchanges, new flexibility for single and multi-year non-permanent water transfers, allowing PWAs to set terms of compensation for transfers and exchanges, and providing for the limited transfer of carryover and Article 21 water.

In October 2018, a Draft Environmental Impact Report (DEIR) was circulated based on the agreed upon AIP principles for a WMT Contract amendments. At that time, the AIP included cost allocation for the California WaterFix project (WaterFix). In early 2019, Governor Newsom decided not to move forward with WaterFix, and DWR rescinded its approvals for WaterFix. After this shift, the PWAs and DWR held a public negotiation session and agreed to remove the WaterFix cost allocation sections from the AIP, but to keep all the water management provisions in the AIP. The AIP for water management provisions was finalized on May 20, 2019. In February 2020, DWR amended and recirculated the Partially Recirculated DEIR for the SWP Supply Contract Amendments for Water Management and in August 2020, DWR certified the Final EIR. The EIR is being challenged in court. The WMT Amendment became effective for those PWAs who executed the amendment on February 28, 2021. The transfer and exchange tools are available during litigation and will remain in effect unless there is a final court order that prohibits their continuation.

Delta Conveyance Project Agreement in Principle

On March 29, 2021, as part of a public negotiation that began in 2019, DWR and PWAs agreed upon an Agreement in Principle for a Contract amendment on a Delta Conveyance Project (DCP). The objective of the DCP AIP is to develop an agreement to equitably allocate costs and benefits among SWP PWAs of a potential Delta Conveyance Facility that preserves operational flexibility. A decision by each participating PWA for approving a contract amendment with DWR would not occur until after the environmental review for the DCP is completed. That decision would likely occur in 2023, at the earliest.

3.2.3 SWP Water Supplies

Each SWP contractor's SWP Contract contains a "Table A," which lists the maximum amount of contract water supply, or "Table A Water," an agency may request each year throughout the life of the contract.

3-3

The Table A Amounts in each contractor's SWP Contract ramped up over time, based on projections at the time the contracts were signed and future increases in population and water demand, until they reached a maximum Table A Amount. Most contractor's Table A Amounts reached their maximum levels in the early to mid-1990s. Table A Amounts are used in determining each contractor's proportionate share, or "allocation," of the total SWP Water supply DWR determines to be available each year.

The total planned annual delivery capability of the SWP and the sum of all contractors' maximum Table A Amounts was originally 4.23 million acre-feet (MAF). The initial SWP storage facilities were designed to meet contractors' water demands in the early years of the SWP, with the construction of additional storage facilities planned as demands increased. However, essentially no additional SWP storage facilities have been constructed since the early 1970s. SWP conveyance facilities were generally designed and have been constructed to deliver maximum Table A amounts to all contractors. After the permanent retirement of some Table A amount by two agricultural contractors in 1996, the maximum Table A Amounts of all SWP contractors now total about 4.17 MAF. Currently, SCV Water's annual Table A Amount is 95,200 AF,¹⁰

The primary supply of SWP water made available under the SWP Contracts is allocated Table A supply.

In addition to Table A supplies, the SWP Contracts provide for additional types of water that may periodically be available, including "Article 21" water and water made available through transfers from other SWP Contractors pursuant to the WMT amendment described above (amended Article 56). Article 21 water (which refers to the SWP Contract provision defining this supply) is water that may be made available by DWR when excess flows are available in the Delta (i.e., when Delta outflow requirements have been met, SWP storage south of the Delta is full and conveyance capacity is available beyond that being used for SWP operations and delivery of allocated and scheduled Table A supplies). Article 21 water is made available on an unscheduled and interruptible basis and is typically available only in average to wet years, generally only for a limited time in the late winter.

The availability of Article 21 water and water from transfers with other SWP Contractors can fluctuate significantly. When available, these supplies provide additional water that SCV Water may be able to use, either directly to meet demands or for later use after storage in its groundwater banking programs. Because of the fluctuations in availability of Article 21 water and water from transfers, supplies of these types of SWP water are not included in this WSA. However, to the extent SCV Water is able to make use of these supplies when available, SCV Water may be able to improve the reliability of its SWP supplies beyond the values used throughout the 2020 UWMP and this WSA.

While not specifically provided for in the SWP Contracts, DWR or the State Water Contractors have in dry years facilitated Dry Year Water Purchase Programs for contractors needing additional supplies. Through these programs, water is purchased from willing sellers in areas that have available supplies and is then sold to contractors willing to purchase those supplies. The availability of these supplies is annually variable and therefore they are not included in this WSA. However, SCV Water's access to these supplies when they are available would enable it to improve the reliability of its dry-year supplies beyond the values used throughout this WSA.

¹⁰ SCV Water's original SWP Contract with DWR was amended in 1966 for a maximum annual Table A Amount of 41,500 AF. In 1991, SCV Water (CLWA at the time) purchased 12,700 AF of annual Table A Amount from a Kern County Water district, and in 1999 purchased an additional 41,000 AF of annual Table A Amount from another Kern County Water district, for a current total annual Table A Amount of 95,200 AF.

Flexible Storage Account

As part of its SWP Contract with DWR, SCV Water has access to a portion of the storage capacity of Castaic Lake. This Flexible Storage Account allows SCV Water to utilize up to 4,684 AF of the storage in Castaic Lake for SCV Water. Any of this amount that SCV Water withdraws must be returned to storage by SCV Water within five years of its withdrawal. SCV Water manages this storage by keeping the account full in normal and wet years and then delivering that stored amount (or a portion of it) during dry periods. The account is refilled during the next year that adequate SWP supplies are available to SCV Water to do so. In 2005 and again in 2015, SCV Water negotiated with Ventura County SWP contractor agencies to obtain the use of their Flexible Storage Account. This allows SCV Water access to another 1,376 AF of storage in Castaic Lake. With the extension to the term of the agreement, SCV Water access to this additional storage is available on a year-to-year basis through 2025. While it is expected that SCV Water and Ventura County will extend the existing flexible storage agreement beyond the 2025 term, it is not assumed to be available beyond 2025 in the 2020 UWMP or this WSA.

Water Management Provisions

The SWP Contract includes a number of provisions that give each contractor flexibility in managing the supplies that are available to it in a given year. For example, a contractor may take delivery of its allocated SWP supplies for direct use or storage within its service area, store that water outside its service area for later withdrawal and use within its service area, carry over a portion of that supply for storage on an as-available-basis in SWP reservoirs for delivery in following years (commonly referred to as “carryover”), exchange a portion of that supply with others for return in a future year, or transfer water with other PWAs pursuant to the newly approved WMT amendment. The SWP Contract also provides for DWR to deliver non-SWP water supplies for contractors through SWP conveyance facilities.

SCV Water takes advantage of these water management provisions in wetter years by storing excess SWP allocated water supply, either in groundwater banking programs or as carryover, or by exchanging supplies with another contractor or water agency. Then in drier years, SCV Water withdraws its previously stored supplies or recovers water from its exchange partner(s). Water stored in groundwater banking programs has the benefit of remaining available until needed, and the water SCV Water currently has in storage is assumed to be available as described in the 2020 UWMP and incorporated herein. At current demand levels, SCV Water also regularly stores a portion of any excess supply as carryover in SWP reservoirs, which can provide it with additional supply for use in following years. Carryover is a no-added-cost storage option, is an easily and quickly accessible supply, and is a valuable benefit if the next year is dry. However, SCV Water carryover water may be lost when SWP reservoirs fill, which can occur in wetter years. Although the carryover water is considered in the 2021-2025 water drought assessment, because of the variability in how frequently SWP reservoir space would be available to store SCV Water’s carryover, it is not specifically included in other supply projections of the 2020 UWMP or this WSA.

3.2.4 Factors Affecting SWP Table A Supplies

While Table A identifies the maximum annual amount of Table A Water a SWP contractor may request, the amount of SWP water actually available and allocated to SWP contractors each year is dependent on a number of factors and can vary significantly from year to year. The primary factors affecting SWP supply availability include: the availability of water at the source of supply in northern California, the ability to transport that water from the source to the primary SWP diversion point in the southern Delta, and the magnitude of total contractor demand for that water.

Availability of SWP Source Water

SWP supplies originate in northern California, primarily from the Feather River Watershed. The availability of these supplies is dependent on the amount of precipitation in the Watershed, the amount of that precipitation that runs off into the Feather River, water use by others in the Watershed, and the amount of water in storage in the SWP's Lake Oroville at the beginning of the year. Variability in the location, timing, amount, and form (rain or snow) of precipitation, as well as how wet or dry the previous year was, produces variability from year to year in the amount of water that flows into Lake Oroville. However, Lake Oroville acts to regulate some of that variability, storing high inflows in wetter years that can be used to supplement supplies in dry years with lower inflows.

In DWR's 2019 State Water Project Delivery Capability Report (2019 DCR), climate change adds another factor in estimating the future availability of SWP source water. Current projections indicate that global warming may change precipitation patterns in California from the patterns that have occurred historically. While different climate change models show differing effects, potential changes are anticipated to include more precipitation falling in the form of rain rather than snow and earlier snowmelt, which would result in more runoff occurring in the winter and early spring rather than spread out over the winter and spring, creating challenges in capturing this runoff for later use in the SWP delivery system.

Ability to Convey SWP Source Water

As discussed previously, water released from Lake Oroville flows down natural river channels into the Delta. The Delta is a network of channels and reclaimed islands at the confluence of the Sacramento and San Joaquin rivers. The SWP and the federal CVP use Delta channels to convey water to the southern Delta for diversion, making the Delta a focal point for water distribution throughout the state.

A number of issues affecting the Delta can impact the ability to divert water supplies from the Delta, including water quality, fishery protection and levee system integrity. Water quality in the Delta can be adversely affected by both SWP and CVP diversions, which primarily affect salinity, as well as by urban discharge and agricultural runoff that flows into the Delta, which can increase concentrations of constituents such as mercury, organic carbon, selenium, pesticides, toxic pollutants and reduce dissolved oxygen. The Delta also provides a unique estuarine habitat for many resident and migratory fish species, some of which are listed as threatened or endangered. The decline in some fish populations is likely the result of a number of factors, including water diversions, habitat destruction, degraded water quality, and the introduction of non-native species. Delta islands are protected from flooding by an extensive levee system. Levee failure and subsequent island flooding can lead to increased salinity requiring the temporary shutdown of SWP pumps. In addition, climate change analyses also project that salinity issues will increase with sea level rise, requiring extra Delta outflow to dilute more brackish Delta water to meet environmental standards.

In order to address some of these issues, SWP and CVP operations in the Delta are limited by a number of regulatory and operational constraints. These constraints are primarily incorporated into the SWRCB Water Rights Decision 1641 (D-1641), which establishes Delta water quality standards and outflow requirements with which the SWP and CVP must comply. In addition, SWP and CVP operations are further constrained by requirements included in Biological Opinions (BOs) for the protection of threatened and endangered fish species in the Delta issued by the FWS in December 2008 and the NMFS in June 2009, and most recently in 2019 by the FWS as described in Section 4.2. The requirements in the BOs are based

on real-time physical and biological phenomena (such as turbidity, water temperature, and location of fish), which results in uncertainty in estimating potential impacts on supply of the additional constraints imposed by the BOs.

Demand for SWP Water

The reliability of SWP supplies is affected by the total amount of water requested and used by SWP contractors, since an increase in total requests increases the competition for limited SWP supplies. As previously mentioned, contractor Table A Amounts in the SWP Contracts ramped up over time, based on projected increases in population and water demand at the time the contracts were signed. Urban SWP contractors' requests for SWP water were low in the early years of the SWP, but have increased steadily over time, although more slowly than the initial ramp-up in their Table A Amounts, which reached a maximum for most contractors in the early to mid-1990s. Since that time, urban contractors' requests for SWP water have continued to increase until recent years when nearly all SWP contractors are requesting their maximum Table A Amounts.

Consistent with other urban SWP contractors, SWP deliveries to SCV Water have increased as its requests for SWP water have increased. Historical total SWP deliveries to SCV Water are shown in Section 3. The table shows deliveries to the SCV Water service area for supply to the purveyors, as well as delivery of SCV Water supplies to storage programs outside the service area and to exchange partners. SCV Water demand projections provided to DWR are typically conservative in order to maximize water deliveries available to SCV Water in any given year for both deliveries and to current and future storage programs.

3.2.5 Biological Opinion

In late 2019, the FWS and NMFS issued new Biological Opinions (BOs) for the Long-Term Operation of the CVP and SWP. Consultation on the BOs began in 2016 to update the prior 2008 and 2009 BO and provide Federal Endangered Species Act (ESA) compliance for the CVP and SWP. Additionally, in early 2020, the California Department of Fish and Wildlife (DFW) issued DWR an Incidental Take Permit for the Long-Term Operation of the SWP pursuant to the California Endangered Species Act (CESA) with regards to state-protected longfin smelt and state- and federally protected delta smelt, winter-run Chinook and spring-run Chinook. Previously, DFW had issued the SWP an Incidental Take Permit for the state-listed longfin smelt and Consistency Determinations with the 2008 and 2009 Biological Opinions for the state and federally listed species, not a separate permit. Some of the operational restrictions in the 2019 Biological Opinions differ from those in the 2020 Incidental Take Permit. Specifically, even though the projects' operations are coordinated, the SWP is subject to additional operational constraints that reduce SWP supplies and create operational conflicts. Both the 2019 BOs and the 2020 Incidental Take Permit are subject to multiple court challenges that are ongoing.

Biological Opinion Litigation. Two cases were filed challenging the BOs under the ESA, Administrative Procedure Act, and National Environmental Policy Act (NEPA). The first case, *Pacific Coast Federation of Fisherman's Association, et al. v. Ross* (Case No. 1:20-CV-00431-DAD-SAB ("*PCFFA v. Ross*")), was brought by six environmental organizations. The second case, *California Natural Resources Agency, et al. v. Ross* (Case No. 1:20) ("*CNRA v. Ross*"), was brought by the California Natural Resources Agency (CNRA), the California Environmental Protection Agency, and the California Attorney General. The State's case includes a cause of action under CESA alleging that the federal CVP must comply with CESA. The cases were coordinated and transferred to the Eastern District. State and federal water contractors have intervened as defendants in both cases. On October 1, 2021, the federal agencies announced re-initiation

of consultation on the BOs. The court is currently considering motions by the Federal defendants, State plaintiffs, and environmental plaintiffs to impose an interim operations plan for the first year of reinitiated consultation.

CESA Incidental Take Permit Litigation. Eight cases, listed below, have been filed in state court by public agencies, environmental organizations, and a Native American tribe challenging DWR's approval of the Long-Term Operations of the SWP and associated environmental review. Most of the cases also challenge CDFW's issuance of an Incidental Take Permit for the SWP.

North Coast Rivers Alliance, et al. v. Department of Water Resources, et al., County of San Francisco Superior Court Case No. CPF-20-517078, filed April 28, 2020;

State Water Contractors, et al. v. California Department of Water Resources, et al., County of Fresno Superior Court Case No. 20CECG01302, electronically filed April 28, 2020;

Tehama-Colusa Canal Authority, et al. v. California Department of Water Resources, et al., County of Fresno Superior Court Case No. 20CECG01303, electronically filed April 28, 2020;

The Metropolitan Water District of Southern California, et al. v. California Department of Water Resources, et al., County of Fresno Superior Court Case No. 20CECG01347, electronically filed April 28, 2020;

Sierra Club, et al. v. California Department of Water Resources, County of San Francisco Superior Court Case No. CPF-20-517120, filed April 29, 2020;

Central Delta Water Agency, et al. v. California Department of Fish and Wildlife, et al., County of Sacramento Superior Court Case No. 34-2020-80003368, filed May 6, 2020;

San Bernardino Valley Municipal Water District v. California Department of Water Resources, et al., County of Fresno Superior Court Case No. 20CECG01556, filed May 28, 2020;

San Francisco Baykeeper, et al. v. California Department of Water Resources, et al., County of Alameda Superior Court Case No. RG20063682, filed June 5, 2020.

The challenges are raised on several legal grounds, including CESA, California Environmental Quality Act, the Delta Reform Act, Public Trust Doctrine, area of origin statutes, breach of contract, and breach of covenant of good faith and fair dealing. All eight cases have been coordinated in Sacramento County Superior Court.

Litigation over the 2019 BOs and 2020 Incidental Take Permit will likely take several years. The projects began operating in accordance with the new requirements in 2020. Throughout implementation, any party may seek preliminary injunctive relief during the litigation, such as that described above. It is likely that the 2019 BOs and 2020 Incidental Take Permit, or some form of interim operations, will govern operations until final judicial determinations on the merits are made or the reinitiated consultation results in a new Biological Opinion and amended Incidental Take Permit. Thus, it is unlikely that SWP water supply would increase beyond that resulting from the limitations in the 2019 BOs and 2020 Incidental Take Permit during this timeframe.

3.2.6 SWP Table A Supply Assessment

DWR prepares a biennial report to assist SWP contractors and local planners in assessing the availability of supplies from the SWP. DWR issued its most recent update, the 2019 DCR, in August 2020. In this update, DWR provides SWP supply estimates for SWP Contractors to use in their planning efforts, including for use in their 2020 UWMPs. The 2019 DCR includes DWR's estimates of SWP water supply availability under both existing (2020) and future conditions (2040).

DWR's estimates of SWP deliveries are based on a computer model that simulates monthly operations of the SWP and Central Valley Project systems. Key inputs to the model include the facilities included in the system, hydrologic inflows to the system, regulatory and operational constraints on system operations, and contractor demands for SWP water. In conducting its model studies, DWR must make assumptions regarding each of these key inputs.

In the 2019 DCR for its model study under existing conditions, DWR assumed: existing facilities, hydrologic inflows to the model based on 82 years of historical inflows (1922 through 2003), current regulatory and operational constraints including 2018 Coordinated Operation Agreement Amendment, 2019 BOs and 2020 Incidental Take Permit, and contractor demands at maximum Table A Amounts. The long-term average allocation reported in the 2019 DCR for the existing conditions study provides an appropriate estimate of the SWP water supply availability under current conditions.

To evaluate SWP supply availability under future conditions, the 2019 DCR included a model study representing hydrologic and sea level rise conditions in the year 2040. The future condition study used all the same model assumptions as the study under existing conditions, but reflected changes expected to occur from climate change, specifically, projected temperature and precipitation changes centered around 2035 (2020 to 2049) and a 45 cm sea level rise. For the long-term planning purposes of this WSA and the 2020 UWMP, the long-term average allocations reported for the future conditions study from 2019 DCR is the most appropriate estimate of future SWP water supply availability.

3.2.7 SWP Water Supply Estimates

In the 2019 DCR, DWR estimates that for all Contractors combined, the SWP can deliver on a long-term average basis a total Table A supply of 58 percent of total maximum Table A Amounts under existing conditions and 52 percent under future conditions.

DWR's 2019 DCR indicates that the modeled single dry year SWP water supply allocation is 7% under the existing conditions. However, historically the lowest SWP allocations were at 5% in 2014 and initial allocations in 2021. Due to extraordinarily dry conditions in 2013 and 2014, the initial 2014 SWP allocation was a historically low 5% of Table A Amounts, was later reduced to 0% in January 2014, and was later raised back to 5%, the lowest ever final total SWP water supply allocation. In 2021, the initial allocation was 0%, the lowest ever on record and later increased to 5%. Similarly, the initial allocation for 2022 was set at 0% with DWR prioritizing deliveries to Human Health and Safety where alternative supplies were not available. Significant precipitation occurred in October and December of 2021. In January 2022, DWR raised its initial allocation to 15%.

Each year by October 1, SWP contractors submit their requests for SWP supplies for the following calendar year. By December 1, DWR estimates the available water supply for the following year and sets an initial supply allocation based on the total of all contractors' requests, current reservoir storage, forecasted hydrology through the next year, and target reservoir storage for the end of the next year. The most difficult of these factors to evaluate is the forecasted hydrology. In setting water supply allocations, DWR uses a

conservative 90% hydrologic forecast, where nine out of ten years will be wetter and one out of ten years drier than assumed. DWR re-evaluates its estimate of available supplies throughout the runoff season of winter and early spring, using updated reservoir storage and hydrologic forecasts, and revises SWP supply allocations as warranted. Since most of California's annual precipitation falls in the winter and early spring, by the end of spring the supply available for the year is much more certain, and in most years DWR issues its final SWP allocation by this time. While most of the water supply is certain by this time, runoff in the late fall remains somewhat variable as the next year's runoff season begins. A drier than forecasted fall can result in not meeting end-of-year reservoir storage targets, which means less water available in storage for the following year.

Water year 2013 was a year with two hydrologic extremes. October through December 2012 was one of the wettest fall periods on record but was followed by the driest consecutive 12 months on record. The supply allocation for 2013 was a 35% allocation. However, the 2013 hydrology ended up being even drier than DWR's conservative hydrologic forecast, so the SWP began 2014 with reservoir storage lower than targeted levels and less stored water available for 2014 supplies. Compounding this low storage situation, 2014 also was a critically dry year, with runoff for water year 2014 the fourth driest on record.

The exceedingly dry sequence from the beginning of January 2013 through the end of 2014 was one of the driest two-year periods in the historical record. The dry-year sequence in 2020 through 2021 also represents an extreme hydrologic event in terms of temperature and precipitation. Water Year 2020 was California's fifth driest year on record based on statewide runoff, followed by Water Year 2021 which was the second driest year and warmest year on record. The warmer temperatures in 2014 and 2021 resulted in an increased climatic water deficit. This historical data has shown that California's climate is transitioning to a much warmer setting where historical relationships among temperature, precipitation and runoff are changing, and these conditions may become more frequent. As noted above, the circumstances that led to the low 2014 and 2021 SWP water supply allocation were unusual, and likely have a low probability of frequent occurrence in the future. Thus, the assumption for SWP contractors such as SCV Water is that a 5% allocation in 2014 and 2021 represents the "worst-case" scenario.

The 2020 UWMP reflected information from DWR's 2019 DCR. The report was based on DWR's CALSIM 2 model that utilizes a repeat of the historic hydrologic period of 1922 through 2003. DWR's analysis of existing (2020) conditions was used to estimate SWP supplies between 2020 and 2040 and its analysis of future (2040) conditions is used to estimate 2040-2050 SWP supplies. SWP supplies for the five-year increments between 2020 and 2040 are interpolated between these values. SWP supplies for years beyond 2040 are assumed to be the same as for 2040.

On December 31, 2021, DWR released its Draft 2021 DCR. This draft report is based on DWR's new CALSIM 3 model that extends the hydrologic period through 2015 thus incorporating the historic dry years of 2014 and 2015 but does not include the wet years in 2017 and 2019. This report reduces the 2020 average yield from 58% to 56%. The Draft 2021 DCR does not contain an analysis for 2040 conditions as it was not contained in the 2019 DCR. Thus, the SWP reliability shown in Table 3-1 reflects reduced reliability of 56% in 2020 and other year's supplies are interpolated between 2020 and 2040 values.

The Draft 2021 DCR also reduced the single year delivery capability in 2020 to 5%. As the 2020 UWMP was already using that value for its Single Years SWP supply, that value was not changed in the single year dry period. This is reflected in Table 3-1.

The Draft 2021 DCR did not provide Table A allocations for each individual year that would enable a re-analysis of the five-year multiple dry year period. The report does contain a summary of six-year drought that indicate an average allocation of 25% of Table A amounts. That is the same average value that was

used in the 2020 UWMP. Thus, for purposes of this WSA, Table 3-1 reflects the same five-year multiple dry year analysis

TABLE 3-1
SWP TABLE A SUPPLY RELIABILITY (AF)^{(a)(b)}

Wholesaler (Supply Source)	2020	2025	2030	2035	2040-2050
Average Water Year^(c)					
SWP Table A Supply	53,312	52,360	51,408	50,456	49,504
% Of Table A Amount ^(d)	56%	55%	54%	53%	52%
Single-Dry Year					
SWP Table A Supply ^(e)	6,664	7,616	8,568	9,520	10,472
% Of Table A Amount ^(e)	7%	8%	9%	10%	11%
SWP Table A Supply ^(f)	4,760	4,760	4,760	4,760	4,760
% Of Table A Amount ^(f)	5%	5%	5%	5%	5%
Multiple-Dry Year^(h)					
SWP Table A Supply ^(g)	23,800	23,800	23,800	23,800	23,800
% Of Table A Amount ^(d)	25%	25%	25%	25%	25%

Notes:

- (a) Supplies to SCV Water are based on DWR analyses presented in its 2021 draft DCR and 2019 DCR, assuming existing SWP facilities and current regulatory and operational constraints (except as indicated in Note f).
- (b) Table A supplies include supplies allocated in one year that are carried over for delivery the following year.
- (c) Based on average deliveries over a repeat of the study's historic hydrologic period of 1922 through 2003 for 2019 DCR, and 1922 through 2015 for the 2021 draft DCR.
- (d) Supply as a percentage of SCV Water's Table A Amount of 95,200 AF.
- (e) Based on a repeat of the worst case historic single dry year of 1977 (from 2019 DCR)
- (f) Based on the worst-case actual allocation of 2014.
- (g) Supplies shown are annual averages over five consecutive dry years, based on a repeat of the historic five-year dry period of 1988-1992.

3.2.8 Coordinated Operations Agreement

The Coordinated Operation Agreement (COA) was originally signed in 1986 and defines how the state and federal water projects share the available water supply and the obligations including senior water right demands, water quality and environmental flow requirements imposed by regulatory agencies. The agreement calls for periodic review to determine whether updates are needed in light of changed conditions. After completing a joint review process, DWR and the Bureau of Reclamation agreed to an addendum to the COA in December 2018, to reflect water quality regulations, biological opinions and hydrology updated since the agreement was signed.

The COA Addendum includes changes to the percentages for sharing responsibilities for in basin uses, sharing available export capacity, and the review process. The 1986 Agreement required CVP to meet 75% of the in basin uses and the SWP to meet 25%. The COA Addendum now distinguishes responsibility based on water year type and CVP responsibilities range from 80% in wet years to 60% in critical years. SWP responsibility ranges from 20% in wet years to 40% in critical years. Additionally, the COA Addendum changed sharing export capacity. Previously, export capacity was shared 50% to CVP and 50% to SWP. The COA addendum changed this formula to be 65% CVP and 35% SWP during balanced conditions and 60% CVP and 40 % SWP during excess conditions. Overall, based on modeling, these changes result in an approximately 115,000 AFY on average reduction in SWP supplies.

Finally, the 2018 COA Addendum updated the review process to require review of the COA Agreement and Addendum every 5 years. Litigation regarding the COA addendum environmental review is ongoing. The litigation is unlikely to change the negotiated COA addendum and implementation has already begun.

3.2.9 Delta Conveyance Project

Consistent with Executive Order N-10-19, in early 2019, the state announced a new single tunnel project, which proposed a set of new diversion intakes along Sacramento River in the north Delta for the SWP. In 2019, DWR initiated planning and environmental review for a single tunnel DCP to protect the reliability of SWP supplies from the effects of climate change and seismic events, among other risks. DWR's current schedule for the DCP environmental planning and permitting extends through the end of 2024. DCP will potentially be operational in 2040 following extensive planning, permitting and construction.

DWR estimates of SWP supply reliability in its 2019 DCR are based on existing facilities, and so do not include the proposed conveyance facilities that are part of the DCP. Since the 2020 UWMP uses DWR's 2019 DCR to estimate SWP supplies at 2040, any changes in SWP supply reliability that would result from the proposed DCP are not included in the UWMP. If the DCP is implemented, SWP reliability would improve, but to be conservative, that analysis is not incorporated in this WSA.

3.2.10 Emergency Freshwater Pathway Description (Sacramento-San Joaquin Delta)

It has been estimated by DWR that in the event of a major earthquake in or near the Delta, water supplies could be interrupted for up to three years, posing a significant and unacceptable risk to the California business economy. A post-event strategy would provide necessary water supply protections to avert this catastrophe. Such a plan has been coordinated through DWR, Corps of Engineers (Corps), Reclamation, California Office of Emergency Services (Cal OES), the Metropolitan Water District of Southern California, and the State Water Contractors.

DWR Delta Flood Emergency Management Plan: The Delta Flood Emergency Management Plan (DWR, 2018) provides strategies for response to Delta levee failures, up to and including earthquake-induced multiple island failures during dry conditions when the volume of flooded islands and saltwater intrusion are large, resulting in curtailment of export operations. Under these severe conditions, the plan includes a strategy to establish an emergency freshwater pathway from the central Delta along Middle River and Victoria Canal to the export pumps in the south Delta. The plan includes the repositioning of emergency construction materials at existing and new stockpile and warehouse sites in the Delta, and development of tactical modeling tools (DWR Emergency Response Tool) to predict levee repair logistics, timelines of levee repair and suitable water quality to restore exports. The Delta Flood Emergency Management Plan has been extensively coordinated with state, federal and local emergency response agencies. DWR, in conjunction with local agencies, the Corps and Cal OES, conduct tabletop and field exercises to test and revise the plan under real time conditions.

DWR and the Corps provide vital Delta region response to flood and earthquake emergencies, complementary to Cal OES operations. These agencies perform under a unified command structure and response and recovery framework. The Northern California Catastrophic Flood Response Plan (Cal OES, 2018) incorporates the DWR Delta Flood Emergency Management Plan. The Delta Emergency Operations Integration Plan (DWR and USACE, 2019) integrates personnel and resources during emergency operations.

Pathway Implementation Timeline: The Delta Flood Emergency Management Plan has found that using pre-positioned stockpiles of rock, sheet pile and other materials, multiple earthquake-generated levee breaches and levee slumping along the freshwater pathway can be repaired in less than six months. A supplemental report (Levee Repair, Channel Barrier, and Transfer Facility Concept Analyses to Support Emergency Preparedness Planning, M&N, August 2007) evaluated among other options, the placement of sheet pile to close levee breaches, as a redundant method if availability of rock is limited by possible competing uses. The stockpiling of sheet pile is vital should more extreme emergencies warrant parallel and multiple repair techniques for deep levee breaches. Stockpiles of sheet pile and rock to repair deep breaches and an array of levee slumping restoration materials are stored at DWR and Corps stockpile sites and warehouses in the Delta.

Emergency Stockpile Sites and Materials: DWR has acquired lands at Rio Vista and Stockton as major emergency stockpile sites, which are located and designed for rapid response to levee emergencies. The sites provide large loading facilities, open storage areas and new and existing warehousing for emergency flood fight materials, which augment existing warehousing facilities throughout the Delta. The Corps maintains large warehousing facilities in the Delta to store materials for levee freeboard restoration, which can be augmented upon request of other stockpiles in the United States. Pre-positioned rock and sheet pile are used for closure of deep levee breaches. Warehoused materials for rapid restoration of slumped levees include muscle (k-rail) walls, super sacks, caged rock containers, sandbags, stakes, and plastic tarp. Stockpiles will be augmented as materials are used.

Emergency Response Drills: Earthquake-initiated multiple island failures will mobilize DWR and Corps resources to perform Delta region flood fight activities within an overall Cal OES framework. In these events, DWR and the Corps integrate personnel and resources to execute flood fight plans through the Delta Emergency Operations Integration Plan (DWR and USACE, 2019). DWR, the Corps and local agencies perform emergency exercises focusing on communication readiness and the testing of mobile apps for information collection and dissemination. The exercises train personnel and test the readiness of emergency preparedness and response capabilities under unified command and provide information to help to revise and improve plans.

Levee Improvements and Prioritization: The DWR Delta Levees Subventions and Special Projects Programs have prioritized, funded, and implemented levee improvements along the emergency freshwater pathway and other water supply corridors in the central and south Delta. These efforts are complementary to the Delta Flood Emergency Management Plan, which along with pre-positioned emergency flood fight materials, ensures reasonable seismic performance of levees and timely pathway restoration after a severe earthquake. These programs have been successful in implementing a coordinated strategy of emergency preparedness to the benefit of SWP and CVP export systems.

Significant improvements to the central and south Delta levees systems along Old and Middle Rivers began in 2010 and are continuing to the present time. This complements substantially improved levees at Mandeville and McDonald Islands and portions of Victoria and Union Islands. Levee improvements along the Middle River emergency freshwater pathway and Old River consist of crest raising, crest widening, landside slope fill and toe berms, which improve seismic stability, reduce levee slumping, and create a more robust flood-fighting platform. Urban agencies, including Metropolitan, Contra Costa Water District, East Bay Municipal Utility District, and others have participated in levee improvement projects along or near the Old and Middle River corridors.

3.2.11 Sisk Dam Raise and San Luis Reservoir Expansion

Reclamation and San Luis & Delta Mendota Water Authority (SLDMWA) are proposing to raise Sisk Dam and increase storage capacity in San Luis Reservoir. The proposed 10-foot dam raise is in addition to the ongoing 12-foot raise of Sisk Dam to improve dam safety and would expand San Luis Reservoir storage by 130 thousand AF. The final supplemental EIS/EIR, released on December 18, 2020, estimated that the SWP exports could potentially reduce by about 23 thousand AFY on average under the preferred alternative. This project is currently undergoing design, environmental planning, and permitting. Construction is estimated to be completed by 2030, following environmental planning and permitting.

DWR estimates of SWP supply reliability in its 2019 DCR are based on existing facilities, and do not include this project.

3.2.12 SWP Seismic Improvements

DWR's recent SWP seismic resiliency efforts have focused heavily on SWP Dam Safety. The most prominent is the joint Reclamation/DWR corrective action study of Sisk Dam which will result in a massive seismic stability alteration project and is expected to begin construction in 2021. Several analyses have been conducted on SWP dam outlet towers/access bridges which has resulted in seismic upgrades (some completed/some on-going). Castaic Reservoir outlet towers were determined to be vulnerable to a major earthquake. DWR is currently undertaking retrofits to the access bridge to the Castaic outlet tower. That work is scheduled to be completed in 2022. Updated dam seismic safety evaluations are being performed on the Oroville Dam embankment and the radial gate control structure on the flood control spillway.

Seismic retrofits have also been completed on 23 SWP bridges located in four Field Divisions with additional retrofits in various development stages. DWR has also updated the earthquake notification procedures and has replaced and expanded instrumentation for the SWP's seismic network.

3.2.13 Water Quality Control Plan/Voluntary Agreement

The State Water Board is responsible for adopting and updating the Water Quality Control Plan for the San Francisco Bay/Sacramento-San Joaquin Delta Estuary (Bay-Delta Plan), which establishes water quality control objectives and flow requirements needed to provide reasonable protection of beneficial uses in the Watershed. The State Water Board has been engaged for many years in updating the Bay Delta Plan.

The Bay-Delta Plan is being updated through phases. Phase 1 is updating the Bay-Delta Plan objectives for the San Joaquin River and its major tributaries and the southern Delta salinity objectives. Phase 2 is updating the objectives for the Sacramento River and Delta and their major tributaries. (Plan amendments). On December 12, 2018, through State Water Board Resolution No. 2018-0059, the State Water Board adopted the Phase 1 Plan amendments and Final Substitute Environmental Document (SED) establishing the Lower San Joaquin River flow objectives and revised southern Delta salinity objectives. On February 25, 2019, the Office of Administrative Law approved the Plan amendments. The 2020 UWMP requires an adaptive range of 30-50 percent of the unimpaired flow to be maintained from February through June in the Stanislaus, Tuolumne, and Merced Rivers, with a starting point of 40 percent of the unimpaired flow. During this same time period, the flows at Vernalis on the San Joaquin River, as provided by the unimpaired flow objective, are required to be no lower than a base flow of 1,000 cubic feet per second (cfs), with an adaptive range between 800 and 1,200 cfs, inclusive. Phase 1 plan amendments are the subject of litigation.

The State Water Board is also considering Phase 2 Plan amendments focused on the Sacramento River and its tributaries, Delta eastside tributaries (including the Calaveras, Cosumnes, and Mokelumne rivers), Delta outflows, and interior Delta flows. Staff is recommending an adaptive range of 45-65 percent Unimpaired Flow (UIF) objective with a starting point of 55 percent. Once the State Water Board adopts Phase 2 Plan amendments, the Board will need to conduct hearings to determine, consistent with water rights, water users' responsibilities for meeting the objectives in both Phase 1 and 2. At this time, the potential impacts to the SWP are unknown, but this objective would have a large impact on water users in the Phase 2 planning area.

The State and several water users began working on an alternative to the Bay-Delta Plan update in 2018, known as the Voluntary Agreement process. The Voluntary Agreement process offers an alternative to the State Water Board staff's flow only approach. A Voluntary Agreement, if agreed to by the State Water Board, would be a substitute for the UIF approach and would become the Program of Implementation for the Plan amendments. Implementing the Voluntary Agreement would not require a water rights hearing because the parties are agreeing to take the actions. The Voluntary Agreement approach would provide flow, and funding for flows, habitat actions, and a robust science program. The Voluntary Agreement approach could provide an opportunity to combine flow and habitat actions to protect public trust resources, while providing certainty for water users. If successful, it provides a pathway to avoid years of hearings and litigation.

3.2.14 Delta Reliance

Approximately half of SCV Water's water supply comes from the Delta. The 2020 UWMP Guidebook describes how urban water suppliers that anticipate participating in or receiving water from a "covered action" related to the Delta should provide information in their 2020 UWMPs to demonstrate consistency with *Delta Plan Policy WR P1, Reduce Reliance on the Delta Through Improved Regional Water Self-Reliance* (Reduced Reliance Policy). SCV Water completed such documentation which is included in Appendix K of the 2020 UWMP.

3.2.15 Other Imported Supplies

The following supplies are available to SCV Water through agreements that have been executed since 2005. These supplies are now part of the imported supplies available to the service area.

3.2.15.1 Buena Vista-Rosedale Rio Bravo

SCV Water has executed a long-term transfer agreement for 11,000 AFY with BVWSD and RRBWSD. These two districts, both located in Kern County, joined together to develop a program that provides both a firm water supply and a water banking component. Both districts are member agencies of the Kern County Water Agency (KCWA), a SWP contractor, and both districts have contracts with KCWA for SWP Table A Amounts. The supply is based on existing long-standing Kern River water rights held by BVWSD and is delivered by exchange of the two districts' SWP Table A supplies or directly to the California Aqueduct via the Cross Valley Canal. This water supply is firm; that is, the total amount of 11,000 AFY is available in all water year types based on the Kern River Water right. SCV Water began taking delivery of this supply in 2007.

SCV Water has entered into agreements that reserved 3,378 AF of the Buena Vista-Rosedale Rio Bravo water for potential annexations into its service area. 389 AF is reserved for the second phase of the Tesoro

Del Valle development. This development is scheduled to be completed by the end of 2025. 489 AF has been reserved for the Tapia Ranch development with development estimated to be completed in the late 2020s. 2,500 AF is reserved for the planned Legacy Village development. This development is assumed to occur after 2030 but before 2035. During the periods before demands for these developments occur, or if these developments occur but do not use all the amounts reserved for them in any year or years, the remaining supply would be available to the entire SCV Water service area.

3.2.15.2 Nickel Water – Newhall Land

Newhall Land has acquired a water supply from Kern County sources known as the Nickel water. This source of supply totals 1,607 AFY. As provided in its water purchase agreement, the Nickel water provides a firm source of supply and is available in all hydrologic water year types. This source of supply was acquired in anticipation of the development of the Newhall Ranch Specific Plan Development. Newhall Land currently stores its annual supply of Nickel water in its Semitropic Water Storage District Water Banking Program. Upon completion of the Newhall Ranch Specific Plan, Newhall Land will transfer its rights to this supply to SCV Water. In the 2020 UWMP, it is assumed for planning purposes that Newhall Ranch will be developed and that this water supply will be transferred to SCV Water in 2035 (i.e., the assumed completion of the Newhall Ranch Specific Plan), thereafter becoming available as an annual supply to SCV Water. Prior to any permanent transfer to SCV Water, Newhall Land may make this supply available to SCV Water for purchase. However, because there is no history of such purchases, the 2020 UWMP, and this WSA, does not assume this Nickel water will be generally available to meet SCV Water demands until 2035. Further, SCV Water is not aware of any agreement that Newhall Land has entered into to sell this water to other public water systems prior to the transfer of the Nickel water to SCV Water.

SCV Water and NLF will monitor the use and storage of Nickel water. SCV Water is required to undertake this effort to manage its overall supply portfolio, to meet SCV Water’s obligations under applicable state law, and by request of the County of Los Angeles in the Specific Plan EIR. Based on current estimates, the Nickel water and the stored water in the Semitropic bank provide adequate reserves for potential future needs within the Specific Plan area. Under the Specific Plan EIR, NLF is to transfer Nickel water from its Semitropic Water Bank to make up a shortfall.

3.2.15.3 Yuba Accord Water

In 2008, SCV Water entered into the Yuba Accord Agreement, which allows for the purchase of water from the Yuba County Water Agency through DWR to 21 SWP contractors (including SCV Water) and the San Luis and Delta-Mendota Water Authority. Yuba Accord water comes from north of the Delta, and the water purchased under this agreement is subject to losses associated with transporting it through the Delta. These losses can vary from year to year, depending on Delta conditions at the time the water is transported. Under the agreement, an estimated average of up to 1,000 AFY of non-SWP supply (after losses) is available to SCV Water in dry years, through 2025. In 2021, with a SWP allocation of 5% of Table A Amount, a supply of 1,640 AF north of the Delta is available to SCV Water (based on September 27, 2021, estimate). Under certain hydrologic conditions, additional water may be available to SCV Water from this program. SCV Water received 284 AF from this source in 2020.

3.3 Groundwater

This section presents information about groundwater supplies, including a summary of the previously adopted groundwater management plan (GWMP) along with the recently adopted GSP.

3.3.1 Santa Clara River Groundwater Basin – East Subbasin

The sole source of local groundwater for urban water supply in the Valley is the groundwater Basin identified in the DWR Bulletin 118 (DWR 2016) as the Santa Clara River Valley Groundwater Basin, East Subbasin (Basin) (Basin No. 4-4.07). The un-adjudicated Basin is comprised of two aquifer systems, the Alluvium and the Saugus Formation. The Alluvium generally underlies the Santa Clara River and adjacent areas, including its several tributaries, to maximum depths of about 200 feet; and the Saugus Formation underlies practically the entire Upper Santa Clara River (USCR) area, to depths of at least 2,000 feet. There are also some scattered outcrops of Terrace deposits in the Basin that likely contain limited amounts of groundwater. However, since these deposits are located in limited areas situated at elevations above the regional water table and are also of limited thickness, they are of no practical significance as aquifers for municipal water supply; consequently, they have not been developed for any significant water supply in the Basin and are not included as part of the existing or planned groundwater supplies described in this WSA. The Basin is defined in Bulletin 118 as being bordered on the north by the Piru Mountains, on the west by impervious rocks of the Modelo and Saugus Formations and a constriction in the alluvium, on the south by the Santa Susana Mountains, and on the south and east by the San Gabriel Mountains (DWR 2016). The extent of the basin generally coincides with the outer extent of the Alluvium and Saugus Formation.

The Santa Clara River Valley Groundwater Basin, East Subbasin has been identified by DWR as a high priority basin, not subject to critical conditions of overdraft, thereby requiring preparation of a GSP, described below.

3.3.2 Groundwater Management Planning

As part of legislation authorizing SCV Water to provide retail water service to individual municipal customers, Assembly Bill (AB) 134 (2001) included a requirement that SCV Water prepare a GWMP (provided as Appendix I of the 2020 UWMP) in accordance with the provisions of Water Code Section 10753, which was originally enacted by AB 3030. This legislation has since been superseded by the passage of SGMA in 2014 and the submittal of a GSP to DWR by the SCV-GSA in January 2022. The GSP is available at <https://scvgsa.org/wp-content/uploads/2021/12/SCV-GSP-Sections-Combined-20211217.pdf>. The GSP was in large part built on the GWMP with the groundwater basin operating within the yields identified in the GWMP. A summary of GWMP and the GSP are provided below.

3.3.2.1 Groundwater Sustainability Plan

The Santa Clarita Valley Groundwater Sustainability Agency (SCV-GSA) operates under a Joint Powers Agreement, which was executed by member Agencies in 2018. The SCV-GSA has adopted the State-required GSP for the East Subbasin of the Santa Clara River Valley Groundwater Basin. The plan represents a significant multi-year undertaking concluding with its adoption and submittal to DWR in January 2022. Development of the GSP reflected a significant stakeholder engagement effort with the involvement of a Stakeholder Advisory Committee to reflect the views from private well owners, members at large, environmental interests, and the business community. This Stakeholder Advisory Committee met regularly to review technical memoranda and provide advisement to the GSA on materials and assistance with several public workshops.

The final Board- adopted GSP is consistent with the current groundwater operating plan as described in the GWMP (AB 3030 plan), and its 2009 update, described below. The GSP, however refined the technical

analysis as it utilized a new groundwater flow model (an unstructured grid version of ModFlow called ModFlow USG) that models the groundwater operating plan. These refinements include updates such as redistribution of pumping and current Basin conditions. The plan also developed minimum thresholds as a basis to determine that the groundwater basin is being managed in a sustainable manner. The SCV-GSA will conduct the required annual monitoring and reports for the GSP.

3.3.2.2 Groundwater Management Plan

The general contents of the GWMP were outlined in 2002, and a detailed plan was adopted in 2003 to satisfy the requirements of AB 134. The plan both complements and formalizes a number of existing water supply and water resource planning and management activities in SCV Water's service area, which effectively encompass the East Subbasin of the Santa Clara River Valley Groundwater Basin. Notably, the GWMP also includes a basin-wide monitoring program, the results of which provide input to annual reporting on water supplies and water resources in the Basin, as well as input to assessment of Basin yield for water supply as described herein. Groundwater level data from the existing groundwater monitoring program is reported to DWR as part of SBX7-6 implementation CASGEM. SCV Water serves as the monitoring entity for CASGEM for the basin. Available groundwater level data for the CASGEM program is submitted twice a year. SCV Water will continue to provide groundwater level data consistent with the CASGEM program.

The GWMP contains four management objectives, or goals, for the Basin including (1) development of an integrated surface water, groundwater and recycled water supply to meet existing and projected demands for municipal, agricultural and other water uses; (2) assessment of groundwater basin conditions to determine a range of operational yield values that use local groundwater conjunctively with supplemental SWP supplies and recycled water to avoid groundwater overdraft; (3) preservation of groundwater quality, including active characterization and resolution of any groundwater contamination problems, and (4) preservation of interrelated surface water resources, which includes managing groundwater to not adversely impact surface and groundwater discharges or quality to downstream basin(s).

Prior to preparation and adoption of the GWMP, a local MOU process among the former CLWA, the CLWA retail water purveyors and UWCD in neighboring Ventura County, downstream of the East Subbasin of the Santa Clara River Valley, produced the beginning of local groundwater management. This is now embodied in the GWMP prepared and implemented in 2001. The MOU was a collaborative and integrated approach to several aspects of water resource management included in the GWMP. As a result of the MOU, the cooperating agencies integrated their respective database management efforts and continued to monitor and report on the status of Basin conditions, as well as on geologic and hydrologic aspects of their respective parts of the overall stream-aquifer system. Following adoption of the GWMP, the water suppliers developed and utilized a numerical groundwater flow model for analysis of groundwater basin yield and for analysis of extraction and containment of groundwater contamination. The results of those basin yield and contamination analyses, updated in 2009 by Luhdorff and Scalmanini Consulting Engineers and GSI Water Solutions, Inc. (LSCE & GSI, 2009), are bases for the amounts and allocations of groundwater supplies in the 2020 UWMP.

The adopted GWMP includes 14 elements intended to accomplish the Basin management objectives listed above. In summary, the plan elements include:

- Monitoring of groundwater levels, quality, production, and subsidence

- Monitoring and management of surface water flows and quality
- Determination of Basin yield and avoidance of overdraft
- Development of regular and dry-year emergency water supply
- Continuation of conjunctive use operations
- Long-term salinity management
- Integration of recycled water
- Identification and mitigation of soil and groundwater contamination, including involvement with other local agencies in investigation, cleanup, and closure
- Development and continuation of local, state, and federal agency relationships
- Groundwater management reports
- Continuation of public education and water conservation programs
- Identification and management of recharge areas and wellhead protection areas
- Identification of well construction, abandonment, and destruction policies
- Provisions to update the groundwater management plan

Work on a number of the GWMP elements had been ongoing for some time prior to the formal adoption of the GWMP and expanded work on implementation of the GWMP will continue on an ongoing basis through the administration of the GSP. The GSP evaluates the operating plan going forward and these analyses of the groundwater basin are reflected in the 2020 UWMP and this WSA. Notable in the implementation of the GWMP has been the annual preparation of a Santa Clarita Valley Water Report (Annual Report) that summarizes (1) water requirements, (2) all three sources of water supply (groundwater, imported surface water and recycled water, all as part of the GWMP's overall management objectives), and (3) projected water supply availability to meet the following year's projected water requirements. Besides for addressing GWMP requirements, the Annual Report is also prepared in response to a request by the Los Angeles County Board of Supervisors and the MOU between the water purveyors in the Basin and UWCD. SGMA also requires preparation of an annual report on basin conditions. The first report being due in April of 2022 will address much of the same information but framed in the context of the GSP Sustainability Criteria discussed below.

3.3.2.3 Available Groundwater Supplies

The groundwater component of overall water supply in the Valley derives from a groundwater operating plan developed and analyzed to meet water requirements (municipal, agricultural, small domestic) while maintaining the Basin in a sustainable condition, specifically no long-term depletion of groundwater or interrelated surface water. The operating plan also addresses groundwater contamination issues in the Basin, all consistent with the GWMP described above. The groundwater operating plan and the GSP are based on the concept that pumping can vary from year to year to allow increased groundwater use in dry periods and increased recharge during wet periods to collectively assure that the groundwater Basin is adequately replenished through various wet/dry cycles. As ultimately formalized in the GWMP and described in the Basin Yield Report (LSCE and GSI, 2009), and in the GSP, the operating yield concept has been quantified as ranges of annual pumping volumes to capture year-to-year pumping fluctuations in response to both hydrologic conditions and customer demand.

Ongoing work through implementation of the GWMP has produced three detailed technical reports in addition to the annual Water Reports (the most recent of which, for 2020, was the twenty-third annual report). The first detailed technical report (CH2M Hill, April 2004) documents the construction and calibration of the groundwater flow model for the Valley. The second report (CH2M Hill and LSCE, August 2005) presents the initial modeling analysis of the purveyors' original groundwater operating plan. The

most recent report, an updated analysis of the Basin (LSCE & GSI, 2009) presents the modeling analysis of the current groundwater operating plan, including restoration of two Saugus Formation wells for municipal supply after treatment and also presents a range of potential impacts deriving from climate change considerations. All those results are reflected in this WSA. The primary conclusion of the technical analysis is that the groundwater operating plan will not cause detrimental short- or long-term effects to the groundwater and surface water resources in the Valley and is therefore sustainable. The analysis of sustainability for groundwater and interrelated surface water is described in detail in “Analysis of Groundwater Supplies and Groundwater Basin Yield, USCR Groundwater Basin, East Subbasin” (Basin Yield Analysis) prepared August 2009 (LSCE & GSI, 2009).

Additional technical work performed for the SCV-GSA in preparation of its GSP confirmed previous conclusions that the basin plan was sustainable. Utilizing the new MODFLOW-USG model, additional analysis of the basin plan operating plan was performed for the Water Budget Development for the Santa Clara River Valley East Groundwater Subbasin report, GSI Water Solutions Inc, October 2021. The analysis was based on the existing operating plan, modified spatial pumping distribution, incorporated updated climate change data, and made other refinements. The analysis concluded that chronic lowering of groundwater levels and groundwater storage would not occur under the operating plan and therefore operation was within the safe yield of the Basin.

The updated groundwater operating plan (LSCE & GSI, 2009), as well as operations anticipated under the GSP are summarized in Table 3-2, is as follows:

Alluvium: Pumping from the Alluvial Aquifer in a given year is governed by local hydrologic conditions in the eastern Santa Clara River Watershed. Pumping for municipal, agricultural, and private purposes ranges between 30,000 and 40,000 AFY during normal and above-normal rainfall years. However, due to hydrogeologic constraints in the eastern part of the Basin along with distribution of groundwater pumping, pumping is reduced to between 30,000 and 35,000 AFY during locally dry years. These amounts result in an ability to operate supply wells in the Basin in a feasible and sustainable manner.

Saugus Formation: Pumping from the Saugus Formation in a given year is tied directly to the availability of other water supplies, particularly from the SWP. During average-year conditions within the SWP system, Saugus pumping ranges between 7,500 and 15,000 AFY. Planned dry-year pumping from the Saugus Formation ranges between 15,000 and 25,000 AFY during a drought year and can increase to between 21,000 and 25,000 AFY if SWP deliveries are reduced for two consecutive years and between 21,000 and 35,000 AFY if SWP deliveries are reduced for three consecutive years. Such high pumping would be followed by periods of reduced (average-year) pumping, at rates between 7,500 and 15,000 AFY, to further enhance the effectiveness of natural recharge processes that would recover water levels and groundwater storage volumes after the higher pumping during years with low SWP allocations.

**TABLE 3-2
GROUNDWATER OPERATING PLAN FOR THE SANTA CLARITA VALLEY**

Aquifer	Groundwater Production (AF)			
	Normal Years	Dry Year 1	Dry Year 2	Dry Years 3-5
Alluvium	30,000 to 40,000	30,000 to 35,000	30,000 to 35,000	30,000 to 35,000
Saugus Formation	7,500 to 15,000	15,000 to 25,000	21,000 to 25,000	21,000 to 35,000
Total	37,500 to 55,000	45,000 to 60,000	51,000 to 60,000	51,000 to 70,000

Within the groundwater operating plan, three factors affect the availability of groundwater supplies: sufficient source capacity (wells and pumps), sustainability of the groundwater resource to meet pumping demand on a renewable basis, and protection of groundwater sources (wells) from known contamination, or provisions for treatment in the event of contamination. These factors are discussed below.

Protection of groundwater sources and provisions for treatment in the event of contamination is briefly discussed below and discussed further in Section 4.

Perchlorate has been a water quality concern since 1997 when first detected in SCV Water’s service area. Several Saugus Formation and Alluvial wells were initially removed from service. Treatment facilities for two wells, Saugus 1 and Saugus 2, have been installed and are currently operational. A treatment facility has been installed for the V201 well and awaits final permitting. Treatment system design has been initiated for Well 205. Additionally, two new wells, Saugus 3 and 4 have been designed and await permitting from DDW prior to drilling. Additional details on DDW permitting and associated timeline for Saugus wells are provided in Section 4.

Recently, USEPA provided a health advisory of lifetime exposure to PFOA and PFOS of 70 parts per trillion (or 70 nanogram per liter (ng/l)) for polyfluoroalkyl substances (PFAS). The health advisory is non-enforceable and non-regulatory and is intended to provide technical information to local and state agencies. In August of 2019, DDW set notification level (NL) and response levels for various PFAS constituents. SCV Water wells were tested and as of February 2020, over 60% of Alluvium wells exceeded the NL or RL resulting in 18 wells being taken out of service. Treatment for three of these wells (N-Wells) has been installed and the wells are now operational. Construction is also currently underway at the Valley Center Wells with a scheduled completion in 2022. Design is underway for treatment of two additional wells, Honby and Santa Clara, scheduled to be back online by 2023. Preliminary design for an additional 6 wells is under way and they are anticipated to be back online between 2024 and 2025. The remaining wells are anticipated to have treatment installed by 2030.

During this interim period of operation, pumping from non-impacted alluvium wells and Saugus Formation wells will be increased to partially mitigate for lost production capacity. The pumping distribution for alluvium wells and Saugus wells is shown in Table 3-4A and Table 3-4B respectively and summarized in Table 3-4 below. The originally anticipated schedule for installation of treatment for alluvium wells and Saugus Formation wells is contained in Appendix E of the 2020 UWMP. Updated Detailed Water Supply Tables are provided in Tables 3-4B, 3-4C, 3-5B and 3-5C (these tables updated planning and construction and permitting schedules and have been prepared in consultation with SCV Water’s Engineering and Operations divisions.). For example, the online date for Saugus Formation Well 201 was changed from 2022 to 2024 to reflect inclusion of VOC treatment facilities. Similarly, the Santa Clara and Honby alluvial wells, originally scheduled to be online in 2023, are now scheduled to be available in 2024 to reflect

scheduling experience gained from the previously treatment facilities constructed at the N wells. These tables reflect a likely operation moving forward but will be adjusted to reflect operational conditions that may develop.

Recent historical groundwater pumping by SCV Water and other groundwater users is summarized in Table 3-3. The quantity of groundwater used can significantly vary year to year based on a number of factors. For example, in 2016 continued dry conditions in northern California resulted in an allocation of only 20% of SCV Water’s Table A amount and SCV Water relied more heavily on groundwater. In contrast 2017 and 2019 were wet years in the watersheds that provide SWP supplies, and higher SWP allocations allowed SCV Water to reduce groundwater extraction allowing the basin to recover storage. 2020 groundwater production was significantly curtailed due to newly implemented PFAS regulatory actions.

Planned future groundwater pumping in normal years, by the retail water purveyors as well as by other groundwater users, is summarized in Table 3-4. Existing and planned groundwater pumping by SCV Water as well as by other groundwater users, for normal, single-dry and multiple-dry year periods, are summarized in Section 4 and in Table 3-6 through Table 3-8 below.

**TABLE 3-3
RECENT HISTORICAL GROUNDWATER PRODUCTION (AF)^(a)**

Santa Clara River Valley East Subbasin	2016	2017	2018	2019	2020
SCWD	6,892	3,900	5,383	5,948	5,311
Alluvium	3,485	907	2,465	2,762	2,517
Saugus Formation ^(b)	3,407	2,993	2,918	3,186	2,794
LACWWD 36	1,047	1,093	1,204	972	1,257
Alluvium	0	0	0	0	0
Saugus Formation	1,047	1,093	1,204	972	1,257
NCWD/NWD	4,468	2,303	2,608	3,708	4,591
Alluvium	626	780	728	1,044	1,322
Saugus Formation	3,842	1,523	1,880	2,664	3,269
VWC/VWD	13,922	9,107	13,674	6,919	6,173
Alluvium	11,133	7,737	10,837	5,243	3,732
Saugus Formation	2,789	1,370	2,837	1,676	2,441
Total Purveyor	26,329	16,403	22,869	17,547	17,332
Alluvium	15,244	9,424	14,030	9,049	7,571
Saugus Formation	11,085	6,979	8,839	8,498	9,761
Agricultural and Other^{(d)(c)}	14,359	13,438	13,071	12,510	12,300
Alluvium	13,605	12,554	12,437	11,967	9,190
Saugus Formation	754	884	843	1,067	1,060
Total Basin	40,688	29,841	36,149	30,581	27,582
Alluvium	28,849	21,978	26,467	21,016	16,761
Saugus Formation	11,839	7,863	9,682	9,565	10,821
Groundwater Fraction of Total Municipal Water Supply	56%	39%	46%	42%	36%

Notes:

- (a) From 2019 Santa Clarita Valley Water Report (July 2020) and recorded amounts for 2020.
- (b) Represents pumping from Saugus 1 and Saugus 2 wells.
- (c) Includes agricultural and other small private well pumping.
- (d) 2020 Agricultural and Other alluvial production includes Pitches Detention Center = 1,282 AF, Sand Canyon Country Club 116 AF, Small Pumpers = 500 AF and 2020 Newhall Land and Farming pumping = 7,292 AF for a total of 9,190 AF. Saugus includes private irrigation pumping from Valencia Country Club and Vista Valencia Golf Course 612 AF Saugus and Whittaker Bermite Treatment = 448 AF, for a total of 1,060 AF.

**TABLE 3-4
PROJECTED GROUNDWATER PRODUCTION (NORMAL YEAR) (AF)**

Basin Name	Groundwater Pumping (AF)					
	2025	2030	2035	2040	2045	2050
Santa Clara River Valley East Subbasin						
Purveyor						
Alluvium ^(a)	19,240	28,050	30,790	30,790	30,790	30,790
Saugus Formation ^(b)	17,450	9,900	9,900	9,900	9,900	9,900
Total Purveyor	36,690	37,950	40,690	40,690	40,690	40,690
Non-Purveyor (Agricultural and Other)^(c)						
Alluvium ^(d)	11,540	9,150	6,410	6,410	6,410	6,410
Saugus Formation	1,200	1,200	1,200	1,200	1,200	1,200
Total Agricultural and Other	12,740	10,350	7,610	7,610	7,610	7,610
Basin						
Alluvium	30,780	37,200	37,200	37,200	37,200	37,200
Saugus Formation	18,650	11,100	11,100	11,100	11,100	11,100
Total Basin	49,430	48,300	48,300	48,300	48,300	48,300

Notes:

- (a) Includes existing, future (associated with the assumed development under the Newhall Ranch Specific Plan) and recovered pumping capacity after PFAS and Perchlorate treatment.
- (b) Saugus Normal Year pumping in 2025 is higher than normal to mitigate for lost alluvial pumping capacity due to impacted PFAS wells.
- (c) Non purveyor pumping includes Five Point (Newhall Ranch Agriculture), Pitches Detention Center, and Small Private Domestic pumping and irrigation at Sand Canyon Country Club, private irrigation pumping from Valencia Country Club and Vista Valencia Golf Course, as well as projected Whittaker-Bermite pumping for perchlorate treatment.
- (d) Reflects reduction of up to 7,038 AF associated with the assumed development under the Newhall Ranch Specific Plan.

As reflected in Table 3-4, the groundwater operating plan recognizes ongoing pumping for the two major uses of groundwater in the Basin, municipal and agricultural (including private pumpers) water supply. Consistent with the groundwater operating plan, projected groundwater pumping includes an ongoing conversion of pumping, coincident with planned land-use changes, from agricultural to municipal water supply. This is shown in Table 3-4, with projected pumping by agricultural and other users decreasing as purveyor pumping increases in such a manner that overall pumping remains within the basin operating plan. The reduction in pumping for agricultural supply is primarily due to the development of Newhall Ranch (expected buildout date of 2034) and is expected to shift to an increase in pumping by SCV Water. The groundwater operating plan and projected pumping also includes other small private domestic and related pumping. As shown in Table 3-4, total projected groundwater pumping by all users within each aquifer is within the ranges for normal year pumping identified in the groundwater operating plan (Table 3-2). SCV Water recognizes that these estimates of projected groundwater use are subject to adjustment based on various factors and conditions occurring from time to time. These estimates are provided for the planning purposes of this report and the UWMP, and do not constitute an allocation of groundwater from the local groundwater basins.

3.3.2.4 Alluvium

Based on a combination of historical operating experience and groundwater modeling analyses (2005 and 2009 groundwater operation plan updates), the Alluvial Aquifer can supply groundwater on a long-term

sustainable basis in the overall range of 30,000 to 40,000 AFY, with a probable reduction in dry years to a range of 30,000 to 35,000 AFY. Both of those ranges include 13,000 to 6,400 AFY (as reflected in Table 3-6 and Table 3-7) of Alluvial pumping for agricultural and other non-municipal water uses. The dry year reduction is a result of practical constraints in the eastern part of the Basin, where lowered groundwater levels in dry periods have the effect of reducing pumping capacities in that shallower portion of the aquifer. The GSP will also consider potential impacts on Groundwater Dependent Ecosystems throughout the basin and available analysis supports a determination that historic pumping patterns and future pumping patterns consistent with the Groundwater Basin Operating Plan were protective of these systems. In addition, in general, increased water conservation practices are expected to reduce both indoor and outdoor irrigation demands. Less outdoor irrigation water use creates less return flow to the basin and less indoor water use creates less recycled water both for use within SCV Water and for return to the Santa Clara River. SCV Water will monitor these effects to ensure that pumping by SCV Water does not impact groundwater supply for other uses, including groundwater dependent ecology. Additionally, it is anticipated that the SCV-GSA will monitor groundwater conditions and implement management actions if Sustainable Management Criteria, or Groundwater Dependent Ecosystem triggers are reached so as to protect resources and ensure sustainable operation of the basin.

One notable change in the future geographic patterns of production compared to historical distributions concerns the historic distribution of agricultural pumping compared to future distribution among SCV Water wells. Under the Newhall Ranch Specific Plan, NLF is to dedicate up to 7,038 AFY by fallowing lands and reducing agricultural pumping on its lands. Under the Specific Plan, SCV Water would then have the ability to pump water to serve the new development. The project will be constructed in stages over a number of years depending on market conditions. Likewise, SCV Water pumping would increase over time in such a manner that the overall pumping remains within the basin operating plan. The Specific Plan development is projecting to implement water conservation practices which will reduce both indoor and outdoor irrigation demands. This reduces the overall water demand of the development. Consistent with the above, SCV Water will monitor the transfer of water from NLF to ensure it does not impact other uses

If the 7,038 AFY dedicated by NLF is not sufficient to support the Specific Plan Development, NLF (or its successor in interest), will transfer additional water to SCV Water from the Nickel Water and/or the Semitropic Water Bank to backstop demands. In anticipation of this development, VWC, a PUC regulated private utility then owned by NLF, installed four wells. However, to manage future potential reductions in groundwater levels in the vicinity of these new wells, particularly during drought conditions, the GSP Water Budget Analysis indicated it would be desirable to install several wells located near the confluence of Castaic Creek and the Santa Clara River near the existing "C" wells that are currently used for agricultural production for Newhall Land's operations in Los Angeles County.

Adequacy of Supply

Three factors affecting the availability of groundwater are (1) sufficient source infrastructure capacity (wells and pumps), (2) sustainability of the groundwater resource to meet pumping demand on a renewable basis, and (3) protection of groundwater sources (wells) from known contamination or from potential sources of contamination.

For source infrastructure, existing and planned wells, and pumps, SCV Water has a combined pumping capacity from active Alluvial wells of approximately 51,000 gallons per minute (gpm), which translates into a current full-time Alluvial source pumping capacity of approximately 83,000 AFY. The higher individual and cumulative pumping capacities are primarily for operational reasons (i.e., to meet daily and other

fluctuations from average day to maximum day and peak hour system demands). Further, to achieve these levels of production, SCV Water must complete treatment facilities for PFAS compliance. The timing for returning PFAS and Perchlorate impacted wells is shown in the 2020 UWMP and incorporated herein. Alluvial pumping capacity from all the active and future municipal supply wells is summarized in Table 3-4C.

In terms of adequate source capacity to provide flexible and adaptive management in the sustainable use of groundwater resources, the current and projected availability of Alluvial groundwater source capacity of municipal wells is approximately 83,000 AFY. This source capacity is more than sufficient to meet the 21,400 AFY in 2025 and increases to 30,800 in 2035 (Table 3-4). The higher individual and cumulative pumping capacities are primarily for operational reasons (i.e., to meet daily and other fluctuations from average day to maximum day and peak hour system demands). As illustrated on Table 3-4C, the balance of all Alluvial pumping 37,200 AFY, including non-SCV Water pumping, remains within the operating plan range of 30,000 to 40,000 AFY.

**TABLE 3-4A
ACTIVE MUNICIPAL GROUNDWATER SOURCE CAPACITY
ALLUVIAL AQUIFER WELLS^(a)**

Well	Permitted Capacity ⁽ⁱ⁾ (gpm)	Max. Annual Capacity ⁽ⁱ⁾ (AF)	GSP Water Budget Analysis ^{(b)(i)}	
			Normal Year (AF)	Dry Year (AF)
Existing Wells^(c)				
Castaic 1	640	1,030	430	420
Castaic 2	500	810	220	220
Castaic 4	330	530	-	-
Castaic 6	600	970	-	-
Castaic 7	2,000	3,230	580	730
Pinetree 3	550	890	310	-
Pinetree 4	500	810	-	-
Guida	1,000	1,610	560	560
Lost Canyon 2 ^(d)	800	1,290	410	250
Lost Canyon 2A ^(d)	1,000	1,610	420	160
N. Oaks West	750	1,210	-	-
Sand Canyon	1,200	1,940	730	310
Well E-15 ^(d)	1,400	2,260	725	620
Well W9	800	1,290	1,010	700
Well W11	1,000	1,610	1,180	1,000
Well E-17 ^(d)	1,200	1,940	725	620
<i>Existing Subtotal</i>	<i>14,270</i>	<i>23,030</i>	<i>7,300</i>	<i>5,590</i>
Future^e and Recovered Wells				
Pinetree 1 ^(f)	300	480	190	0
Pinetree 5 ^(f)	500	810	200	0
Clark ^(f)	550	890	380	270
Honby ^(f)	950	1,530	760	110
Mitchell 5B ^(f)	1,000	1,610	200	60
N. Oaks Central ^(f)	1,200	1,940	500	340
N. Oaks East ^(f)	950	1,530	500	220
Santa Clara ^(f)	1,500	2,420	770	250
Sierra ^(f)	1,000	1,610	400	60
Valley Center ^(f)	1,200	1,940	1,000	610

Well	Permitted Capacity ⁽ⁱ⁾ (gpm)	Max. Annual Capacity ⁽ⁱ⁾ (AF)	GSP Water Budget Analysis ^{(b)(i)}	
			Normal Year (AF)	Dry Year (AF)
Well D ^(f)	1,050	1,690	1,210	920
Well N ^(f)	1,250	2,020	630	1,060
Well N7 ^(f)	2,500	4,040	1,470	1,680
Well N8 ^(f)	2,500	4,040	1,430	1,680
Well Q2 ^{(g)(f)}	1,200	1,940	770	850
Well S6 ^(f)	2,000	3,230	640	2,080
Well S7 ^(f)	2,000	3,230	620	780
Well S8 ^(f)	2,000	3,230	610	760
Well T7 ^(f)	1,200	1,940	880	360
Well U4 ^(f)	1,000	1,610	940	570
Well U6 ^(f)	1,250	2,020	1,050	660
Well W10 ^(f)	1,500	2,420	1,700	1,490
Well E-14 ^(h)	1,200	1,940	725	610
Well E-16 ^(h)	1,200	1,940	725	610
Well G-45 ^(h)	1,200	1,940	1,670	1,430
Well C-11 ^(h)	2,000	3,230	1,600	1,360
Well C-12 ^(h)	2,000	3,230	1,600	1,360
S9 (Mitchell 5A Replacement) ^(h)	1,000	1,610	320	320
<i>Future Subtotal</i>	<i>37,200</i>	<i>60,060</i>	<i>23,490</i>	<i>20,500</i>
Total	51,470	83,090	30,790	26,090

Notes:

- (a) The quantities of groundwater extracted by existing or future and recovered well capacity will vary depending on operating conditions. However, overall pumping remains within the groundwater basin yields per the GSP (GSI 2022) and the updated Basin Yield Analysis (LSC & GSI 2009).
- (b) Production for Normal and Dry years represented in this table represent the period after all impacted wells (PFAS and Perchlorate impacts) are recovered. Dry-year production represents anticipated maximum dry year production. Schedule for recovered well capacity based on Groundwater Treatment Implementation Plan Technical Memorandum, Kennedy Jenks 2021 in Appendix M of the 2020 UWMP.
- (c) Existing Category includes all wells currently online and in use.
- (d) E Wells and Lost Canyon have been below the RL so are not impacted wells, but they are anticipated to be connected into central treatment systems.
- (e) Future Category includes all wells restored from PFAS and Perchlorate water quality issues, and other future alluvial wells including those associated with development under the Newhall Ranch Specific Plan.
- (f) PFAS impacted well.
- (g) Perchlorate impacted well.
- (h) Future wells.
- (i) Permitted and Max. Annual Capacity for wells does not represent anticipated annual water supply provided by the wells. Anticipated water supply from the wells is shown in the GSP Water Budget Analysis columns.

**TABLE 3-4B
ACTIVE MUNICIPAL GROUNDWATER SOURCE CAPACITY
EXISTING, FUTURE AND RECOVERED ALLUVIAL AQUIFER WELLS^(a)
NORMAL YEAR DETAIL (2021-2030)**

Well	Permit Capacity ⁽ⁱ⁾ (gpm)	Max. Capacity ⁽ⁱ⁾ (AFY)	Normal Year (AF)(b)									
			2021	2022	2023	2024	2025	2026	2027	2028	2029	2030
Existing Wells^(c)												
Castaic 1	640	1,030	430	430	430	430	430	430	430	430	430	430
Castaic 2	500	810	220	220	220	220	220	220	220	220	220	220
Castaic 4	330	530	-	-	-	-	-	-	-	-	-	-
Castaic 6	600	970	-	-	-	-	-	-	-	-	-	-
Castaic 7	2,000	3,230	580	580	580	580	580	580	580	580	580	580
Pinetree 3	550	890	310	310	310	310	310	310	310	310	310	310
Pinetree 4	500	810	-	-	-	-	-	-	-	-	-	-
Guida	1,000	1,610	560	560	560	560	560	560	560	560	560	560
Lost Canyon 2 ^(d)	800	1,290	410	410	410	410	410	410	410	410	410	410
Lost Canyon 2A ^(d)	1,000	1,610	420	420	420	420	420	420	420	420	420	420
N. Oaks West	750	1,210	-	-	-	-	-	-	-	-	-	-
Sand Canyon	1,200	1,940	730	730	730	730	730	730	730	730	730	730
Well E-15 ^(d)	1,400	2,260	1,680	1,680	1,680	1,680	1,680	1,680	1,680	1,680	1,600	1,600
Well W9	800	1,290	1,030	1,030	1,030	1,030	1,030	1,030	1,030	1,030	1,010	1,010
Well W11	1,000	1,610	1,240	1,240	1,240	1,240	1,240	1,240	1,180	1,180	1,180	1,180
Well E-17 ^(d)	1,200	1,940	1,290	1,290	1,290	1,290	1,290	1,290	1,290	1,290	730	730
Existing Subtotal	14,270	23,030	8,900	8,900	8,900	8,900	8,900	8,900	8,840	8,840	8,180	8,180
Future and Recovered Wells												
Pinetree 1 ^(f)	300	480	-	-	-	-	-	-	-	-	-	190
Pinetree 5 ^(f)	500	810	-	-	-	-	-	-	-	-	-	200
Clark ^(f)	550	890	-	-	-	-	-	-	-	-	-	380
Honby ^(f)	950	1,530	-	-	-	760	760	760	760	760	760	760

Mitchell 5B ^(f)	1,000	1,610	-	-	-	-	-	-	-	-	-	200
N. Oaks Central ^(f)	1,200	1,940	-	-	-	-	-	-	-	-	-	500
N. Oaks East ^(f)	950	1,530	-	-	-	-	-	-	-	-	-	500
Santa Clara ^(f)	1,500	2,420	-	-	-	1,010	1,010	1,010	1,010	1,010	1,010	1,010
Sierra ^(f)	1,000	1,610	-	-	-	-	-	-	-	-	-	400
Valley Center ^(f)	1,200	1,940	-	1,190	1,190	1,030	1,030	1,030	1,030	1,030	1,030	1,030
Well D ^(f)	1,050	1,690	-	-	-	-	-	-	-	1,210	1,210	1,210
Well N ^(f)	1,250	2,020	980	1,000	870	870	630	630	630	630	630	630
Well N7 ^(f)	2,500	4,040	1,800	1,800	2,180	2,180	1,470	1,470	1,470	1,470	1,470	1,470
Well N8 ^(f)	2,500	4,040	1,800	1,800	1,800	2,180	1,430	1,430	1,430	1,430	1,430	1,430
Well Q2 ^{(g)(f)}	1,200	1,940	-	940	940	940	770	770	770	770	770	770
Well S6 ^(f)	2,000	3,230	-	-	-	-	-	640	640	640	640	640
Well S7 ^(f)	2,000	3,230	-	-	-	-	-	620	620	620	620	620
Well S8 ^(f)	2,000	3,230	-	-	-	-	-	610	610	610	610	610
Well T7 ^(f)	1,200	1,940	-	-	-	-	750	750	750	750	750	750
Well U4 ^(f)	1,000	1,610	-	-	-	-	700	700	700	700	700	700
Well U6 ^(f)	1,250	2,020	-	-	-	-	800	800	800	800	800	840
Well W10 ^(f)	1,500	2,420	-	-	-	-	-	-	1,650	1,650	1,650	1,650
Well E-14 ^(h)	1,200	1,940	-	-	-	-	370	740	740	740	740	740
Well E-16 ^(h)	1,200	1,940	-	-	-	-	125	650	650	650	650	650
Well G-45 ^(h)	1,200	1,940	-	-	-	-	-	-	-	-	1,670	1,670
Well C-11 ^(h)	2,000	3,230	-	-	-	-	-	-	-	-	-	-
Well C-12 ^(h)	2,000	3,230	-	-	-	-	-	-	-	-	-	-
S9 ^(h)	1,000	1,610	-	-	-	-	-	320	320	320	320	320
Future Subtotal	37,200	60,060	4,580	6,730	6,980	8,970	9,845	12,930	14,580	15,790	17,460	19,870
Total	51,470	83,090	13,480	15,630	15,880	17,870	18,745	21,830	23,420	24,630	25,640	28,050

Notes:

- (a) The quantities of groundwater extracted by existing or future and recovered well capacity will vary depending on operating conditions. However, overall pumping remains within the groundwater basin yields per the 2020 SCV-GSA Water Budget Development Tech Memo (GSI 2020) and the updated Basin Yield Analysis (LSC & GSI 2009).

- (b) Schedule for recovered well capacity based on Groundwater Treatment Implementation Plan Technical Memorandum, Kennedy Jenks 2021 in Appendix M of the 2020 UWMP. 2023 through 2025 adjustments based on August 2022 engineering project schedule updates.
- (c) Existing Category includes all wells currently online and in use.
- (d) E Wells and Lost Canyon have not come below the RL so are not impacted wells but are anticipated to be connected into central treatment systems.
- (e) Future Category includes all wells restored from PFAS and Perchlorate water quality issues, and other future alluvial wells including those associated with development under the Newhall Ranch Specific Plan.
- (f) PFAS impacted well.
- (g) Perchlorate impacted well.
- (h) Future wells.
- (i) Permitted and Max. Annual Capacity for wells does not represent anticipated water supply provided by wells.

**TABLE 3-4C
ACTIVE MUNICIPAL GROUNDWATER SOURCE CAPACITY
EXISTING, FUTURE AND RECOVERED ALLUVIAL AQUIFER WELLS^(a)
DRY YEAR DETAIL (2021-2030)**

Well	Permit Capacity ⁽ⁱ⁾ (gpm)	Max. Capacity ⁽ⁱ⁾ (AFY)	Dry Year (AF) ^(b)										
			2021	2022	2023	2024	2025	2026	2027	2028	2029	2030	
Existing Wells^(c)													
Castaic 1	640	1,030	420	420	420	420	420	420	420	420	420	420	420
Castaic 2	500	810	220	220	220	220	220	220	220	220	220	220	220
Castaic 4	330	530	-	-	-	-	-	-	-	-	-	-	-
Castaic 6	600	970	-	-	-	-	-	-	-	-	-	-	-
Castaic 7	2,000	3,230	730	730	730	730	730	730	730	730	730	730	730
Pinetree 3	550	890	0	0	0	0	0	0	0	0	0	0	0
Pinetree 4	500	810	-	-	-	-	-	-	-	-	-	-	-
Guida	1,000	1,610	560	560	560	560	560	560	560	560	560	560	560
Lost Canyon 2 ^(d)	800	1,290	250	250	250	250	250	250	250	250	250	250	250
Lost Canyon 2A ^(d)	1,000	1,610	160	160	600	600	600	160	160	160	160	160	160
N. Oaks West	750	1,210	-	-	-	-	-	-	-	-	-	-	-
Sand Canyon	1,200	1,940	310	310	700	700	700	310	310	310	310	310	310
Well E-15 ^(d)	1,400	2,260	1,440	1,440	1,440	1,440	1,440	1,440	1,440	1,440	1,440	1,440	1,360
Well W9	800	1,290	940	940	940	940	940	940	940	940	940	940	700
Well W11	1,000	1,610	1,210	1,210	1,210	1,210	1,210	1,210	1,210	1,210	1,210	1,210	1,000
Well E-17 ^(d)	1,200	1,940	1,060	1,060	1,060	1,060	1,060	1,060	1,060	1,060	1,060	1,060	620
Existing Subtotal	14,270	23,030	7,300	7,300	8,130	8,130	8,130	7,300	7,300	7,300	7,300	7,300	6,330
Future and Recovered Wells													
Pinetree 1 ^(f)	300	480	-	-	-	-	-	-	-	-	-	-	0
Pinetree 5 ^(f)	500	810	-	-	-	-	-	-	-	-	-	-	0
Clark ^(f)	550	890	-	-	-	-	-	-	-	-	-	-	270
Honby ^(f)	950	1,530	-	-	800	800	110	110	110	110	110	110	110
Mitchell 5B ^(f)	1,000	1,610	-	-	-	-	-	-	-	-	-	-	60
N. Oaks Central ^(f)	1,200	1,940	-	-	-	-	-	-	-	-	-	-	340

Well	Permit Capacity (gpm)	Max. Capacity (AFY)	Dry Year (AF) ^(b)										
N. Oaks East ^(f)	950	1,530	-	-	-	-	-	-	-	-	-	-	220
Santa Clara ^(f)	1,500	2,420	-	-	-	800	800	250	250	250	250	250	
Sierra ^(f)	1,000	1,610	-	-	-	-	-	-	-	-	-	60	
Valley Center ^(f)	1,200	1,940	-	800	1000	1000	1000	610	610	610	610	610	
Well D ^(f)	1,050	1,690	-	-	-	-	-	-	-	920	920	920	
Well N ^(f)	1,250	2,020	1,060	1,060	1,060	1,060	1,060	1,060	1,060	1,060	1,060	1,060	
Well N7 ^(f)	2,500	4,040	2,310	2,310	2,100	2,310	2,310	1,680	1,680	1,680	1,680	1,680	
Well N8 ^(f)	2,500	4,040	2,310	2,310	1,800	2,100	2,310	1,680	1,680	1,680	1,680	1,680	
Well Q2 ^{(g)(f)}	1,200	1,940	-	1,110	1,110	1,110	1,110	850	850	850	850	850	
Well S6 ^(f)	2,000	3,230	-	-	-	-	-	2,080	2,080	2,080	2,080	2,080	
Well S7 ^(f)	2,000	3,230	-	-	-	-	-	780	780	780	780	780	
Well S8 ^(f)	2,000	3,230	-	-	-	-	-	760	760	760	760	760	
Well T7 ^(f)	1,200	1,940	-	-	-	-	360	360	360	360	360	360	
Well U4 ^(f)	1,000	1,610	-	-	-	-	570	570	570	570	570	570	
Well U6 ^(f)	1,250	2,020	-	-	-	-	660	660	660	660	660	660	
Well W10 ^(f)	1,500	2,420	-	-	-	-	-	-	1,030	1,030	1,030	1,490	
Well E-14 ^(h)	1,200	1,940	-	-	-	-	310	620	620	620	620	620	
Well E-16 ^(h)	1,200	1,940	-	-	-	-	290	580	580	580	580	580	
Well G-45 ^(h)	1,200	1,940	-	-	-	-	-	-	-	-	650	690	
Well C-11 ^(h)	2,000	3,230	-	-	-	-	-	-	-	-	-	-	
Well C-12 ^(h)	2,000	3,230	-	-	-	-	-	-	-	-	-	-	
S9 ^(h)	1,000	1,610	-	-	-	-	-	320	320	320	320	320	
Future Subtotal	37,200	60,060	5,680	7,590	7,070	9,180	11,580	12,970	14,000	14,920	15,570	17,020	
Total	51,470	83,090	12,980	14,890	15,200	17,310	19,710	20,270	21,300	22,220	22,870	23,350	

Notes:

- (a) The quantities of groundwater extracted by existing or future and recovered well capacity will vary depending on operating conditions. However, overall pumping remains within the groundwater basin yields per the 2020 SCV-GSA Water Budget Development Tech Memo (GSI 2020) and the updated Basin Yield Analysis (LSC & GSI 2009).
- (b) Dry-year production represents anticipated maximum dry year production. Schedule for recovered well capacity based on Groundwater Treatment Implementation Plan Technical Memorandum, Kennedy Jenks 2021 in Appendix M of the 2020 UWMP. 2023 through 2025 adjustments based on August 2022 engineering project schedule updates.
- (c) Existing Category includes all wells currently online and in use.
- (d) E Wells and Lost Canyon have not come below the RL so are not impacted wells but are anticipated to be connected into central treatment systems.

- (e) Future Category includes all wells restored from PFAS and Perchlorate water quality issues, and other future alluvial wells including those associated with development under the Newhall Ranch Specific Plan.
- (f) PFAS impacted well.
- (g) Perchlorate impacted well.
- (h) Future wells.
- (i) Permitted and Max. Annual Capacity for wells does not represent anticipated water supply provided by wells.

Sustainability

Until 2003, the long-term renewability of Alluvial groundwater was empirically determined from approximately 60 years of pumping and groundwater level records. Generally, those long-term observations included stability in groundwater levels and storage, with some dry-period fluctuations in the eastern part of the Basin. During this period, the total Alluvial pumpage ranged from a low of about 20,000 AFY to as high as about 43,000 AFY. Those empirical observations have since been complemented by the development and application of a numerical groundwater flow model, which has been used to simulate aquifer response to the planned operating ranges and distribution of pumping. The numerical groundwater flow model has also been used to analyze the control of perchlorate contaminant migration. The model was used to evaluate the likelihood of perchlorate migration to the then VWC wells, in particular Well Q2 and the wells in the VWC Pardee wellfield. The assessment of perchlorate migration also evaluated the sustainability and reliability of water supplies from the Alluvial aquifer. This analysis (LSCE, 2005) concluded that there was sufficient production capacity in the Alluvium to meet water demands in the case of VWC Well Q2 and/or the Pardee well field being temporarily taken out of service due to perchlorate impacts.

To examine the yield of the Alluvium, or more specifically the sustainability of the Alluvium on a renewable basis, the original groundwater flow model was used to examine the long-term projected response of the aquifer to pumping for municipal and agricultural uses in the 30,000 to 40,000 AFY range under average/normal and wet conditions, and in the 30,000 to 35,000 AFY range under locally dry conditions, documented in the 2005 basin yield analysis (2005 Basin Yield Analysis), prepared by CH2M Hill & LSCE, 2005. To examine the response of the entire aquifer system, the original model also incorporated pumping from the Saugus Formation in accordance with the normal (7,500 to 15,000 AFY) and dry year (15,000 to 35,000 AFY) operating plan for that aquifer. The model was run over a synthetic 78-year hydrologic period, which was selected from actual historical precipitation to examine a number of hydrologic conditions expected to affect both groundwater pumping and groundwater recharge and including projected impacts from climate change.

Simulated Alluvial Aquifer response to the range of hydrologic conditions and pumping stresses was essentially a long-term repeat of the historical conditions that have resulted from similar pumping over the last several decades. The resultant response included (1) generally constant groundwater levels in the middle to western portion of the Alluvium, and fluctuating groundwater levels in the eastern portion as a function of wet and dry hydrologic conditions, (2) variations in recharge that directly correlate with wet and dry hydrologic conditions and (3) no long-term decline in groundwater levels or storage. Consequently, the Alluvial Aquifer was considered in the 2005 UWMP to be a sustainable water supply source to meet the Alluvial portion of the operating plan for the groundwater Basin.

In 2008, partly in preparation for the 2010 UWMP and partly in response to concerns about events expected to impact the future reliability of supplemental water supply from the SWP, an updated analysis was undertaken to assess groundwater development potential and possible augmentation of the groundwater operating plan. In addition to extending the model's calibration, the updated analysis simulated the historical record of climate and incorporated SWP deliveries for those climatic conditions for an 86-year period from 1922 through 2007, in place of the original model's synthetic 78-year hydrologic

period that had been developed prior to the availability of combined climate and SWP deliveries since 1922. While the overall operating plan ranges in the updated basin yield analysis did not change from the original operating plan, prevailing land-use conditions and the specific distributions of pumping were found to produce the same kinds of resultant Alluvial groundwater conditions as concluded to be sustainable in 2005 – (1) no long-term declines in Alluvial groundwater levels and storage; (2) multi-year periods of locally declining, or locally increasing, groundwater levels in response to cycles of below-normal and above-normal precipitation and (3) short-term impacts on pumping capacities in eastern parts of the basin due to declining groundwater levels during dry periods, mitigable by short-term redistribution of pumping to wells located in the central and western portions of the Basin (reflected in pumping volumes included in this WSA and the 2020 UWMP) and by conformance with the dry-period reduction in Alluvial pumping in the operating plan (Table 3-2). Based on the results of the updated basin yield analysis (LSCE & GSI, 2009), the operating plan is considered to reflect ongoing sustainable groundwater supply rates. In the Alluvium, sustainability was found via explicit simulation of pumping in wet/normal years near the upper end of the operating plan range. In dry years, sustainability was found via explicit simulation of pumping throughout the dry-year operating plan range, with the additional consideration that some redistribution of municipal pumping (reflected in this WSA and the 2020 UWMP and experienced in the dry years of 2014 and 2015) be implemented to achieve pumping rates near the dry-period range.

The SCV-GSA's work on Basin sustainability for the GSP has advanced the technical understanding of basin conditions since the 2009 basin yield analysis and confirms the previous conclusion. A new groundwater flow model using the U.S Geological Survey software MODFLOW-USG was developed calibrated and peer reviewed. The MODFLOW-USG model improves the spatial resolution and employs more sophisticated methods of representing stream/aquifer interactions among other advancements over the previous model. A more thorough discussion is documented in Development of a Numerical Groundwater Flow Model for the Santa Clara River Valley East Groundwater Subbasin GSI September 22, 2020. Additionally, the GSP Water Budget Analysis reflects updated climate change assumptions provided by DWR. New GSP technical reports defining the extent and nature of groundwater dependent ecosystems informed potential future adjustments of pumping distributions throughout the Alluvial Aquifer and Saugus Formation when considering sustainability criteria including potential impacts on groundwater dependent ecosystems. Accordingly, the 2020 UWMP reflects adjusted pumping distributions that are reflected in this WSA's Table 3-4C.

On January 3, 2022, the GSP was adopted which reflects updated technical resources and analysis, and a robust public involvement and review process. The plan can be accessed at. <https://scvgsa.org/wp-content/uploads/2021/12/SCV-GSP-Sections-Combined-20211217.pdf>.

The plan reached the following conclusions relating to sustainability:

1. Chronic Lowering of Groundwater Levels – Alluvium and Saugus Formation pumping consistent with the basin operating plan does not result in chronic lowering of groundwater levels.
2. Reduction of Groundwater Storage - Alluvium and Saugus Formation pumping consistent with the basin operating plan does not result in long-term groundwater storage depletion.
3. Degraded Water Quality – Implementation of treatment for known contaminants support continued Alluvium and Saugus Formation groundwater use consistent with the operating plan.
4. Land Subsidence – An evaluation of the available information indicates there is no evidence of land subsidence occurring. The GSP does identify additional data collection needs to ensure land subsidence remains a non-issue while achieving the basin operation plan. The GSP incorporates active monitoring stations.

5. Depletion of Interconnected Surface Water/Groundwater Dependent Ecosystems – Existing riparian habitat along the Santa Clara River is considered by resource agencies as having very high value. The extent and quality of the habitat can vary significantly from year to year in response to very wet or dry conditions and demonstrates considerable resiliency. Certain aquatic habitats are critical for known protected species such as the Three Spined Unarmored Stickle Back. The GSP incorporates a process that avoids groundwater pumping related permanent loss of riparian habitat or the temporary loss of critical aquatic habitat. Active monitoring of groundwater levels will occur and when trigger levels (set at or above historical groundwater levels) are reached, an assessment of the cause would be conducted. If impacts are related to pumping, then responsive measures and/or projects would be implemented. These could include a reduction of groundwater pumping.
6. Seawater Intrusion – The significant distance of the Alluvial Aquifer and Saugus Formation from the ocean, as well as differences in elevation, do not allow for seawater intrusion into the upper basin.

Considering the results of the 2009 basin yield analysis and the results of the updated groundwater analysis performed by the SCV-GSA for its GSP which included the pumping distributions consistent with those shown in Table 3-4C, the basin can be sustainably operated without chronic lowering of groundwater levels or groundwater storage.

3.3.2.5 Saugus Formation

Based on historical operating experience and recent (2005 and 2009) groundwater modeling analysis, the Saugus Formation can supply water on a long-term sustainable basis in a normal range of 7,500 to 15,000 AFY. Intermittent increases to 25,000 to 35,000 AF in dry years have not been historically experienced operationally, however, investigations of the Saugus Formation, historical groundwater level monitoring data, and numerical modeling indicate that the Saugus Formation can be pumped sustainably at these higher rates in dry years, followed by reductions in pumping in wet to normal years. The dry-year increases, based on modeled projections, demonstrate that the 25,000 to 35,000 AFY is a small amount of the large groundwater storage in the Saugus Formation and these amounts can be pumped over a relatively short (dry) period. This would be followed by recharge (replenishment) of that storage during a subsequent normal-to-wet period when the Saugus pumping would be reduced to 7,500 to 15,000 AFY.

Adequacy of Supply

For municipal water supply with existing wells, SCV Water has a combined pumping capacity from active Saugus wells of nearly 16,200 gpm, which translates into a full-time Saugus Formation source capacity of about 26,120 AFY. Additionally, LACWWD 36 completed a Saugus Formation Well with a pumping capacity estimated at 2,000 gpm and an annual capacity of 3,220 AFY. Saugus Formation pumping capacity from all the existing active municipal supply wells is summarized in Table 3-5A, as well as restored, replacement, and planned new supply wells. The active wells include two Saugus Formation wells contaminated by perchlorate (Saugus 1 and 2), which were returned to service in 2010 with treatment facilities for use of the treated water for municipal supply under permit from the California Department of Public Health (DPH). The permit is now with DDW. The active wells also include the most recent replacement well, Well 207, in a non-impacted part of the basin. Also included in Table 3-5A is Well 201, which was impacted by the detection of perchlorate and removed from service in 2010. The well has been equipped with treatment facilities for perchlorate and was awaiting final DDW approval), however, a second treatment train is being designed for treatment of VOCs. Well 201 is anticipated to provide a total of 2,000

gpm of pumping capacity and is anticipated to return to service sometime in 2024. Similarly, Well 205, was taken out of service for perchlorate. Treatment for this facility is under the early stages of design and it is anticipated to return to service in 2024 as shown in Table 3-6.

To achieve full dry year production of 33,800 AFY six additional Saugus wells are planned. Two of these wells, Saugus 3 and 4, located behind Magic Mountain, have been designed and re-bid after consultation with DDW on the criteria for obtaining an operating permit as related to issues surrounding the proximity of abandoned oil wells. It is estimated that these wells should be available in 2025. The next wells anticipated to be available are Saugus 5 and 6, located in the Castaic Junction area. Sites have been secured for these wells and they are anticipated to be available in 2027. To accommodate the shifting of pumping patterns associated with treatment being added at Well 201 and Well 205 the GSP Water Budget Analysis concluded that two additional dry-year wells would be required to meet the Saugus Formation pumping objectives. These final two wells, Saugus 7 and Saugus 8, do not have specific sites. The GSP Water Budget Analysis assumed these wells would be located near the South Fork of the Santa Clara River in the vicinity of the existing well 12 and 13. These wells are anticipated to become available in 2030. Additional details on DDW permitting and associated timeline for Saugus wells are provided in Section 4.7.

In terms of adequacy and availability, the combined active (existing) Saugus groundwater source capacity of municipal wells of about 29,340 AFY is more than sufficient to meet the planned use of Saugus groundwater in normal years of 7,500 to 15,000 AFY. This existing active capacity is also more than sufficient to meet near-term dry year water demands, in combination with other sources. In order to supplement long term dry-year supplies, additional Saugus Formation wells are planned to be operational within the next ten years.

With the restored capacity of Wells 201 and 205 and the additional planned new Saugus Formation wells, the total dry year combined capacity will increase to about 54,680 AFY. As shown in Table 3-5C, this combined capacity is more than sufficient to meet the multiple dry year municipal production target of 33,880 AFY.

**TABLE 3-5A
MUNICIPAL GROUNDWATER SOURCE CAPACITY
EXISTING, FUTURE AND RECOVERED SAUGUS FORMATION WELLS^(a)**

Well	Permitted Capacity ⁽ⁱ⁾ (gpm)	Max. Annual Capacity ⁽ⁱ⁾ (AF)	GSP Water Budget Analysis ^{(b)(j)}	
			Normal Year (AF)	Dry Year (AF)
Existing Wells^(c)				
LACWWD36 ^(d)				
Palmer	2,000	3,230	500	1,250
SCV Water				
12 ⁽ⁱ⁾	2,500	3,230 ⁽ⁱ⁾	530	2,280
13	2,500	4,030	540	2,280
160	2,000	3,230	0	680
206	2,500	4,030	180	2,830
207	2,500	4,030	140	2,860
Saugus 1	1,100	1,770	1,450	1,450
Saugus 2	1,100	1,770	1,350	1,350
<i>SCV Water Subtotal</i>	<i>14,200</i>	<i>22,090</i>	<i>4,190</i>	<i>13,730</i>
<i>Existing Purveyor Subtotal</i>	<i>16,200</i>	<i>25,320</i>	<i>4,690</i>	<i>14,980</i>
Future^(f) and Recovered Wells				
201 ^(e)	2,000	3,230	2,420	2,900
205 ^(g)	2,700	4,360	2,610	2,920
Saugus 3 ^(h)	2,500	4,030	30	2,620
Saugus 4 ^(h)	2,500	4,030	30	2,620
Saugus 5 ^(h)	2,000	3,230	30	1,940
Saugus 6 ^(h)	2,000	3,230	30	1,940
Saugus 7 ^(h)	2,000	3,230	30	1,940
Saugus 8 ^(h)	2,000	3,230	30	1,940
<i>Future Subtotal</i>	<i>17,700</i>	<i>28,570</i>	<i>5,210</i>	<i>15,920</i>
Total Purveyors	33,900	53,890	9,900	33,800

Notes:

- (a) The quantities of groundwater extracted by existing or future and recovered well capacity will vary depending on operating conditions. However, overall pumping remains within the groundwater basin yields per the GSP (GSI 2022) and the updated Basin Yield Analysis (LSC & GSI 2009).
- (b) Production for Normal and Dry years represented in this table represent the period after all impacted wells (PFAS and Perchlorate impacts) are recovered. See Tables 3-5B and 3-5C for anticipated production from 2021-2030. Dry-year production represents anticipated maximum dry year production. Schedule for recovered well capacity based on Groundwater Treatment Implementation Plan Technical Memorandum, Kennedy Jenks 2021 in Appendix M of the 2020 UWMP.
- (c) Existing Category includes all wells currently online and in use.
- (d) LAWWD36 anticipated production for normal and dry years.
- (e) Well 201 is awaiting VOC treatment and DDW permitting, returning to service in 2024.
- (f) Future Category includes two wells restored from Perchlorate and VOC water quality issues, and other future Saugus wells.
- (g) Well 205 is impacted by Perchlorate and is expected to return to service in 2024.
- (h) Future wells, Saugus 3 & 4, are planned replacement wells, Saugus 5-8 are new Dry Year wells. The new dry-year wells would not typically be operated during average/normal years.
- (i) Permitted at 2,500 gpm but capacity was reduced to 2,000 gpm (3,230 AF) during last rehab
- (j) Permitted and Max. Annual Capacity for wells does not represent anticipated annual water supply provided by the wells. Anticipated water supply from the wells is shown in the GSP Water Budget Analysis columns.

**TABLE 3-5B
MUNICIPAL GROUNDWATER SOURCE CAPACITY
EXISTING, FUTURE AND RECOVERED SAUGUS FORMATION WELLS^(a)
NORMAL YEAR DETAIL (2021-2030)**

Well	Permit Capacity ⁽ⁱ⁾ (gpm)	Max. Capacity ⁽ⁱ⁾ (AFY)	Normal Year (AF) ^(b)										
			2021	2022	2023	2024	2025	2026	2027	2028	2029	2030	
Existing Wells^(c)													
LACWWD36^(d)													
Palmer	2,000	3,230	500	500	500	500	500	500	500	500	500	500	500
SCV Water													
12 ⁽ⁱ⁾	2,500	3,230 ⁽ⁱ⁾	2,220	2,220	2,220	1,800	1,500	530	530	530	530	530	530
13	2,500	4,030	2,280	2,280	0	1,200	1,500	540	540	540	540	540	540
160	2,000	3,230	-	-	-	-	-	-	-	-	-	-	-
201 ^(e)	2,000	3,230	-	-	-	2,580	2,580	2,480	2,420	2,420	2,420	2,420	2,420
206	2,500	4,030	2,830	2,830	2,830	2,020	2,020	200	200	200	200	200	180
207	2,500	4,030	2,860	2,860	2,860	2,040	2,040	180	180	180	180	180	140
Saugus 1	1,100	1,770	1,450	1,450	1,045	800	1,450	1,450	1,450	1,450	1,450	1,450	1,450
Saugus 2	1,100	1,770	1,350	1,350	1,000	1,500	1,350	1,350	1,350	1,350	1,350	1,350	1,350
SCV Water Subtotal	16,200	25,320	12,990	12,990	9,955	11,940	12,440	6,730	6,670	6,670	6,670	6,670	6,610
Existing Purveyor Subtotal	18,200	28,550	13,490	13,490	10,455	12,440	12,940	7,230	7,170	7,170	7,170	7,170	7,110
Future and Recovered Wells													
205 ^(g)	2,700	4,360	-	-	-	0	1,500	2,610	2,610	2,610	2,610	2,610	2,610
Saugus 3 ^(h)	2,500	4,030	-	-	-	-	750	30	30	30	30	30	30
Saugus 4 ^(h)	2,500	4,030	-	-	-	-	750	30	30	30	30	30	30
Saugus 5 ^(h)	2,000	3,230	-	-	-	-	-	-	30	30	30	30	30
Saugus 6 ^(h)	2,000	3,230	-	-	-	-	-	-	30	30	30	30	30
Saugus 7 ^(h)	2,000	3,230	-	-	-	-	-	-	-	-	-	-	30
Saugus 8 ^(h)	2,000	3,230	-	-	-	-	-	-	-	-	-	-	30
Future Subtotal	15,700	25,340	-	-	-	0	3,000	2,670	2,730	2,730	2,730	2,730	2,790
Total Purveyors⁽ⁱ⁾	33,900	53,890	13,490	13,490	10,455	12,440	15,940	9,900	9,900	9,900	9,900	9,900	9,900

Notes:

(a) The quantities of groundwater extracted by existing or future and recovered well capacity will vary depending on operating conditions. However, overall pumping remains within the groundwater basin yields per the 2020 SCV-GSA Water Budget Development Tech Memo (GSI 2020) and the updated Basin Yield Analysis (LSC & GSI 2009).

- (b) Schedule for recovered well capacity based on Groundwater Treatment Implementation Plan Technical Memorandum, Kennedy Jenks 2021 in Appendix M of the 2020 UWMP. 2022-2025 updates based on permitting and treatment project schedule changes as of August 2022.
- (c) Existing Category includes all wells currently online and in use.
- (d) LAWWD36 anticipated production for normal and dry years.
- (e) Well 201 could have been put online through 97-005 permitting process, however treatment plans were altered and Well 201 is now awaiting supplemental VOC treatment and DDW permitting. Anticipated return to service in 2024.
- (f) Future Category includes one well restored from Perchlorate water quality issues, and other future Saugus wells.
- (g) Well 205 is impacted by Perchlorate and is expected to return to service in 2024.
- (h) Future wells, Saugus 3 & 4, are planned replacement wells, Saugus 5-8 are new Dry Year wells. The new dry-year wells would not typically be operated during average/normal years.
- (i) Permitted at 2,500 gpm but capacity was reduced to 2,000 gpm (3,230 AF) during last rehab.
- (j) Permitted and Max. Annual Capacity for wells does not represent anticipated water supply provided by wells

**TABLE 3-5C
MUNICIPAL GROUNDWATER SOURCE CAPACITY
EXISTING, FUTURE AND RECOVERED SAUGUS FORMATION WELLS^(a)
DRY YEAR DETAIL (2021-2030)**

Well	Permit Capacity (gpm) ⁽ⁱ⁾	Max. Capacity (AFY) ⁽ⁱ⁾	Dry Year (AF) ^(b)										
			2021	2022	2023	2024	2025	2026	2027	2028	2029	2030	
Existing Wells^(c)													
LACWWD36^(d)													
Palmer	2,000	3,230	1,250	1,250	1,250	1,250	1,250	1,250	1,250	1,250	1,250	1,250	1,250
SCV Water													
12 ⁽ⁱ⁾	2,500	3,230 ⁽ⁱ⁾	2,280	2,280	2,280	1,800	1,500	2,280	2,280	2,280	2,280	2,280	2,280
13	2,500	4,030	2,280	2,280	0	1,200	1,500	2,280	2,280	2,280	2,280	2,280	2,280
160	2,000	3,230	680	680	680	680	680	680	680	680	680	680	680
201 ^(e)	2,000	3,230	-	-	-	2,900	2,900	2,900	2,900	2,900	2,900	2,900	2,900
206	2,500	4,030	2,830	2,830	2,830	2,830	2,830	2,830	2,830	2,830	2,830	2,830	2,830
207	2,500	4,030	2,860	2,860	2,860	2,860	2,860	2,860	2,860	2,860	2,860	2,860	2,860
Saugus 1	1,100	1,770	1,450	1,450	1,045	800	1,450	1,450	1,450	1,450	1,450	1,450	1,450
Saugus 2	1,100	1,770	1,350	1,350	1,000	1,500	1,350	1,350	1,350	1,350	1,350	1,350	1,350
SCV Water Subtotal	16,200	25,320	13,730	13,730	10,695	14,570	15,070	16,630	16,630	16,630	16,630	16,630	16,630
Existing Purveyor Subtotal	18,200	28,550	14,980	14,980	11,945	15,820	16,320	17,880	17,880	17,880	17,880	17,880	17,880
Future and Recovered Wells													
205 ^(g)	2,700	4,360	-	-	-	0	1,500	3,050	3,050	3,050	3,050	3,050	2,920
Saugus 3 ^(h)	2,500	4,030	-	-	-	-	3,020	3,020	2,620	2,620	2,620	2,620	2,620
Saugus 4 ^(h)	2,500	4,030	-	-	-	-	3,020	3,020	2,620	2,620	2,620	2,620	2,620
Saugus 5 ^(h)	2,000	3,230	-	-	-	-	-	-	2,420	2,420	2,420	2,420	1,940

Saugus 6 ^(h)	2,000	3,230	-	-	-	-	-	-	2,420	2,420	2,420	1,940
Saugus 7 ^(h)	2,000	3,230	-	-	-	-	-	-	-	-	-	1,940
Saugus 8 ^(h)	2,000	3,230	-	-	-	-	-	-	-	-	-	1,940
Future Subtotal	15,700	25,340	0	0	0	0	7,540	9,090	13,130	13,130	13,130	15,920
Total Purveyors⁽ⁱ⁾	33,900	53,890	14,980	14,980	11,945	15,820	23,860	26,970	31,010	31,010	31,010	33,800

Notes:

- (a) The quantities of groundwater extracted by existing or future and recovered well capacity will vary depending on operating conditions. However, overall pumping remains within the groundwater basin yields per the 2020 SCV-GSA Water Budget Development Tech Memo (GSI 2020) and the updated Basin Yield Analysis (LSC & GSI 2009).
- (b) Dry-year production represents anticipated maximum dry year production. Schedule for recovered well capacity based on Groundwater Treatment Implementation Plan Technical Memorandum, Kennedy Jenks 2021 in Appendix M of the 2020 UWMP. 2023-2025 updates based on permitting and treatment project schedule changes as of August 2022.
- (c) Existing Category includes all wells currently online and in use.
- (d) LAWWD36 anticipated production for normal and dry years.
- (e) Well 201 could have been put online through 97-005 permitting process, however treatment plans were altered and Well 201 is now awaiting supplemental VOC treatment and DDW permitting. Anticipated return to service in 2024.
- (f) Future Category includes one well restored from Perchlorate water quality issues, and other future Saugus wells.
- (g) Well 205 is impacted by Perchlorate and is expected to return to service in 2024.
- (h) Future wells, Saugus 3 & 4, are planned replacement wells, Saugus 5-8 are new Dry Year wells. The new dry-year wells would not typically be operated during average/normal years.
- (i) Permitted at 2,500 gpm but capacity was reduced to 2,000 gpm (3,230 AF) during last rehab.
- (j) Permitted and Max. Annual Capacity for wells does not represent anticipated water supply provided by wells

Sustainability

Until 2003, the long-term sustainability of Saugus Formation groundwater was empirically estimated from limited historical experience. Historically (and continuing to the present), pumping from the Saugus Formation has been fairly low in most years, with one four-year period of increased pumping up to about 15,000 AFY that had short-term water level impacts but produced no long-term depletion of the substantial groundwater storage in the Saugus Formation. Those empirical observations have now been complemented by the development and application of the numerical groundwater flow model. The numerical groundwater flow model has also been used to analyze the control of perchlorate contaminant migration on two separate occasions under selected pumping conditions. The first occasion resulted in the implementation of a plan to restore, with treatment, pumping capacity that was formerly inactivated due to perchlorate contamination detected in the Saugus 1 and Saugus 2 wells in the Basin. The second occasion utilized the numerical groundwater flow model to evaluate preferred plans to control the migration of perchlorate in the vicinity of Well 201. As discussed in Section 3, those restoration efforts have been undertaken and the restoration of that pumping is reflected in the Saugus Formation operating plan (Table 3-2) and pumping distribution (Table 3-5A).

To examine the yield of the Saugus Formation, or its sustainability on a renewable basis, the original groundwater flow model was used to examine long-term projected response to pumping from both the Alluvium and the Saugus Formation over the synthetic 78-year period of hydrologic conditions that incorporated alternating wet and dry periods as have historically occurred (CH2M Hill and LSCE, 2005). The model was based upon field investigations and historical data collected from numerous sources including annual reports prepared by LSCE and investigations of Saugus Formation and Alluvial aquifers by CH2M Hill and Richard C. Slade and Associates among others (CH2M Hill, 2004a, 2004b, 2005a; CH2M Hill & LSCE 2005; LSCE 2005; Slade & Associates 1986, 1988, 2002). The pumping simulated in the model was in accordance with the then-current operating plan for the Basin. For the Saugus Formation,

simulated pumping included the then-planned restoration of historic pumping from the wells impacted by perchlorate at that time (Saugus 1 and Saugus 2).

The originally simulated Saugus Formation response to the ranges of operating plan pumping under assumed recurrent historical hydrologic conditions was consistent with actual experience under smaller pumping rates: (1) short-term declines in groundwater levels and storage near pumped wells during dry-period pumping, (2) recovery of groundwater levels and storage after cessation of dry-period pumping and (3) no long-term decreases or depletion of groundwater levels or storage. The combination of actual experience with Saugus Formation recharge and pumping up to about 15,000 AFY, complemented by modeled projections of aquifer response that showed long-term utility of the Saugus Formation at 7,500 to 15,000 AFY in normal years and rapid recovery from higher pumping rates during intermittent dry periods, was the basis for concluding that the Saugus Formation could be considered a sustainable water supply source to meet the Saugus Formation portion of the operating plan for the groundwater Basin.

As discussed under Sustainability of the Alluvium above, an updated basin yield analysis was undertaken in 2008 to assess groundwater development potential and possible augmentation of the groundwater operating plan. After extended and updated model calibration and incorporation of extended historical records, the overall operating plan (Table 3-2) and specific distribution of Saugus Formation pumping were found to produce the same kinds of resultant Saugus Formation groundwater conditions as concluded to be sustainable in 2005 – (1) long-term stability of groundwater levels, with no sustained declines; (2) groundwater levels slightly below historic Saugus Formation levels, in response to greater long-term utilization of the Saugus and (3) maintenance of sufficiently high Saugus Formation groundwater levels to ensure achievement of planned individual pumping capacities (Table 3-5). Thus, the operating plan for the Saugus Formation, with fairly low pumping in wet/normal years and increased pumping through dry periods, is concluded to reflect sustainable groundwater supply rates.

The SCV-GSA's work on basin sustainability for the GSP has advanced the technical understanding of basin conditions since the 2009 basin yield analysis and confirms the previous conclusion. A new groundwater flow model using the U.S Geological Survey software MODFLOW-USG was developed calibrated and peer reviewed. The MODFLOW-USG model improves spatial resolution and employs more sophisticated methods of representing stream/aquifer interactions among other advancements over the previous model. A more thorough discussion is documented in Development of a Numerical Groundwater Flow Model for the Santa Clara River Valley East Groundwater Subbasin (GSI 2020). Additionally, the GSP Water Budget Analysis reflects updated climate change assumptions provided by DWR. New GSP technical reports defining the extent and nature of groundwater dependent ecosystems informed potential future adjustments of pumping distributions throughout the Alluvial Aquifer and Saugus Formation when considering likely sustainability criteria and potential impacts on groundwater dependent ecosystems. Accordingly, the 2020 UWMP reflects adjusted pumping distributions that are reflected in this WSA's Table 3-5A.

On January 3, 2022, the SCV GSP adopted the GSP which reflected updated technical resources and analysis, and a robust public involvement and review process. The plan can be accessed at: <https://scvgsa.org/wp-content/uploads/2022/02/Santa-Clara-River-Valley-East-Groundwater-Subbasin-GSP.pdf>

The plan reached the following conclusions relating to sustainability:

1. Chronic Lowering of Groundwater Levels – Alluvium and Saugus Formation pumping consistent with the basin operating plan does not result in chronic lowering of groundwater levels.

2. Reduction of Groundwater Storage - Alluvium and Saugus Formation pumping consistent with the basin operating plan does not result in long-term groundwater storage depletion.
3. Degraded Water Quality – Implementation of treatment for known contaminants support continued Alluvium and Saugus Formation pumping consistent with the operating plan.
4. Land Subsidence – An evaluation of the available information indicates there is no evidence of land subsidence occurring. The GSP does identify additional data collection needs to ensure land subsidence remains a non-issue while achieving the basin operating plan. The GSP incorporates active monitoring stations.
5. Depletion of Interconnected Surface Water/Groundwater Dependent Ecosystems – Existing riparian habitat along the Santa Clara River is considered by resource agencies as having very high value. The extent and quality of the habitat can vary significantly from year to year in response to very wet or dry conditions and demonstrates considerable resiliency. Certain aquatic habitats are critical for known protected species such as the Three Spined Unarmored Stickle Back. The GSP incorporates a process that avoids groundwater pumping related to permanent loss of riparian habitat or the temporary loss of critical aquatic habitat. Active monitoring of groundwater levels will occur and when trigger levels (set at or above historical groundwater levels) are reached, an assessment of the cause would be conducted. If impacts are related to pumping, then responsive measures and/or projects would be implemented. These could include a reduction of groundwater pumping
6. Sea Water Intrusion – The proximity of the Alluvial Aquifer and Saugus Formation to the ocean as well as differences in elevation, do not allow for seawater intrusion into the upper basin.

The results of the 2009 basin yield analysis and the results of the updated groundwater analysis performed by the SCV-GSA for the GSP, which included pumping distributions consistent with those shown in Table 3-5A, show that the basin can be sustainably operated without chronic lowering of groundwater levels or groundwater storage.

Thus, the operating plan for the Saugus Formation, with fairly low pumping in wet/normal years and increased pumping through dry periods, is concluded to reflect sustainable groundwater supply rates.

3.3.3 Existing and Planned Groundwater Pumping

3.3.3.1 Impacted Well Capacity

As discussed in Section 6, USEPA recently implemented a new lifetime health advisory level of 70 parts per trillion (or 70 nanogram per liter (ng/l)) for polyfluoroalkyl substances (PFAS). In August of 2019, DDW set notification level (NL) and response levels for various PFAS constituents. SCV Water wells were tested and as of February 2020, over 60% of Alluvium wells exceeded the NL or RL resulting in 18 wells being taken out of service. Treatment for three of these wells (N-Wells) has been installed and is now operational. Design is underway for treatment of two additional wells, Honby and Santa Clara, that are scheduled to be returning to service by 2023. Preliminary design for an additional 6 wells is under way and these are anticipated to be returning to service between 2024 and 2025. The remaining wells are anticipated to have treatment installed by 2030. A feasibility assessment and schedule for completion of these wells are shown in the April 2021 Technical Memorandum, Groundwater Treatment Implementation Plan (Kennedy Jenks 2021). The Capital Improvement Section of SCV Water’s FY 2021/222 and FY2022/23 Biennial Budget provides near term funding treatment for PFAS impacted alluvial wells.

As discussed in Section 6.2.1 of the 2020 UWMP and incorporated herein, certain wells in the Basin were impacted by perchlorate contamination and thus represented a temporary loss of well capacity within SCV Water's service area. Six wells were initially taken out of service upon the detection of perchlorate including four Saugus wells and two Alluvial wells. All have either been (1) abandoned and replaced, (2) returned to service with the addition of treatment facilities that allow the wells to be used for municipal Water supply as part of the overall water supply systems permitted by DDW, or (3) will be replaced under an existing perchlorate litigation settlement agreement (see Section 4). The restored wells (two Saugus wells and one Alluvial well), one Saugus well which is currently being restored, and the replacement wells (one Saugus and one Alluvial well), which collectively restore much of the temporarily lost well capacity, are now included as parts of the municipal groundwater source capacities. Additional wells will be drilled to fully restore the impacted well capacity, thus restoring the operational flexibility that existed prior to perchlorate contamination being discovered.

In August 2010, Well 201, located downgradient from the Whittaker-Bermite site and downgradient from the initially impacted Saugus 1 and Saugus 2 wells and well 157 had detections of perchlorate and was removed from service. Treatment facilities were constructed, are operational, and are now awaiting final DDW approval to be returned to potable drinking water service, similar to the Saugus 1 and Saugus 2 wells. Well 201 is anticipated to provide a total of 2,000 gpm of pumping capacity (for a dry-year production capacity of 2,900 AFY) and is shown in Table 3-5A. Similarly, Well 205, was taken out of service for perchlorate. Treatment for this facility is under the early stages of design and it is anticipated to return to service in 2024 as shown in Tables 3-5B and 3-5C. Additional details on DDW permitting and associated timeline for Saugus wells 201 and 205 are provided in Section 4.7.

To achieve full dry-year production of 33,800 AFY six additional Saugus wells are planned. Two of these wells Saugus 3 and 4, located west of Magic Mountain, have been designed and are being rebid. As indicated above, this delay was related to issues surrounding the proximity to abandoned oil wells and discussion with DDW resulted in an approach that should facilitate DDW issuing an operating permit. It is estimated that these wells should be available in 2025. The next wells anticipated to be available are Saugus 5 and 6, located in the Castaic Junction area. Sites for these wells have been secured and the wells are anticipated to be available in 2027. The final two wells, Saugus 7 and 8, do not have specific sites. The GSP Water Budget Analysis (GSI 2020a) assumed these wells would be located near the South Fork of the Santa Clara River in the vicinity of the existing well 12 and 13. These wells are anticipated to become available in 2030. Additional details on DDW permitting and associated timeline for Saugus wells are provided in Section 4.7.

3.3.3.2 Alluvium

In terms of adequacy and availability, the current Alluvial Aquifer groundwater pumping capacity is constrained, however the current reductions in supply are being met by other sources of supply such as imported SWP water or banked water supplies. The schedule for recovery of this supply is shown in Table 3-4B for normal years and Table 3-4C for dry years. When well capacity is recovered in 2030 and other future wells are in service in 2035 the combined Alluvial Aquifer groundwater source municipal well capacity of approximately 83,090 AFY will be sufficient to meet anticipated demands. The higher cumulative pumping capacities are for operational reasons (i.e., to meet daily and other fluctuations from average day to maximum day and peak hour system demands).

Table 3-4B and 3-4C include future and recovered Alluvial Aquifer supplies. These planned supplies do not increase the total quantity of water being withdrawn from the Alluvial Aquifer but represent anticipated or potential shifts in pumping involving different or new wells.

For example, as shown on Table 3-4, planned Alluvial Aquifer supplies assume a reduction of Newhall Land agricultural uses and a corresponding increase in SCV Water Alluvial water use for the Newhall Ranch Specific Plan area. Total purveyor and non-purveyor supplies remain consistent with the operating plan shown on Table 3-2. Based on existing information the conclusion of the analysis is that total Alluvial Aquifer pumping is sustainable. However, should droughts extend for periods longer than those shown in the historical record, potential exists for future curtailments.

3.3.3.3 Saugus Formation

In terms of adequacy and availability, the combined active Saugus groundwater source municipal well capacity of 26,120 AFY (29,340 including LACWD36 well) is more than sufficient to meet the planned use of Saugus groundwater in normal years of 7,500 to 15,000 AFY (Table 3-5A). Near term dry-year supplies will be augmented once Well 205 is restored to service by 2024 utilizing treatment technologies currently being used in the Santa Clarita Valley. In order to accommodate the longer-term demands, current GSP Water Budget Analysis indicates six additional wells will be required. Two of these wells have been designed and await permitting, sites for two additional wells have been secured and the final two wells need to be sited. These additional Saugus wells would provide for meeting the planned maximum purveyor use of 33,800 AFY of Saugus groundwater during a multiple-dry year period. That amount combined with non-purveyor pumping of 1,200 AFY is at the maximum of 35,000 AFY consistent with operating plan shown on Table 3-2. The conclusion of the analysis is that the Saugus operating plan is sustainable. However, associated with the implementation of the GSP, the potential exists for some future curtailment of pumping during extreme long-term drought events over the upcoming twenty years. Table 3-6, Table 3-7, and Table 3-8 include planned Saugus Formation supplies.

3.3.3.4 Summary

Overall, the total municipal supply in the 2020 UWMP, incorporated herein, includes a groundwater component that is, in turn, part of the overall groundwater supply of the Santa Clarita Valley. As such, the municipal groundwater supply recognizes the existing and projected future uses of groundwater by overlying interests in the Valley, such that the combination of municipal and all other groundwater pumping, remains within the groundwater operating plan (Table 3-2) that has been analyzed for sustainability.

**TABLE 3-6
AVERAGE/NORMAL YEAR EXISTING AND PLANNED GROUNDWATER USAGE (AF)^(a)**

Alluvium Supplies	2025	2030	2035	2040	2045	2050
Purveyors Existing	8,900	8,180	7,300	7,300	7,300	7,300
Purveyors Future and Recovered ^(b)	10,340	19,870	23,490	23,490	23,490	23,490
<i>Purveyors Total</i>	<i>19,240</i>	<i>28,050</i>	<i>30,790</i>	<i>30,790</i>	<i>30,790</i>	<i>30,790</i>
Non-Purveyors (Agricultural & Other) ^(c)	11,540	9,150	6,410	6,410	6,410	6,410
Total Alluvium Production	30,780	37,200	37,200	37,200	37,200	37,200
<i>Alluvial Operating Plan Range for Average/Normal Year (30,000-40,000)</i>						
Saugus Formation Supplies	2025	2030	2035	2040	2045	2050
Purveyors Existing	14,440	7,110	7,110	7,110	7,110	7,110
Purveyors Future and Recovered ^(d)	3,010	2,790	2,790	2,790	2,790	2,790
<i>Purveyors Total</i>	<i>17,450</i>	<i>9,900</i>	<i>9,900</i>	<i>9,900</i>	<i>9,900</i>	<i>9,900</i>
Non purveyors ^(e)	1,200	1,200	1,200	1,200	1,200	1,200
Total Saugus^(f)	18,650	11,100	11,100	11,100	11,100	11,100
<i>Saugus Operating Plan Range for Average/Normal Year (7,500-15,000)</i>						

Notes:

- (a) The quantities of groundwater extracted by existing or future and recovered well capacity will vary depending on operating conditions. However, overall pumping remains within the groundwater basin yields per the 2020 SCV-GSA Water Budget Development Tech Memo (GSI 2020) and the updated Basin Yield Analysis (LSC & GSI 2009).
- (b) These values account for recovery of alluvial PFAS and Perchlorate impacted wells along with additional pumping to supply Newhall Ranch Specific Plan.
- (c) Alluvial non purveyor pumping includes Five Point (Newhall Ranch Agriculture), Pitches Detention Center, and Small Private Domestic pumping and irrigation at Sand Canyon Country Club. Decline in pumping rates incorporate reduced pumping by Five Point of 7,038 AFY for Newhall Ranch Specific Plan.
- (d) This includes Saugus Perchlorate impacted wells 201 and 205, two replacement wells (Saugus 3 & 4), and up to four new wells (Saugus 5-8) planned to provide additional dry-year supply. The new dry-year wells would not typically be operated during average/normal years.
- (e) This includes private irrigation pumping from Valencia Country Club and Vista Valencia Golf Course, as well as projected Whittaker-Bermite pumping for perchlorate treatment, assumed constant.
- (f) Higher total Saugus Production from 2021 to 2026 reflect temporary increase in purveyor production to mitigate for lost Alluvial pumping capacity due to PFAS impacted wells.

**TABLE 3-7
SINGLE DRY YEAR EXISTING AND PLANNED GROUNDWATER USAGE (AF)^(a)**

Alluvium Supplies	2025	2030	2035	2040	2045	2050
Purveyors Existing	7,300	6,330	5,590	5,590	5,590	5,590
Purveyors Future and Recovered ^(b)	9,030	17,020	20,500	20,500	20,500	20,500
<i>Purveyors Total</i>	<i>16,330</i>	<i>23,350</i>	<i>26,090</i>	<i>26,090</i>	<i>26,090</i>	<i>26,090</i>
Non-Purveyors (Agricultural & Other) ^(c)	11,540	9,150	6,410	6,410	6,410	6,410
Total Alluvium Production	27,870	32,500	32,500	32,500	32,500	32,500
<i>Alluvial Operating Plan Range for Single Dry Year (30,000-35,000)</i>						
Saugus Formation Supplies	2025	2030	2035	2040	2045	2050
Purveyors Existing	17,880	17,880	17,880	17,880	17,880	17,880
Purveyors Future and Recovered ^(d)	9,090	15,920	15,920	15,920	15,920	15,920
<i>Purveyors Total</i>	<i>26,970</i>	<i>33,800</i>	<i>33,800</i>	<i>33,800</i>	<i>33,800</i>	<i>33,800</i>
Non purveyors ^(e)	1,200	1,200	1,200	1,200	1,200	1,200
Total Saugus	28,170	35,000	35,000	35,000	35,000	35,000
<i>Saugus Operating Plan Range for Single Dry Year (21,000-35,000)</i>						

Notes:

- (a) The quantities of groundwater extracted by existing or future and recovered well capacity will vary depending on operating conditions. However, overall pumping remains within the groundwater basin yields per the 2020 SCV-GSA Water Budget Development Tech Memo (GSI 2020) and the updated Basin Yield Analysis (LSC & GSI 2009).
- (b) These values account for recovery of alluvial PFAS and Perchlorate impacted wells along with additional pumping to supply Newhall Ranch Specific Plan.
- (c) Alluvial non purveyor pumping includes Five Point (Newhall Ranch Agriculture), Pitches Detention Center, and Small Private Domestic pumping and irrigation at Sand Canyon Country Club. Decline in pumping rates incorporate reduced pumping by Five Point of 7,038 AFY for Newhall Ranch Specific Plan.
- (d) This includes Saugus Perchlorate impacted well 205, two replacement wells (Saugus 3 & 4), and up to four new wells (Saugus 5-8) planned to provide additional dry-year supply. The new dry-year wells would not typically be operated during average/normal years.
- (e) This includes private irrigation pumping from Valencia Country Club and Vista Valencia Golf Course, as well as projected Whittaker-Bermite pumping for perchlorate treatment, assumed constant.

**TABLE 3-8
MULTIPLE DRY YEAR (5-YEAR) EXISTING AND PLANNED GROUNDWATER USAGE (AF)^(a)**

Alluvium Supplies	2025	2030	2035	2040	2045	2050
Purveyors Existing	7,300	6,330	5,890	5,590	5,590	5,590
Purveyors Future and Recovered ^(b)	11,930	16,310	19,900	20,500	20,500	20,500
<i>Purveyors Total</i>	19,230	22,640	25,790	26,090	26,090	26,090
Non-Purveyors (Agricultural & Other) ^(c)	11,490	9,190	6,710	6,410	6,410	6,410
Total Alluvium Production	30,720	31,830	32,500	32,500	32,500	32,500
<i>Alluvial Operating Plan Range for Multiple Dry Year (30,000-35,000)</i>						
Saugus Formation Supplies	2025	2030	2035	2040	2045	2050
Purveyors Existing	17,880	17,610	17,610	17,610	17,610	17,610
Purveyors Future and Recovered ^(d)	5,750	8,020	8,020	8,020	8,020	8,020
<i>Purveyors Total</i>	23,630	25,630	25,630	25,630	25,630	25,630
Non purveyors ^(e)	1,200	1,200	1,200	1,200	1,200	1,200
Total Saugus	24,830	26,830	26,830	26,830	26,830	26,830
<i>Saugus Operating Plan Range for Multiple Dry Year (21,000-35,000)</i>						

Notes:

- (a) The quantities of groundwater extracted by existing or future and recovered well capacity will vary depending on operating conditions. However, overall pumping remains within the groundwater basin yields per the 2020 SCV-GSA Water Budget Development Tech Memo (GSI 2020) and the updated Basin Yield Analysis (LSC & GSI 2009).
- (b) These values account for recovery of alluvial PFAS and Perchlorate impacted wells along with additional pumping to supply Newhall Ranch Specific Plan.
- (c) Alluvial non purveyor pumping includes Five Point (Newhall Ranch Agriculture), Pitches Detention Center, and Small Private Domestic pumping and irrigation at Sand Canyon Country Club. Decline in pumping rates incorporate reduced pumping by Five Point of 7,038 AFY for Newhall Ranch Specific Plan.
- (d) This includes Saugus Perchlorate impacted well 205, two replacement wells (Saugus 3 & 4), and up to four new wells (Saugus 5-8) planned to provide additional dry-year supply. The new dry-year wells would not typically be operated during average/normal years.
- (e) This includes private irrigation pumping from Valencia Country Club and Vista Valencia Golf Course, as well as projected Whittaker-Bermite pumping for perchlorate treatment, assumed constant.

3.4 Transfers and Exchanges

An opportunity available to SCV Water to increase water supplies is to participate in voluntary Water transfer programs. Since the drought of 1987-1992, the concept of water transfer has evolved into a viable supplemental source to improve supply reliability. The initial concept for water transfers was codified into law in 1986 when the California Legislature adopted the “Katz” Law (California Water Code, Sections 1810-1814) and the Costa-Isenberg Water Transfer Law of 1986 (California Water Code, Sections 470, 475, 480-483). These laws help define parameters for water transfers and set up a variety of approaches through which water or water rights can be transferred among individuals or agencies.

Up to 27 million AF of water are delivered for agricultural use every year. Over half of this water use is in the Central Valley, and much of it is delivered by, or adjacent to, SWP and CVP conveyance facilities. This proximity to existing water conveyance facilities could allow for the voluntary transfer of water to many urban areas, including SCV Water, via the SWP. Such water transfers can involve water sales, conjunctive use and groundwater substitution and water sharing. They usually occur as a form of spot, option, or core transfers agreements. The costs of a water transfer would vary depending on the type, term, and location of the transfer.

One of the most important aspects of any resource planning process is flexibility. A flexible strategy minimizes unnecessary or redundant investments (or stranded costs). The voluntary transfer of water between willing sellers and buyers can be an effective means of achieving flexibility. However, not all water transfers have the same effectiveness in meeting resource needs. Through the resource planning process and ultimate implementation, several different types of Water transfers could be undertaken.

3.4.1 Core Transfers

Core transfers are agreements to purchase a defined quantity of water every year. These transfers have the benefit of more certainty in costs and supply, but in some years can be surplus to imported water (available in most years) that is already paid for.

3.4.2 Spot Market Transfers

Spot market transfers involve water purchased only during a time of need (usually a drought). Payments for these transfers occur only when water is actually requested and delivered, but there is usually greater uncertainty in terms of costs and availability of supply. Examples of such transfers were the Drought Water Banks of 1991, 1992 and 1994 and DWR Dry Year Water Purchase Programs in 2001 through 2004 and 2008 along with transfers between willing sellers and buyers during the current drought period. In 2021, the Dry Year Water Purchase Program provided approximately 200 AF. An additional risk of spot market transfers is that the purchases may be subject to institutional limits or restricted access (e.g., requiring the purchasing agency to institute rationing before it is eligible to participate in the program).

3.4.3 Option Contracts

Option contracts are agreements that specify the amount of water needed and the frequency or probability that the supply will be called upon (an option). Typically, a relatively low up-front option payment is required and, if the option is actually called upon, a subsequent payment would be made for the amount called. These transfers have the best characteristics of both core and spot transfers. With option contracts, the potential for redundant supply is minimized, as are the risks associated with cost and supply availability.

SCV Water has entered into one such transfer, for Yuba Accord water, as discussed previously. SCV Water and a number of other entities entered into the Yuba Accord Agreement, which allows for the purchase of water from the Yuba County Water Agency through DWR. Under the agreement, an estimated average of up to 1,000 AFY of Water (after losses) is available to SCV Water in dry years, through 2025. Under certain hydrologic conditions, additional water may be available to SCV Water under this program. In 2014, 2020, and 2021, SCV Water received approximately 1,900 AF from this source (see Table 5-1).

3.4.4 Future Market Transfers

The most viable types of water transfers are core and option transfers and, as such, are a part of SCV Water's long-term strategy.

3.4.5 Water Exchanges

In addition to water transfers, short-term water exchanges may also serve as a means to enhance water reliability.

In 2011 SCV Water entered into two unbalanced exchange agreements to enhance the management of its water supplies. SCV Water executed a Two-for-One Water Exchange Program with RRBWSD, whereby SCV Water can recover one acre-foot of water for each two acre-feet SCV Water delivered to RRBWSD (less losses). SCV Water delivered 15,602 AF to the program in 2011, delivered another 3,969 AF in 2012 and, after program losses, had about 9,500 AF of recoverable water. The term for this agreement was ten years. In 2020, 9,500 AF of water was withdrawn from this exchange account, completing the execution of this agreement.

SCV Water also entered into a Two-for-One Water Exchange Program with the West Kern Water District (WKWD) in Kern County and SCV Water delivered 5,000 AF in 2011, resulting in a recoverable total of 2,500 AF. The term of the agreement was ten years. In 2014, 2,000 AF of water was withdrawn from this exchange program leaving a balance of 500 AF. In 2020, the remaining balance of 500 AF of water was withdrawn, completing the execution of this agreement.

In 2014, SCV Water entered into an unbalanced exchange agreement to enhance the management of its water supplies. SCV Water executed a Two-for-One Water Exchange Program with the NLF, whereby SCV Water could recover one acre-foot of water for every two acre-feet SCV Water delivered to NLF's Semitropic Water Storage District Banking Program. SCV Water transferred 10,000 AF of water to the program in 2014 and recovered 4,950 AF in 2014, fully executing the exchange. Additional details on the Semitropic Banking Program are provided below.

In 2016, SCV Water entered into an unbalanced exchange agreement to enhance the management of its water supplies. SCV Water executed a Two-for-One Water Exchange Program with the Central Coast Water Agency (CCWA) on behalf of the Santa Barbara County Flood Control and Water Conservation District (Santa Barbara), whereby SCV Water could recover one acre-foot of water for every two acre-feet SCV Water delivered to CCWA. SCV Water delivered 1,500 AF to the program in 2016 and recovered 750 AF in 2019, fully executing the exchange.

In 2019, SCV Water entered into three separate unbalanced exchange agreements to enhance the management of its water supplies. First, SCV Water executed a Two-for-One Water Exchange Program with RRBWSD whereby SCV Water could recover one acre-foot of water for every two acre-feet SCV Water delivered to RRBWSD (less losses). SCV Water delivered 11,000 AF to the program in 2019 and recovered 5,500 AF in 2020, fully executing the exchange.

In 2019, SCV Water also executed a Two-for-One Water Exchange Program with Antelope Valley-East Kern Water Agency (AVEK), whereby SCV Water could recover one acre-foot of water for every two acre-feet SCV Water delivered to AVEK. SCV Water delivered 7,500 AF to the program in 2019 and has 3,750 AF of recoverable water. In 2020, 1,406 AF of Water was withdrawn from this exchange program leaving a balance of 2,344 AF. Recovery of the balance is limited to years where the SWP allocation is at least 30%. The term for this agreement is for ten years.

In 2019, SCV Water also executed a Two-for-One Water Exchange Program with UWCD, whereby SCV Water could recover one acre-foot of water for every two acre-feet SCV Water delivered to UWCD. SCV Water delivered 1,000 AF to the program in 2019 and has 500 AF of recoverable water. Recovery of the balance is limited to years where the SWP allocation is at least 30%. The term for this agreement is for ten years.

3.5 Groundwater Banking Programs

With the development of conjunctive use and groundwater banking, the water supply reliability for SCV Water has improved significantly. Conjunctive use is the coordinated operation of multiple water supplies to achieve improved supply reliability. Most conjunctive use concepts are based on storing surface supplies in groundwater basins in times of surplus for withdrawal and use during dry periods and drought when surface water supplies would likely be reduced.

Groundwater banking programs involve storing available SWP surface water supplies during wet years in groundwater basins in, for example, the San Joaquin Valley. Water would be stored either directly by surface spreading or injection, or indirectly by supplying surface water to farmers for their use in lieu of their intended groundwater pumping. During water shortages, the stored water could be pumped out and conveyed through the California Aqueduct to SCV Water as the banking partner or used by the farmers in exchange for their surface water allocations, which would be delivered to SCV Water as the banking partner through the California Aqueduct.

SCV Water is a partner in two existing groundwater banking programs, the Semitropic Banking Program and RRBWSD Banking Program, respectively. Newhall Land is also a partner in the Semitropic Banking Program, described below. In addition, SCV Water has updated its plan to enhance its overall supply reliability, including the need for additional banking programs.

3.5.1 Semitropic Banking Program

Semitropic Water Storage District (Semitropic) provides SWP Water to farmers for irrigation. Semitropic is located in the San Joaquin Valley in the northern part of Kern County immediately east of the California Aqueduct. Using its available groundwater storage capacity (approximately 1.65 million AF), Semitropic has developed a groundwater banking program, which takes available SWP supplies in wet years and returns the water in dry years. As part of this dry-year return, Semitropic can either leave its SWP Water in the Aqueduct for delivery to a banking partner and increase its groundwater production for its farmers, or Semitropic can pump groundwater that can be pumped into a Semitropic canal and, through reverse pumping plants, be delivered to the California Aqueduct. Semitropic's original banking program currently has six long-term first priority banking partners: the Metropolitan Water District of Southern California (Metropolitan), Santa Clara Valley Water District, Alameda County Water District, Alameda County Flood Control and Water Conservation District Zone 7, Newhall Land and Farming, and San Diego County Water Authority. The total amount of storage capacity under contract in the original banking program is 1 million AF, with approximately 700,000 AF currently in storage. Under its original program, Semitropic can pump back a maximum of 90,000 AFY of water into the California Aqueduct.

Semitropic has recently expanded its groundwater banking program to incorporate its Stored Water Recovery Unit (SWRU). This supplemental program includes an additional storage capacity of 650,000 AF and an expansion of pumpback recovery capacity by 200,000 AFY. That pumpback capacity includes well connections and conveyance facility improvements to increase the existing Semitropic pumpback capacity to the California Aqueduct by an additional 50,000 AFY, and the future development of a new well field with approximately 65 wells along with new collection and transmission facilities to convey an additional 150,000 AFY to the California Aqueduct. Participants in the SWRU include Poso Creek Water Company, San Diego County Water Authority, City of Tracy, Homer LLC, Harris Farms, Shows Family Farms, Lazy Dog Orchard, and SCV Water.

In 2002, SCV Water entered into a temporary storage agreement with Semitropic and stored an available portion of its Table A supply (24,000 AF) in an account in Semitropic's program. In 2004, 32,522 AF of SCV Water's available 2003 Table A supply was stored in a second temporary Semitropic account. In accordance with the terms of SCV Water's storage agreements with Semitropic, 90 percent of the banked amount, or a total of 50,870 AF, was recoverable through 2013 to meet SCV Water demands when needed. SCV Water executed an amendment for a ten-year extension of each banking agreement with Semitropic in April 2010. After storage withdrawals in 2009, 2010, and 2014 (and with 5,000 AF given to Newhall Land in consideration for SCV Water's use of Newhall Land's first priority extraction capacity), the storage balance available to SCV Water was 35,970 AF.

In 2015 SCV Water entered into an agreement with Semitropic to participate in the SWRU. Under this agreement, the two short-term accounts containing 35,970 AF were transferred into this new program. Under the SWRU agreement, SCV Water can store and recover additional Water within a 15,000 AF storage account. SCV Water increased storage in the SWRU by 4,806 AF in 2017, and 4,502 AF in 2019, and recovered 5,000 AF in 2020, leaving the total storage available at 40,278 AF. The term of the Semitropic Banking Program extends through 2035 with the option of two 10-year renewals. SCV Water may withdraw up to 5,000 AFY from its account.

Current operational planning includes use of the water stored in Semitropic for dry-year supply. Accordingly, it is reflected in the available supplies delineated in this section and in the Annual Reports prepared for SCV Water. It is also reflected as contributing only to dry-year supply reliability in Section 7, through 2045.

3.5.2 Rosedale-Rio Bravo Banking Program

Also located in Kern County, immediately adjacent to the Kern Water Bank, RRBWSD has developed a Water Banking and Exchange Program. SCV Water has entered into a long-term agreement with RRBWSD with a total storage capacity of 100,000 AF. Between 2005 and 2012 SCV Water delivered sufficient water from the SWP and other supplies to fill its 100,000 AF account. SCV Water began storing water in this program in 2005 and stored water in 2005, 2006, 2007, 2010, 2011, and 2012. In 2012, the maximum storage capacity of 100,000 AF was reached. Withdrawals from the water bank occurred in 2014, 2015 and 2020. Storage into the water bank occurred in 2016 leaving storage at 98,800 AF currently available for withdrawal.

SCV Water's existing firm withdrawal capacity in this program is 10,000 AFY. To enhance dry-year recovery capacity, in 2015 SCV Water in cooperation with RRBWSD and Irvine Ranch Water District initiated construction of additional facilities that were completed in 2019. These facilities became available in 2020 and increased the firm extraction capacity for SCV Water to 10,000 AFY. In addition, SCV Water has the right under the contract to develop four additional wells which would bring the firm recovery capacity to 20,000 AFY. This additional capacity is anticipated to be available by 2030. In addition to existing firm recovery capacity, in moderately dry years Rosedale is required to use other available recovery capacity to meet its recovery obligations under the banking agreement, up to 20,000 AFY. This occurred in 2021 when RRBWSD was able to recover a total of 20,000 AF of SCV Water's banked supply.

This project is a water management program to improve the reliability of SCV Water's existing dry-year supplies. It is not an annual supply that could support growth. Accordingly, it is reflected in the available supplies delineated in this section and it is also reflected as contributing only to dry-year supply reliability.

3.5.3 Semitropic Banking Program – Newhall Land

As mentioned above, one of Semitropic’s long-term groundwater banking partners is Newhall Land (now owned by Five Point). In its agreement with Semitropic, Newhall Land has available to it a pump-back capacity of 4,950 AFY and a total storage capacity of 55,000 AF. At the end of 2020, Newhall Land had a storage balance of approximately 38,000 AF. This storage volume is primarily the result of Newhall Land storing its annual allotment of Nickel Water in the program as well as 5,000 AF of exchange water provided by SCV Water.

Newhall Land entered into this groundwater banking program in anticipation of the development of Newhall Ranch. It provides a supply that is committed by Newhall Land under the Newhall Ranch Specific Plan to make up shortfalls in water supply for Newhall Ranch should such shortfall be shown to exist. Under its agreement with Semitropic, Newhall Land may transfer its rights to this program to SCV Water (as the successor to CLWA). In this WSA and in the 2020 UWMP, it is assumed for planning purposes construction of the Newhall Ranch Specific Plan will be completed by 2035 and that Newhall Land’s rights in this banking program will be transferred to SCV Water at that time. Based on previous cooperation between CLWA and Newhall Land in 2009 and 2014, when Newhall Land effectively made its withdrawal capacity available to CLWA, it is likely that this practice would continue and SCV Water could access additional water from its Semitropic account using Newhall Land’s firm extraction capacity. However, as no such contract to accomplish this is currently in place a conservative assumption has been made in the 2020 UWMP and this WSA that supplies associated with this source will not be available prior to 2035 when SCV Water is presumed to control this program.

3.5.4 Other Opportunities

In addition to those dry year water supplies identified in the 2020 UWMP, SCV Water has identified two additional groundwater banking programs. While not a part of the resource mix currently incorporated into the water supply reliability tables in the 2020 UWMP or this WSA, these projects represent projects that SCV Water could consider providing redundancy or substitute for some portion of the UWMP’s programs if those were not brought online.

The first is the High Desert Water Bank being developed by the Antelope Valley East Kern Water Agency. The project overlies an adjudicated groundwater basin in the Antelope Valley. The Metropolitan Water District of Southern California has contracted with AVEK to develop the first phase of the project’s four phases. The first phase will store up to 200,000 AFY with 70,000 AFY of recovery capacity. AVEK is currently working with SCV Water and other SWP Contractors including Santa Clara Valley Water District, and Palmdale Water District to define the second phase. The second phase may incorporate a direct connection to the West Branch of the California Aqueduct to facilitate return deliveries. The location of this water bank is desirable as it is located south of the San Andreas Fault. The second phase could provide SCV Water with up to 80,000 AF of storage with recovery capacity of up to 20,000 AFY.

The second is the Aquaterra Water Bank being developed by the McMullin Groundwater Sustainability Agency. This water bank in Fresno County adjacent to Delta Mendota Pool, is projected to store up to 800,000 AF and have an extraction capacity of 146,000 AFY. Water would be available to SWP Contractors and Central Valley Project Contractors through an exchange with the Central Valley Project participating Contractors. The McMullin GSA intends to initiate environmental review for this project in 2022. SCV Water

could potentially participate in this project at levels similar to those contemplated for the AVEK High Desert Water Bank.

3.6 Planned Water Supply Projects and Programs

SCV Water prepared the Water Resources Reconnaissance Study (Study) (Carollo, 2015). The Study discusses the potential for acquiring additional water supplies. The Study evaluated a series of supply measures in the hopes that an additional 10,000 AFY of supply could be made available to the service area. The study identified two local measures that might enable SCV Water to get at least part way to that goal: (1) a groundwater recharge project using recycled water and (2) an imported water injection project during wet years to augment Saugus formation groundwater storage. Both projects were evaluated at the conceptual level, but significantly more investigation would need to be completed before either was implemented.

While the recycled groundwater recharge measure is not currently being pursued, as detention and dilution challenges were analyzed by Trussell Technologies Inc in its USCR Watershed Recharge Feasibility Study, 2017. SCV Water continues investigating the potential to spread imported water directly into the Alluvial Aquifer at several sites. Promising infiltration tests have been conducted on SCV Water owned property adjacent to Castaic Creek. Additional siting is being conducted along the easterly portions of the Santa Clara River. Further, the potential exists to cooperate with the City of Santa Clarita to use future storm water detention facilities. One such site is located near along the Santa Clara River near the intersection of Whites Canyon Road and Via Princessa.

3.6.1 Sites Reservoir

Sites Reservoir is a proposed new 1,500,000 acre-feet off-stream storage reservoir in northern California near Maxwell. Sacramento River flows will be diverted during excess flow periods and stored in the off-stream reservoir and released for use in the drier periods. Sites Reservoir is expected to provide water supply, environmental, flood, and recreational benefits. The proponents of Sites Reservoir include 23 entities including several individual SWP PWAs including SCV Water. Sites Reservoir is expected to provide approximately 240,000 AFY (Sites Reservoir Value Planning Report, 2020, Table 8-1) of additional deliveries on average to participating agencies under existing conditions. SCV Water's current participation is 3% of that total. Further, SCV Water would operate its share of project storage so as to maximize delivery during dry and critically dry years and the project is projected to provide between 9,800 and 7,100 AFY depending on final project configuration and level of Federal participation by the United States Bureau of Reclamation (USBR). Sites Reservoir is currently undergoing environmental planning and permitting. Full operations of the Sites Reservoir are estimated to start by 2029 following environmental planning, permitting, and construction. Sites was conditionally awarded \$816 million from the California Water Commission for ecosystem, recreation, and flood control benefits under Proposition 1. Reclamation may also invest in Sites under the Water Infrastructure Improvements for the Nation (WIIN) Act and recently transmitted a final Federal Feasibility Report to Congress for the project.

DWR estimates of SWP supply reliability in its 2019 DCR are based on existing facilities, and do not include the proposed Sites Reservoir. SCV Water along with other SWP public water agencies and north of Delta participants, however, are members of the Sites Reservoir Committee and are sharing costs, to advance environmental, permitting, and other planning activities. The Sites Reservoir staff has performed modeling of potential water supply from this project. While not identified as a project in the reliability tables provided in this WSA, the project is analyzed as part of the SCV Water's Updated Water Reliability Report and could serve as an alternative if other future water supply programs are not feasible. The Capital Improvement section of SCV Water's current FY 2021-22 FY2022-23 Capital Budget provides for continued participation

in the planning of Sites Reservoir. At the end of the planning period the project is anticipated to complete CEQA and NEPA documentation, have acquired water rights and key permits including incidental take permits. The project is scheduled to become operational in 2030.

3.7 Recycled Water

This section of the WSA describes the existing and future recycled water opportunities available to the SCV Water service area. The description includes estimates of potential recycled water supply and demand through 2050 in five-year increments, as well as SCV Water's proposed incentives and implementation plan for recycled water.

As discussed below, SCV Water's source of supply for current and planned recycled water consists of flows coming from the Valencia Water Reclamation Plant and the future Newhall Ranch Water Reclamation plant as well as the Vista Canyon Ranch Water Factory (Vista Canyon WRP). SCV Water recently extended the term of its recycled water purchase agreement with the Santa Clarita Valley Sanitation District (SCVSD) and is currently negotiating a recycled water purchase agreement with the City of Santa Clarita for supplies from the Vista Canyon WRP. An additional recycled water purchase agreement with the Newhall Ranch Sanitation District is anticipated when it becomes operational. Collectively these sources are anticipated to make 8,961 AFY available to SCV Water. That supply includes 450 AFY to existing users identified under SCVSD's approved State Water Resources Control Board petition. Currently planned additional supplies would be developed under the SCV Water's New Drop Program, which is based on using wastewater flows from new customers rather than treated wastewater that has historically been discharged into the Santa Clara River. The New Drop Program would not require a requested change to the SCVSD's existing petition. This is particularly important because there are potential regulatory challenges to using additional recycled water that would reduce flows in the Santa Clara River. This is discussed in more detail below.

Recycled water is dependent on potential user demands, availability of supplies, and the economics and feasibility of serving those users. The Draft Update of the Recycled Water Master Plan identified over 20,000 AFY of existing and future landscape demands that could potentially be irrigated using recycled water. However, due to the potential need for instream flows and feasibility considerations including costs, SCV Water plans call for a recycled water distribution system that would be sufficient to meet demands of 9,749 AFY. This includes SCV Water's Phase 1 project, which is currently serving 450 AF of demand, along with its Phase 2 projects and certain non-potable irrigation systems to be constructed by a developer for a specific project described in more detail below.

As discussed below, additional opportunities to further expand recycled water use will be evaluated as part of SCV Water's Water Resilience Initiative, however, these have not been incorporated into the prospective water supplies accounted for in Section 3.

3.7.1 Recycled Water Master Planning Efforts

It is anticipated that water demands will continue to increase as a result of a growing population. Accordingly, SCV Water is planning to secure additional reliable sources of water to help meet projected water demands. SCV Water recognizes that recycled water is an important and reliable source of additional water that should be pursued as an integral part of the SCV Water's water supply portfolio. Recycled water enhances reliability in that it provides an additional source of supply and allows for more efficient utilization of potable groundwater and imported water supplies. Draft Recycled Water Master Plans for the SCV Water service area were completed in 1993 and 2002. These master plans considered various factors

affecting recycled water sources, supplies, users and demands so that SCV Water could develop a cost-effective recycled water system within its service area. In 2007, SCV Water completed CEQA analysis of the 2002 Recycled Water Master Plan (RWMP). This analysis consisted of a Programmatic EIR covering the various phases for a recycled water system as outlined in the RWMP. The Programmatic EIR was certified by the, then, CLWA Board in March 2007.

An update to the RWMP was initiated in 2016 (Kennedy/Jenks 2016) based on recent developments affecting recycled water sources, supplies, uses, and demands. The update was not completed but it provides important guidance on feasible projects in the short term. One reason the study was not finalized was in part due to ongoing litigation related to recycled water supplies between the Affordable Clean Water Alliance and SCVSD, which is SCV Water’s main supplier of recycled water. Further, SCV Water anticipates undertaking a water resiliency planning process that would in part explore the interconnection of future groundwater operations, recycled water usage, and environmental uses of water in the USCR Watershed. It is anticipated that this effort would inform future environmental evaluations and permitting for future projects and programs. Overall, recycled water uses included in this WSA and the 2020 UWMP update include uses prioritized in the Kennedy/Jenks 2016 report and available supplies from the SCV Water New Drop program.

Table 3-9 provides a list of entities that participate in the implementation of the RWMP and RWMP Update. In accordance with Water Code section 10633, the preparation of the 2020 UWMP was also coordinated with these entities.

**TABLE 3-9
PARTICIPATING ENTITIES^(a)**

Participating Entities	Role in Plan Development
SCV Water	Retail and Wholesale water provider
Los Angeles County Waterworks District No. 36	Retail water purveyor
Santa Clarita Valley Sanitation District	Recycled Water supplier
Berry Petroleum	Potential recycled water supplier
City of Santa Clarita ^(b)	Potential recycled water supplier

Notes:

(a) The Newhall Ranch Water Reclamation Plant would serve the Newhall Ranch Specific Plan and will be owned and operated by the Newhall Ranch Sanitation District.

(b) The City of Santa Clarita will eventually operate the Vista Canyon Water Reclamation Plant.

SCV Water has constructed Phase 1 of the 2002 RWMP (Kennedy Jenks 2002), which delivers on average approximately 450 AFY. Although the original SCVSD contract and applicable permits anticipate the use of 1,600 AFY for this initial phase project, demands for recycled water have not developed at all the specific places of use identified in the SCVSD’s SWRCB Water Code Section 1211 petition. Deliveries of recycled water began in 2003 for irrigation water supply and currently serve a golf course, a shopping center, and roadway median strips. Use of the remaining volumes at new locations would require submission and approval of a revised petition, triggering a similar State Water Resources Control Board petition process to the new petition described below.

Phase 2 is planned to expand recycled water use within Santa Clarita Valley and consists of four projects currently in various stages of design and/or construction. All available recycled water from the SCV Water’s

New Drop Program in the peak summer months is anticipated to be used to meet the demands of these Phase 2 expansions currently in design and construction, including planned developments by Five Point that are referred to as the Westside communities

3.7.2 Existing Wastewater Treatment Facilities

SCVSD owns and operates two Water Reclamation Plants (WRPs), the Saugus WRP and the Valencia WRP, within the SCV Water service area. The water is treated to disinfected tertiary levels and, with the exception of water used in Phase I of the RWMP, is discharged to the Santa Clara River. The Newhall Ranch and Vista Canyon developments will have their own dedicated tertiary treatment WRPs, and non-potable recycled water from these sources, when available, is anticipated to be incorporated directly into the recycled water system.

The Valencia WRP, completed in 1967, is located on The Old Road near Magic Mountain Amusement Park. The Valencia WRP has a current treatment capacity of 21.6 million gallons per day (MGD), equivalent to 24,190 AFY, developed over time in stages. The average annual production is 15,500 AFY of tertiary recycled water. Use of recycled water from the Valencia WRP for irrigation use is permitted under Los Angeles Regional Water Quality Control Board (LARWQCB) Order Nos. 87-48 and 97-072.

The Saugus WRP, completed in 1962, is located southeast of the intersection of Bouquet Canyon Road and Soledad Canyon Road. The Saugus WRP has a current treatment capacity of 6.5 MGD (7,280 AFY). No future expansions are possible at the plant due to space limitations at the site. In 2020 the Saugus WRP produced 5,150 AFY of tertiary recycled water. Use of recycled water from this facility is permitted under LARWQCB Order Nos. 87-49 and 97-072.

The Saugus and Valencia WRPs operated independently of each other until 1980, at which time the two plants were linked by a bypass interceptor. The interceptor was installed to transfer a portion of flows received at the Saugus WRP to the Valencia WRP. Together, the Valencia and Saugus WRPs have a design capacity of 28.1 MGD (31,470 AFY) and produce 20,450 AFY of treated effluent on average. The primary sources of wastewater to the Saugus and Valencia WRPs are domestic. Both plants are tertiary treatment facilities and produce high quality effluent. Historically, the effluent from the two WRPs has been discharged to the Santa Clara River. The Saugus WRP effluent outfall is located at Bouquet Canyon Road. Effluent from the Valencia WRP is discharged to the Santa Clara River at a point approximately 2,000 feet downstream (west) of The Old Road Bridge.

SCVSD is currently constructing advanced treatment facilities (AWT) to desalinate tertiary recycled water with a capacity of approximately 6,000 AFY to comply with the Regional Water Quality Control Board, Los Angeles Region Chloride Total Maximum Daily Load (TMDL). The facilities are sized to treat enough disinfected tertiary recycled water to blend down the chloride levels for discharge to the Santa Clara River at the design capacity of the combined Saugus and Valencia WRPs at chloride levels during a drought. Since design capacities will not be reached for a decade or more and chloride levels on average are much lower during average precipitation years, the AWT will have excess capacity that could be utilized to produce desalinated water for reuse purposes for sale to SCV Water. Desalinated recycled water could be used to improve water quality or for indirect potable reuse in the future but only with the construction of additional treatment.

3.7.3 Wastewater Treatment Facility Improvements and Expansions

A third reclamation plant, the Vista Canyon Water Factory (Vista Canyon WRP), has been constructed as a part of the Vista Canyon Project. The plant is located near Highway 14, just south of the Santa Clara River and will be operated by the City of Santa Clarita. The plant will have an ultimate capacity of 440 AFY (Kennedy Jenks, 2015). The Vista Canyon Development is anticipated to use 137 AFY of the recycled water supply and the remaining excess flow would be available for reuse as part of Vista Canyon Recycled Water Main Extension (Phase 2B) of the RWMP currently under construction.

It is intended that the Vista Canyon WRP would not discharge recycled water into the Santa Clara River. Excess recycled water production from the Vista Canyon WRP would be sent to the Valencia WRP.

A fourth Santa Clarita Valley (Valley) reclamation plant, the Newhall Ranch WRP, is proposed as part of the Newhall Ranch project. This proposed facility would be located near the western edge of the development project along the south side of State Route 126. The Newhall Ranch WRP would serve the Newhall Ranch Specific Plan and will be owned and operated by the Newhall Ranch Sanitation District. Prior to Newhall Ranch WRP being available, Newhall Ranch Specific Plan generated wastewater would be temporarily treated at the Valencia WRP, based on the need to build up an adequate, steady flow of wastewater before constructing the initial increment of capacity at Newhall Ranch WRP. The Valencia WRP has sufficient capacity to tertiary-treat wastewater from the Newhall Ranch Specific Plan during this interim period, consistent with the Interconnection Agreement approved by SCVSD in 2002 and the Joint Sewerage Services Agreement entered between SCVSD and NRSD in 2017. The Newhall Ranch WRP currently has a permitted capacity of 2.0 MGD (approximately 2,200 AFY) but is anticipated to produce 4,200 AFY at ultimate buildout. Recycled water from the Valencia WRP would be used to meet the remainder of the non-potable demands there, to the extent available in accordance with the Interconnection Agreement. If for any reason, however, recycled water supplies from the Valencia WRP and/or other local WRPs are not available in the amounts anticipated to meet the projected recycled water demands for that development, other sources of supply available to SCV Water as provided in the 2020 UWMP would be utilized to serve non-potable demands until such time as recycled water supplies may become available.

3.7.4 New Drop Program

As a means of developing additional recycled water supplies, without increasing the diversion of recycled water flows discharged to the Santa Clara River, SCV Water has developed the New Drop Program to utilize and account for “new” recycled water flows. These additional recycled water supplies would be derived from wastewater flows generated from new residential and commercial development. The New Drop Program accounts for the increase in wastewater flows associated with new development and separates these projected wastewater flows from existing flows discharged to the Santa Clara River. As new development occurs, potential additional recycled water supplies would be quantified through calculations and measurements. The New Drop Program is illustrated in Figure 3-1 below.

**FIGURE 3-1
NEW DROP PROGRAM PROCESS**

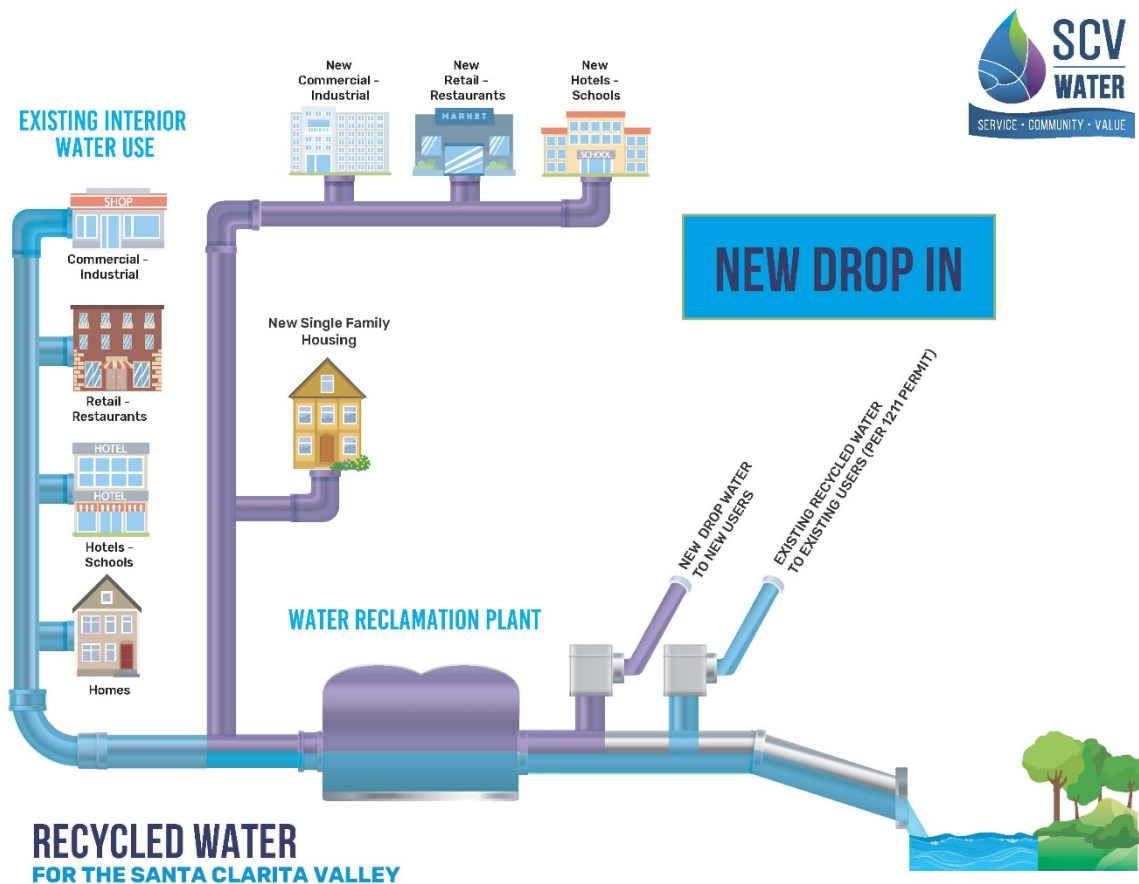

The use of recycled water under the New Drop Program does not constitute a reduction to a surface stream, specifically a reduction in flow in the Santa Clara River. As a result, a Section 1211 wastewater change petition is not required to implement the recycled water program. However, in order to utilize these recycled water supplies in accordance with SWRCB requirements, SCV Water has been working to obtain formal approvals. A Notice of Applicability under the General Order No. WQ 2016-0068-DDW, Water Reclamation Requirements for Recycled Water Use, was issued in April 2020 for SCV Water’s use of recycled water from the Valencia WRP for non-irrigation uses as part of the New Drop Program. Upon review of the Title 22 Report and related project documentation, the LARWQCB and the SWRCB determined that the New Drop Program satisfies the general and specific conditions of the General Order and does not require a change of use permit under Water Code section 1211. SCV Water is also in the process of requesting expanded use of the New Drop Program recycled water from the Valencia WRP for irrigation uses, currently allowed under Order No. 97-072. An addendum to the original Title 22 Engineering Report was submitted in December 2020 for Phase 2D. The final revised Engineering report is scheduled to be submitted during the first half of 2022.

3.7.5 Instream Flow Requirements

In general, the use of recycled water from the WRPs is limited and can be affected by various state water laws, codes, and regulatory and court decisions, which are summarized in the RWMP Update. The production, discharge, distribution, and use of recycled water are subject to federal, state, and local regulations; the primary objectives of which are to protect public health. Appendix B of the RWMP summarizes the regulatory requirements and their administration, with an emphasis on regulations relating to the distribution and use of recycled water in California. Use of recycled water from the Valencia and Saugus WRPs is permitted under Los Angeles RWQCB Order Nos. 87-48 and 87-49, respectively and re-adopted by Order No. 97-072. Copies of these recycled water permits, along with SCVSD Ordinances and Requirements for Recycled Water Users in Santa Clarita Valley and Los Angeles County Department of Public Health (CDPH) guidelines and inspection requirements, are provided in the Santa Clarita Valley Rules and Regulations Handbook (Kennedy Jenks 2016b).

SCV Water has a contract with the SCVSD to use recycled water from the Valencia WRP, which was recently extended through 2026. The contract permits SCV Water to receive 1,600 AFY, corresponding to the amount of recycled water permitted for reuse by the SWRCB. However, as noted above that permit limited uses to specific approved sites and because demand at some of those sites has not materialized, current use is limited to only about 450 AFY.

The New Drop Program will generate additional supplies and those supplies will be available to multiple new use sites when and as they are connected to the expanding recycled water system.

At this time, SCVSD is not seeking an amendment to its SWRCB petition to increase the amount of recycled water it may deliver that has historically been discharged into the Santa Clara River. In the future, if SCV Water develops feasible projects to use recycled water in amounts greater than the New Drop Program supplies, it is anticipated that SCV Water and SCVSD would cooperate in obtaining any necessary permits from the SWRCB. Obtaining an approved petition will require compliance with CEQA. However, as indicated above and described in more detail below, SCVSD's previous evaluations of potential withdrawals of discharge from the Santa Clara River to use for recycled water have been the subject of litigation.

In October 2013, the SCVSD Board certified an EIR (2013 EIR) that included two components: (1) the Chloride Compliance Project to remove chloride from wastewater to meet the Chloride TMDL and (2) a Recycled Water Project to make treated wastewater available for reuse. The Chloride Compliance Project consists of 3 main elements that include ultraviolet disinfection at the Saugus and Valencia WRPs, AWT at Valencia WRP, and brine management and disposal. The Recycled Water Project was designed to support municipal reuse of recycled water and was solely focused on proposed future reductions in discharges of recycled water to the Santa Clara River.¹¹

The 2013 EIR was subsequently challenged by the Affordable Clean Water Alliance (ACWA) on the grounds that the document failed to comply with CEQA. The LA Superior Court (the Court) did not find any deficiencies in the environmental analysis related to the Chloride Compliance Project; however, the Court found two aspects of the 2013 EIR did not fully comply with CEQA. First, the Court found that the 2013 EIR lacked substantial evidence to support the conclusion of no significant impacts on populations of the

¹¹ No recycled water infrastructure, such as treatment, pump stations or pipelines, were included in the scope of the Recycled Water Project.

unarmored threespine stickleback fish (UTS) with respect to the reduced discharge to the Santa Clara River associated with the Recycled Water Project; and second, the 2013 EIR lacked a clear brine management alternative because of the "abandonment" of the deep well injection brine management method approved in the 2013 EIR, making the Chloride Compliance Project incomplete.

In an effort to move forward with the Chloride Compliance Project, SCVSD separated the Chloride Compliance Project from the Recycled Water Project and, in 2017, certified a Recirculated EIR evaluating the Chloride Compliance Project separate from the Recycled Water Project.

SCVSD proceeded with the Recycled Water Project on a separate, but parallel path. SCVSD retained a consultant and engaged in consultations with CDFW. SCVSD released a Notice of Preparation (NOP) in August 2016. In response to the NOP, CDFW wrote a letter indicating that they could not conclude that the project would not result in take of UTS and recommended that SCVSD do additional studies and consider applying for an Incidental Take Permit under the California Endangered Species Act prior to implementing the project. Further, in summer 2018, CDFW requested additional review to analyze potential impacts to groundwater and surface water levels because of the proposed reduction in discharge from the Valencia WRP. At the time, a comprehensive model needed to evaluate surface water and groundwater level impacts did not exist. Given that the SWRCB defers to CDFW in matters related to habitat when considering petitions for reduction in discharges and the positions expressed by CDFW, SCVSD determined that obtaining a 1211 petition from the SWRCB for a reduction in discharge would be very difficult.

By resolution dated February 2019 SCVSD stated it had no current intent to proceed with an EIR related to the support of additional recycled water development by reducing existing discharge to the Santa Clara River. The decision by SCVSD to remove the recycled water component and approve the modified chloride compliance project had been challenged in separate lawsuits filed in Los Angeles Superior Court from 2017-2019. The cases have recently been resolved in favor of SCVSD, who is proceeding with its chloride compliance project.

SCV Water would undertake thorough and careful evaluation of effects on the Santa Clara River and would consult with California Department of Fish and Wildlife (CDFW) before proposing any project to reduce existing discharges and supply additional recycled water within the SCV service area.

3.7.6 Other Potential Sources of Recycled Water

Oilfield produced water is a by-product of oil production generated when oil is extracted from the oil reservoir. It is generally of poor quality and unsuitable for potable, industrial, or irrigation use without treatment. Because of the poor water quality, reinjection has often been the most cost-effective disposal option. Treatment processes can produce potable quality water; yet, because of the poor initial water quality and the organic constituents, it is often more appropriate for treated oilfield produced water to be used for irrigation or industrial purposes to offset potable water demand. The economics of oil production are market-driven and are different from those of drinking water supplies. As oil prices rise or drop, oilfield production is increased or decreased as dictated by economics. Also, oilfields are eventually depleted of supply and abandoned. Therefore, while oilfield produced water should be considered as long-term, it is not a completely firm supply and is not permanent.

Berry Petroleum has expressed interest in the past in treating oilfield produced water from the Placerita Oilfield for sale to SCV Water for non-potable uses. Studies of the potential reuse of treated oilfield produced water from the Placerita Oilfield have indicated that approximately 44,000 barrels per day (1.8 MGD or 2,016 AFY) of treated oilfield produced water may be available. Pilot studies performed at the

Placerita Oilfield have indicated that, even with reverse osmosis (RO) treatment, some organic compounds such as naphthalene, 2-butanone and ethylbenzene can be detected in the RO effluent. For irrigation reuse, the produced water would need to be cooled and treated to remove hardness, silica, total dissolved solids (TDS), boron, ammonia, and total organic carbon (TOC).

Due to water reliability and water quality issues, the use of oilfield produced water for a source of recycled water was not considered in the 2016 Salt and Nutrient Management Plan (SNMP) or in the RWMP Update and was not included as a supply opportunity in the 2020 UWMP.

3.7.7 Recycled Water Supply and Demand

Recycled water has the potential to play a critical role in meeting a portion of future water demands in the Valley, as the population grows. SCV Water is in various stages of planning and constructing its Phase 2 projects. SCV Water has included Phase 2 projects in its capital program. Phase 2B and 2D are currently under construction. Further, Phase 2C is currently under design. Additionally, Five Point's Westside development projects are proceeding with construction of the Mission Village project currently underway. A summary of demands anticipated from these activities are shown in Table 3-10.

**TABLE 3-10
EXISTING AND PROJECTED RECYCLED WATER DEMAND**

Phase/Project	Demand (AFY)	Timeframe for Coming Online	Source of Recycled Water	Location of Use/Water Service Area
Phase 1	450	Existing	Valencia WRP	VWD
Phase 2A	560	2029	Valencia WRP	NCWD, VWD
Phase 2B	300	2021-2023	Vista Canyon WRP	SCWD
Phase 2C	759	2021-2023	Valencia WRP	NCWD, VWD
Phase 2C – Golf Course ^(a)	600	2023	Valencia WRP	Valencia Golf Course
Phase 2D	221	2021-2023	Valencia WRP	VWD
Five Point ^(b)	5,174-6,505	2021-2043	Newhall Ranch/ Valencia WRP	Newhall Ranch/Five Point
Total	8,064-9,395	2050	As shown above	As shown above

Notes:

- (a) Raw water conversion to recycled water (not an existing potable offset).
- (b) Range reflects estimated demand using MEWLO and observed over watering of 25.6% in recently developed irrigation systems.
- (c) Assumes 3.77% demand increase due to climate change.

As previously discussed, aside from the existing 450 AFY of recycled water supply, planned recycled water supplies from the Valencia, Newhall Ranch, and Vista Canyon WRPs would come from the New Drop Program. Importantly, as indicated above, water from these New Drop Program sources would not be required to maintain environmental discharges to the Santa Clara River. As a result, it would be available to meet a considerable portion of the total projected long-term recycled water demands.

Total projected recycled water use projections through 2050 are summarized in Table 3-11. As annual demands discussed above exceed supplies, recycled water usage is based on available supplies. In later

years, it is projected that seasonal storage may be needed to store recycled water during the winter months to help meet peak summer demands. Additionally, potable make-up water will be needed to help meet summer peaking demands in the non-potable irrigation system.

**TABLE 3-11
PROJECTED RECYCLED WATER USE**

	2025	2030	2035	2040	2045	2050
Existing Recycled Water Use	450	450	450	450	450	450
New Recycled Water Use	1,849	3,696	5,091	6,498	7,499	8,511
Total Projected Recycled Water Use^(a)	2,299	4,146	5,541	6,948	7,949	8,961
Total Potential Recycled Water Demand^(b)	4,559	6,514	8,441	9,191	9,469	9,749

Notes:

- (a) Total projected water use is equal to total projected recycled water supply as total potential recycled water demand exceeds total projected supply.
- (b) Difference in recycled water supply and total potential recycled water demand will be made up by potable water supplies, i.e., make-up water.

In accordance with the UWMP Act, the 2020 UWMP describes and quantifies the potential uses of recycled water in the Valley based on the substantial wastewater flows and recycled water generated by the local WRPs. However, as noted above, if recycled water supplies from the local WRPs are not available in the amounts identified in Table 3-11 to meet potential uses because of regulatory or other constraints, other sources of supply available to SCV Water as provided in the 2020 UWMP would be utilized to meet non-potable demands until such time as recycled water supplies may become available.

3.7.8 Recycled Water Demand

Currently, an average of 450 AFY of recycled water is served to landscape irrigation customers, including The Oaks Club golf course (formerly known as the Tournament Players Club Golf Course). Potential recycled water users have been identified through several sources including:

- 1993 Recycled Water Master Plan
- Water consumption records for SCV Water and LACWWD 36
- Land use maps
- General Plans and Specific Plans for the City of Santa Clarita and County of Los Angeles
- Discussions with City, County, SCV Water, LACWWD 36 and land developer staff
- On-site surveys of the SCV Water service area
- 2002 Recycled Water Master Plan
- 2016 Recycled Water Master Plan Update (in development)

To be considered as a potential recycled water user, the user must be located within SCV Water's service area and have a potential non-potable water demand of at least 50,000 gallons per day. At this time no specific or Valley-wide ordinance(s) or other enactments are proposed that would require the installation of dual distribution systems for recycled water, or that would require the use of recycled water for recirculating uses. A total existing demand of approximately 12,000 AFY (based on current non-potable uses from irrigation meters) and a future demand of 8,511 AFY (based on planned developments), totaling approximately 21,000 AFY. The majority of recycled water uses are projected to be landscape irrigation.

As noted above, Phase 1 of the RWMP has been constructed and begins with a 4,000-gpm pump station at the Valencia WRP that connects to a 1.5 MG reservoir in the Westridge area with 15,600 linear feet of 24- and 20-inch pipeline. It serves landscape customers along The Old Road and The Oaks Club at Valencia.

Four projects planned to expand recycled water use within Santa Clarita Valley, which are collectively known as Phase 2.

Phase 2A, 2C and 2D would use recycled water from the Valencia WRP and Phase 2B would use recycled water produced at the Vista Canyon WRP, which will treat flows from the planned Vista Canyon Development. Phase 2A would serve Central Park and customers along the path from the Valencia WRP to the park. Phase 2B would serve the proposed Vista Canyon Development and nearby irrigation customers. Phase 2C would serve Valencia Country Club, Vista Valencia Golf Course, College of the Canyons, California Institute of the Arts, Hart High School, and Newhall Elementary School. Phase 2D would serve West Ranch High School, Ranch Pico Junior High School, Oak Hills Elementary School, and customers along the way.

Anticipated annual demands and completion dates for Phase 2 components are listed below:

- Phase 2A: 560 AFY in 2029
- Phases 2B, 2C, 2D: 1880 AFY between 2021 and 2023 (1,200 AFY would consist of raw water conversion to non-potable at the Valencia golf course by 2023). Phase 2D and 2B are under construction.

In addition, the FivePoint project is anticipated to result in 5,174 AFY of demand between 2021 and 2043. These Phase 2 and FivePoint anticipated demands take into account demand adjustment factors over the planning period.

Future recycled water use expansion beyond Phase 2 was explored as part of the RWMP Update and could potentially include extensions of the Phase 2 alignments to utilize any additional available recycled water resulting from a decrease in discharges from the Valencia WRP. However, as discussed above there are no current plans to pursue reduction of discharges from the Valencia WRP to the Santa Clara River. Current plans call for reliance on the SCV Water's New Drop Program. Consistent with the New Drop Program there is currently no plan to use recycled water from the Saugus WRP since the majority of the effluent is committed to meeting discharge requirements in the Santa Clara River.

The RWMP Update also included a high-level assessment of opportunities for potable reuse within the Santa Clarita Valley via groundwater recharge, surface water augmentation and direct potable reuse and the development of seasonal storage (Woodard and Curran 2021). In general, due to the seasonal variability of recycled water demand, SCV Water has an excess of recycled water supply during the winter months. Excess recycled water flows are currently discharged to the Santa Clara River. These excess flows could be better utilized by constructing seasonal storage facilities which can store recycled water during winter months when the demands are low and feed the system with the stored supply in the summer months when demands exceed the operational supply. These opportunities would be evaluated further in future UWMP updates.

- **Groundwater recharge (“indirect potable reuse”) via surface spreading** at an off-stream location near the Santa Clara River could provide for recharge of excess available recycled water in the winter and off-peak irrigation months. A more detailed feasibility study would be required to

confirm the volume of recycled water that could be recharged and recovered based on current regulations, source water quality, operational and cost considerations.

- **Surface Water augmentation** at Castaic Lake would require full advanced treatment of the recycled water from SCVSD, brine disposal and significant conveyance requirements at a very high cost. It is also unknown at this time whether a surface water augmentation project would be able to meet applicable regulatory criteria and how much water could be augmented.
- **Direct potable reuse (DPR)**, though not currently permitted in California, would involve the purposeful introduction of highly purified recycled water into a drinking water supply, immediately upstream of a drinking Water treatment plant or directly into the potable water supply distribution system downstream of a water treatment plant. A DPR concept could potentially utilize recycled water not already allocated or planned for non-potable reuse or determined necessary for instream use and would require full advanced treatment of the recycled water from SCVSD, brine disposal and only minimal conveyance requirements. SCV Water intends to track direct potable reuse developments in California and revisit the feasibility of DPR in the future.

3.7.9 Recycled Water Comparison

The 2015 UWMP projected a total recycled water demand of 1,015 AFY by the year 2020. Actual data shows 468 AF was served in 2020 which reflects the existing golf course and landscape demands. 2020 demand is lower than originally predicted because the recycled water distribution system expansion did not occur as anticipated. Table 3-12 provides a comparison of the projected versus the actual 2020 demand. Based on current estimates, recycled water demand over the next five years is anticipated to increase 10-fold as shown in Table 3-12.

**TABLE 3-12
RECYCLED WATER USES – PROJECTION COMPARED WITH ACTUAL USE (AFY)**

User Type	2015 Projection for 2020	2020 Actual Use
Landscape	622	99
Golf Course Landscape	393	375
Total	1,015	468

3.7.10 Methods to Encourage Recycled Water Use

Currently, to the extent feasible SCV Water is offering recycled water as available at a lower rate to encourage the use of recycled water and to help offset some of the conversion costs. SCV Water is considering pricing options to encourage participation in the recycled water program. In addition to pricing incentives SCV Water is committed to a Valley-wide messaging regarding recycled water benefits and costs. At its March 2, 2021, Board Meeting, SCV Water authorized the General Manager to implement a Purple PREP (Planning Readiness and Effectuating Program) Pilot to facilitate conversion of the Phase 2B and 2D customer irrigation systems to recycled water. Under the program customers can choose either direct installation of required retrofit materials or receive a financial incentive up to the actual cost of the retrofit. Other incentives may include financial assistance to offset the costs to convert (or retrofit) potable water systems or the development of a Valley-wide recycled water ordinance, which would require the use of recycled water if available, rather than relying solely on pricing incentives and voluntary connections.

It is important to note that SCV Water's New Drop Program is a critical component for optimizing recycled water use across the service area. As described above, this program allows SCV Water to develop additional recycled water supplies from wastewater flows generated from new residential and commercial development, without increasing the diversion of recycled water flows discharged to the Santa Clara River.

3.7.11 Optimization Plan for Recycled Water

Currently, the amount of recycled water available from the WRPs is not adequate to meet the total demands of the completed recycled water system, which relates to both infrastructure and regulatory factors. Notably, however, as potable water demands increase in the Valley over time, wastewater flows will increase and the amount of recycled water production to meet future system demands would also increase. Therefore, SCV Water anticipates that construction of the recycled water system will be phased to utilize the increases in WRP production. A detailed discussion of the recommended phasing plan was provided in the RWMP Update.

Phasing implementation of the recycled water system is recommended for the following reasons:

- A number of the potential recycled water users are future users that do not yet need recycled water.
- The current amount of recycled water available from the local WRPs is not yet adequate to meet the total demands of all the existing *and* planned future identified recycled water users.
- Capital funding requirements would be spread over the current planning period through 2050.

The implementation phases are prioritized based on the status of the potential recycled water users (existing or future), the anticipated construction schedule of future users and the proximity of the users to the non-potable water source (e.g., Valencia WRP, Vista Canyon WRP and Newhall Ranch WRP).

Phase 2A, 2B, 2C and 2D are planned for construction over the next 10 years and would increase recycled water deliveries by approximately 2,440 AFY. These projects are being prioritized to take advantage of available funding for recycled water projects under Proposition 1 and to align with the construction schedule for the Vista Canyon Development.

The Newhall Ranch/Five Point project represents the next major increase in recycled water use and is anticipated to be constructed over the next 20 to 25 Years. These facilities will be paid for by the developer.

As these uses come on-line, recycled water demand may exceed supplies particularly during the summer months, thus the distribution to future users would be based on the following considerations:

- Service area boundaries,
- Ease or willingness of customers to connect to recycled water,
- Capital and operational costs,
- Funding availability,
- Community impacts and development requirements,
- Supply reliability and system flexibility considerations, and
- Availability of recycled water supplies due to regulatory or other legal constraints.

3.7.12 Additional Considerations Relating to the Use of Recycled Water

Additional information relating to recycled water concerning the SCVSD Chloride Compliance Plan, and the groundwater basin's Salt and Nutrient Management Plan are in the 2020 UWMP.

3.7.13 Capital Outlay Program

Financing the delivery of water supplies for SCV Water's customers, including this project, are set forth in SCV Water's Biennial Budget for FY 2021/22 and FY 2022/23. The link to these documents is on Page 6-6 of this Water Supply Assessment. Water operations and new projects are paid from various funds as described below:

- General Fund – Fund used to account for and report all financial resources not accounted for and reported in another fund
- Capital Project Fund – Capital projects that are financed
- State Water Contract Fund – Funds received from ad valorem property taxes for payment of DWR fixed and variable costs
- Facility Capacity/Connection Fees – Funds that are collected from development or developers

The Biennial Budget describes anticipated revenues from various sources such as water sales, taxes, and fees along with anticipated expenditures associated with these funds including those to pay for existing and new sources of water supply.

Further, the budget contains a Capital improvement section (pg. 131) that identifies near term capital expenditures and their funding sources. SCV Water plans to invest \$84 million in FY 21/22 and \$86 million in FY 22/23. (pg. 133). These include projects described in this section such as installation of treatment facilities for Perchlorate and PFAS impacted wells, construction of new Saugus Formation wells, and construction of recycled water facilities.

The capital budget also contains expenditures for planning efforts for new projects such as additional extraction capacity from new banking programs and Sites Reservoir planning costs. A summary of expenditures and revenues are shown on the Tables on page 136 and 137 of the budget, with individual project summaries on the following pages. Some of the future water projects will be the subject of future budgets to be adopted by the SCV Waters Board of Directors.

Section 4: Supply Reliability Planning and Accounting for Uncertainties Associated with Groundwater Contamination and other Factors

Planning for water supplies in California inherently involves the management of risks and uncertainties. Changes in public policy, regulatory requirements, and advancement of scientific knowledge can all affect future water supplies. This section addresses some of these risks and uncertainties that SCV Water is managing. Specifically, this section addresses risk and uncertainties associated with water quality, specifically restoration of existing wells and proposed wells given ongoing groundwater contamination, how climate change may impact various sources of supplies and demand for water, and how ongoing development of new water use efficiency may impact water supplies and demands. Finally, this section discusses how analysis undertaken by SCV Water in its Water Supply Reliability Plan Report, supplements the analysis performed in the 2020 UWMP and demonstrates how SCV Water can manage risk should the path to implementing certain future water supplies are blocked.

A key factor to meeting future demands is restoring existing groundwater supplies that are currently contaminated with Perchlorate, PFAS, and VOCs. This section provides a detailed discussion based primarily on Section 6 of the 2020 UWMP, regarding water quality and steps necessary to recover these supplies as well as access additional groundwater supplies from the Saugus Formation. The discussion in this report, however, contains certain updates regarding the schedules relating to recovery of existing well capacity impacted by contaminants.

Further, anticipated climate change is projected to impact nearly all of SCV Water's water supplies. While Sections 1.7 of the 2020 UWMP provides a summary of potential effects of climate change on California and the Santa Clarita Valley, this WSA provides additional discussions on how climate change information, based largely on State provided information, was incorporated into the water demands and water supplies analyzed in the 2020 UWMP and this WSA. This information was incorporated into SCV Water's 2021 Water Supply Reliability Plan Update that analyzed not only the proposed UWMP water resource mix, but alternative scenarios to achieve water supply reliability.

Additionally, the State is in the process of implementing two policy bills enacted by the California Legislature, Assembly Bill 1668 (AB1668, Friedman) and Senate Bill 606 (SB606, Hertzberg) that will provide new water efficiency standards that will eventually lead to enforceable urban water use objectives. Although these standards have not yet been adopted, implications to recycled water availability and urban water demand are discussed below.

4.1 Water Quality

The quality of any natural water is dynamic in nature. This is true for both the imported and local groundwater of the Basin. During periods of intense rainfall or snowmelt, routes of surface water movement may change resulting in variable quantities of constituents being mobilized. The quality of water changes over the course of a year. These same basic principles apply to groundwater. Depending on water depth, groundwater will pass through different layers of rock and sediment and potentially dissolve different materials from those strata, change concentrations due to oxidation or reduction reactions or precipitate constituents due to oversaturation. Water depth is a function of recharge from local rainfall and from

adjacent basins due to subsurface inflow and withdrawal from groundwater pumping. Water quality is not a static feature of surface water and groundwater, and these dynamic variables must be recognized.

Water quality regulations also change. This is the result of the discovery of new contaminants, updated understanding of the health effects of previously known as well as new contaminants, development of new analytical technology and the introduction of new treatment technology. Most water suppliers in California are subject to drinking water standards set by the United States Environmental Protection Agency (USEPA) and the SWRCB DDW, formerly the DPH. Additionally, each year prior to July 1st, a Consumer Confidence Report or Water Quality Report (WQR) is made available to all Valley residents who receive water from SCV Water. That report includes detailed information about the results of quality testing of the groundwater and treated SWP Water supplied during the preceding year (2020 WQR). Water quality is also addressed in the annual Santa Clarita Valley Water Report, which describes the current water supply conditions in the Valley and provides information about the water requirements and water supplies of the Santa Clarita Valley.

The quality of water received by individual customers will vary depending on whether they receive imported water, groundwater, or a blend. Some will receive only imported water at all times, while others will receive only groundwater. Others may receive water from one well at one time, water from another well at a different time, different blends of well and imported water at other times, and only imported water at yet other times. These times may vary over the course of a day, a week, or a year.

This section provides a general description of the water quality of the supplies within the Valley, aquifer protection and a discussion of potential water quality impacts on the reliability of these supplies.

4.2 Water Quality Constituents of Interest

SCV Water is committed to providing its customers with high quality water that meets all federal and state primary drinking water standards. Some contaminants are naturally occurring minerals and radioactive material. In some cases, the presence of animals or human activity can contribute to the constituents in the source waters. The following sections address constituents reported in the 2020 WQR and the 2019 Santa Clarita Valley Water Report (July 2020) that may impact water quality.

4.2.1 Perchlorate

Perchlorate, a chemical used in making rocket and ammunitions propellants as well as flares and fireworks, has been a water quality concern in the Santa Clarita Valley since 1997 when it was originally detected in four wells operated by SCV Water in the eastern part of the Saugus Formation, near the former Whittaker-Bermite facility. In late 2002, the contaminant was detected in a fifth well, this one located in the Alluvial Aquifer (Stadium Well) but also located near the former Whittaker-Bermite site, and which was immediately taken out of service. Of those wells, two (Well 157 and Stadium Well) were sealed and replaced by new wells (201 and Valley Center), and two others (Saugus 1 and 2) were returned to service with treatment by 2011. Well N-11 was taken out of service and remains out of service.

Perchlorate was detected again in early 2005 in a second Alluvial well (Well Q2) near the former Whittaker-Bermite site, and in 2006 in very low concentrations (below the detection limit for reporting) in a fifth Saugus well (Well N13) near one of the originally impacted wells.

In response to the detection of perchlorate at alluvial Well Q2, it was removed from active service, and the preparation of an analysis and report assessing the impact of, and response to, the perchlorate contamination of that well was commissioned. A capture zone analysis utilizing the numerical groundwater

flow model was conducted to assess the potential risk of perchlorate migration to Well Q2 and other nearby alluvial wells. This analysis determined that there was a low risk of perchlorate migration to Well Q2. The response for Well Q2 was to obtain permitting for installation of wellhead treatment, followed by the installation of treatment facilities, and returning the well to water supply service in October 2005. After nearly two years of operation with wellhead treatment, including regular monitoring specified by the DPH, all of which resulted in no detection of perchlorate in Well Q2, it was requested that DPH allow treatment to be discontinued. DPH approved that request in August 2007, and treatment was subsequently discontinued. In 2019, perchlorate was detected again in Well Q2. In response, a treatment system for Well Q2 was completed in early 2021, and the well is expected to be back online by summer 2022. Additional details on DDW permitting and associated operational timeline for Well 201 are provided in Section 4.7.2.

Well N-13 has remained in service with regular sampling per DDW requirements. Perchlorate concentrations in Well N13 (and Well N12) are currently below the detection limit for reporting (DLR). In 2007, the DPH (currently the DDW) established a maximum contaminant level (MCL) for perchlorate of 6 micrograms per liter ($\mu\text{g/L}$). However, in 2021 DDW lowered the MCL for perchlorate to 2 $\mu\text{g/L}$ and subsequently is in the process of lowering the MCL to 1 $\mu\text{g/L}$ by 2024. Additional details on DDW permitting and associated operational timeline for Well 205 are provided in Section 4.7.2. It is currently assumed that, if required due to changes in future regulations, a centralized treatment system will be installed for Wells N12 and N13 at the Well N12 location.

For Wells Saugus 1 and Saugus 2, DDW has imposed a requirement that perchlorate levels be below the Detection Level for Reporting (DLR) of 2 $\mu\text{g/L}$. These wells are in active service utilizing approved perchlorate treatment and will be treated for VOC's at the Saugus Perchlorate Treatment Facility by 2024.

In August 2010, perchlorate was detected in a sixth Saugus Formation well (Well 201) and was removed from service. Confirmation sampling in the months that followed confirmed the detection of perchlorate at concentrations that ranged from 5.7 to 12 $\mu\text{g/L}$. A perchlorate treatment system is currently installed for Well V-201 and SCV Water recently determined it will also install treatment for VOCs at Well 201. SCV Water is working with DDW to finalize a permit for operation of that treatment systems for both perchlorate and VOCs. Based on the current schedule, the well may come back online by 2024.

Following the detection of perchlorate in Well 201 in 2010, pumping from a nearby Saugus Formation well (Well 205) was minimized to reduce potential perchlorate migration. In April 2012, Well 205 was voluntarily taken out of service entirely when perchlorate was detected in low concentrations below the DLR ($<4.0 \mu\text{g/L}$). As of the date of this report, planning and CEQA activities for Well 205 treatments are in progress. This planning includes provisions for treatment of VOCs should testing determine those constituents are present in concentration sufficient to warrant treatment. The completion of a treatment system for Well 205 is anticipated to occur by early 2024. To date, perchlorate has been detected in a total of nine wells, seven located in the Saugus Formation and two in the Alluvium. Table 4-1 summarizes the current remediation status of all wells where perchlorate has been detected.

Long-term efforts toward the remediation of perchlorate contamination since first detected in 1997 continue to this day. The objective of the perchlorate restoration and containment plan has been to stop the migration of the contaminant plume and restore lost well capacity through pump and treat methods and replacement wells. The following discussion is provided to illustrate the work that has occurred over the last 20 years to reactivate the impacted Saugus 1 and Saugus 2 groundwater supply wells, and that has been expanded to include Wells 201 and 205. SCV Water's Saugus Perchlorate Treatment Facility has been online since 2011, treating Wells Saugus 1 and Saugus 2.

A second Perchlorate Treatment Facility came online in 2017 at Well 201. Until the facility is permitted, treated Water from Well 201 is blended with other SCV Water sources to meet sulfate discharge standards then discharged to the Santa Clara River, under a National Pollutant Discharge Elimination System (NPDES) discharge permit, where it recharges the alluvial aquifer. In 2021 the facility was taken off-line while maintenance was performed. The well and perchlorate treatment facility is anticipated to be placed back into service once the availability of blend water is assessed for 2022, and discharges to the Santa Clara River would then be resumed until DDW approval is acquired for both perchlorate and VOCs. The well is anticipated to be returned to service by early 2024.

The groundwater model that was developed for use in analyzing the operating yield and sustainability of groundwater in the Basin was also used to analyze the capture and control of perchlorate contamination in the originally impacted Saugus wells. As part of the evaluation of the containment system’s effectiveness, the Basin groundwater model was updated and recalibrated using actual pumping data (see LSCE & GSI, 2009). The updated model was also utilized in 2014 and 2015 to evaluate restoration and containment options and select the preferred approach to contain the migration of perchlorate downgradient of the Whittaker-Bermite site and restore Wells 201 and 205 to service (GSI and LSCE, 2014).

In addition to the offsite containment and restoration activities, significant work has continued at the Whittaker-Bermite facility to advance a Saugus Aquifer Containment and Extraction Program. To date the following efforts have been made. A Work Plan, Saugus Aquifer Pilot Remediation Well Network, OU7 was approved on December 31, 2008; and subsequently, implementation of the Work Plan started. A multi-layer groundwater flow model was developed to simulate various groundwater pumping scenarios for capture of impacted groundwater in the Saugus Aquifer beneath the site and the surrounding areas. The optimum number and locations of extraction wells were determined based on the modeling scenarios, and the extraction wells and performance monitoring wells were installed.

Construction of the Saugus Aquifer Treatment Plant (SATP) was completed and operation of the pump and treatment system started in August 2017. The SATP includes liquid granular activated carbon (LGAC) for removal of VOCs and a fluidized bed reactor (FBR) for biological treatment of perchlorate in extracted groundwater. The treated water is discharged to the Santa Clara River, in full compliance with provisions of the NPDES permit issued by the Los Angeles RWQCB. Treated water discharged to river percolates through the riverbed and recharges the alluvial aquifer beneath the riverbed.

Approximately 446,741,200 gallons of water have been treated and discharged since start-up.

**TABLE 4-1
STATUS OF IMPACTED WELLS**

Year Perchlorate Detected	Well	Groundwater Aquifer	Status
1997	Saugus 1	Saugus	DPH (now DDW) approved well return to service in January 2011; well in active service utilizing approved perchlorate treatment.
1997	Saugus 2	Saugus	DPH (now DDW) approved wells return to service in January 2011; well in active service utilizing approved perchlorate treatment.
1997	Well 157	Saugus	Sealed and capacity replaced by new well.

Year Perchlorate Detected	Well	Groundwater Aquifer	Status
1997	Well N11	Saugus	Out of service.
2002	Stadium Well	Alluvium	Sealed and capacity replaced by new well.
2005	Well Q2	Alluvium	Due to perchlorate detection again in 2019, a treatment system was completed in early 2021 and the well is expected to be back online by summer 2021.
2006	Well N13	Saugus	Regular DDW monitoring, concentrations currently below DLR; well remains in service.
2010	Well 201	Saugus	A perchlorate treatment system was installed in 2017 and treated water discharged to Santa Clara River beginning in 2018. Design for VOC treatment facility underway. The treated groundwater from the well may be used for supply by the end of 2024.
2012	Well 205	Saugus	Voluntarily out of service. Planning for treatment at Well 205 in progress with estimated well restoration by 2024.
2022	N-Well	Alluvium	Due to perchlorate detection in 2022, the existing PFAS treatment facility will require an amendment to the Operation Permit. No physical changes to the treatment facility will be required; well remains in service.

Saugus 1 and Saugus 2

In 2002 SCV Water and the U.S. Army Corps of Engineers (ACOE) signed a cost-sharing agreement for a feasibility study of the area. Under federal and state law, the owners of the Whittaker-Bermite property have the responsibility for the groundwater cleanup. SCV Water and the Department of Toxic Substances Control (DTSC) signed an oversight agreement in 2003 (amended in 2012) regarding studies of treatment technologies for removing perchlorate from water supplies, and also worked with DDW to obtain the necessary permits for these treatment processes. Treatment method pilot studies were conducted during 2003, and in 2004 SCV Water and the purveyors selected ion exchange as the preferred treatment method for removing perchlorate.

Although that agreement expired in January 2005 the parties, under DTSC oversight, jointly developed a plan to “pump and treat” contaminated water from two of the purveyors’ impacted wells to stop migration of the contaminant plume and to partially restore the municipal well capacity that had been impacted by perchlorate. The containment plan specified that wells Saugus 1 and Saugus 2 operate at an initial continuous pumping rate of 1,100 gpm (1,772 AFY) at each well, for a combined total of 2,200 gpm (3,544 AFY) from the two wells. The annual pumping volume of 1,772 AFY per well assumes that pumping will occur continuously, except for occasional maintenance purposes.

A final settlement to fund, remediate and treat the contaminated water was completed and executed by the parties in April 2007. Construction of the treatment facility and pipelines began in November 2007 and treatment of the water began in 2010. Water from Wells Saugus 1 and Saugus 2 was initially treated and discharged into the Santa Clara River. DDW issued an amendment to the Operating Permit in December

2010, and the wells were placed back in water supply service in January 2011. Since then, SCV Water has included this water as part of its supply and has been delivering this water to purveyors.

Wells 201 and 205

While a recommendation plan was submitted to restore Well 201 to service that utilized funding from the Whittaker Corporation and its insurer for installing wellhead treatment for contaminated water from Well 201, it has subsequently been determined that treatment for VOCs at well 201 is necessary. SCV Water has initiated design of this additional treatment at Well 201 as well as initiating design for perchlorate treatment and VOC treatment at Well 205. During the time Wells 201 and 205 have been removed from service, the temporary loss of capacity was made up for from the remaining, non-impacted Saugus production facilities and imported water supplies. Restoration of Well 201, operation of Well 205, and new Saugus well construction to replace lost capacity and to expand production capacity from the Saugus Formation are planned to achieve target Saugus Formation capacity through single and multiple dry years as discussed in Section 3.3.

Returning the impacted Saugus well (Well 201) to municipal water supply service after installing treatment requires DDW approval before the water can be considered potable and safe for delivery to customers. The permit requirements are contained in Process Memo 97-005 for direct domestic use of impaired water sources.

Before issuing a permit to a water utility for use of an impaired source as part of the utility's overall water supply permit, DDW requires that studies and engineering work be performed to demonstrate that pumping the well and treating the water will be protective of public health for users of the water. The Process Memo 97-005 requires that DDW review the water utility's plan, establish appropriate permit conditions for the wells and treatment system, and provide overall approval of returning the impacted wells to service for potable use.

The Process Memo 97-005 requires, among other things, the completion of a source water assessment for the impacted well intended to be returned to service. The purpose of the assessment is to determine the extent to which the aquifer is vulnerable to continued migration of perchlorate and other contaminants of interest from the Whittaker-Bermite site. The assessment was completed and initially submitted to DDW for approval in 2015. The assessment includes the following:

- Delineation of the groundwater capture zone caused by operating the impacted wells.
- Identification of contaminants found in the groundwater at or near the impacted wells.
- Identification of chemicals or contaminants used or generated at the Whittaker-Bermite facility.
- Determination of the vulnerability of pumping the impacted wells to these contaminant sources.

A perchlorate treatment system is currently installed for Well 201 and planning for VOC treatment has been initiated. The well is expected to be back online for domestic use by early 2024. Well 205 is also subjected to Process Memo 97-005 and planning for treatment at Well 205 is in progress with an estimated well restoration date by 2024, as shown in Table 4-1. Additional details on DDW permitting and associated operational timeline for Wells 201 and 205 are provided in Section 4.7.

Ultimately, restoration plans and the DDW requirements are intended to ensure that the water introduced to the potable water distribution system has no detectable concentration of perchlorate and all water currently discharged from the potable water distribution system complies with all applicable drinking water standards.

4.2.2 Per- and Polyfluoroalkyl Substances (PFAS)

Per- and polyfluoroalkyl substances (PFAS) are a group of man-made chemicals that have been utilized in a wide array of industrial processes, including among others, production of stain- and water-resistant fabrics, cookware, food packaging, and fire-fighting foams. Among the nearly 5,000 types of PFAS, the two long-chained PFAS, perfluorooctane sulfonate (PFOS) and perfluorooctanoic acid (PFOA) have been produced in the largest amounts. While the use of PFAS has been reduced since the early 2000s, PFOS and PFOA are persistent in the environment and resistant to typical environmental degradation processes which has led to their accumulation and widespread contamination of natural resources, including groundwater supplies.

Recently, the United States Environmental Protection Agency (USEPA) implemented a new lifetime health advisory level of 70 parts per trillion (or 70 nanogram per liter [ng/L]) for the combined concentrations of PFOA and PFOS in drinking water. In August 2019, DDW set a notification level (NL) of 5.1 and 6.5 ng/L for PFOA and PFOS, respectively. Subsequently, in February 2020, the DDW set a response level (RL) of 10 ng/L for PFOA and 40 ng/L for PFOS, based on a running annual average (RAA). RL is the concentration at which DDW recommends that a well is taken out of service, pending treatment. If a chemical concentration is greater than its NL (but below the RL) in drinking water that is provided to consumers, DDW recommends that the utility inform its customers and consumers about the presence of the chemical, and about health concerns associated with exposure to it. Potential regulatory limits for several short chain PFAS compounds are currently undecided.

On February 22, 2021, USEPA published a notice in the federal register that the agency is in the process of developing a MCL for PFAS under the federal Safe Drinking Water Act. At this time, it is unclear whether the federal MCL will match the health advisory level of 70 parts per trillion, or if it will be a lower level, similar to the RL adopted DDW. SCV will monitor EPA's regulatory decisions and comply with all applicable requirements. Groundwater delivered by SCV to ratepayers will need to be treated to ensure it meets Safe Drinking Water Act standards, if the groundwater contains PFAS at levels that exceed the MCL

In accordance with an Order issued by DDW in March 2019, SCV Water was required to sample 15 wells for four consecutive quarters for PFAS. Initial quarterly samples were collected in May 2019 and one well (Valley Center), exceeded the EPA RL of 70 ng/L for combined levels of PFOA and PFOS and the well was immediately taken out of service. In addition, 10 of the initial 15 wells sampled exceeded one or both NLs for PFOS and PFOA. Public notification was provided to the SCV Water Board of Directors, the Santa Clarita City Council and Los Angeles County Board of Supervisors. At this time, SCV Water decided to voluntarily sample all wells quarterly for PFAS. PFOA and/or PFOS levels higher than NLs and RLs were observed in over 60% of the wells. Subsequent public notifications were provided to SCV Water customers, and one well that was found to exceed the RL was immediately taken out of service. In response to the revised RL from February 2020, SCV Water proactively shutdown numerous wells that were anticipated to exceed the RAA for either PFOA or PFOS.

The preparation of a Groundwater Treatment Implementation Plan was initiated in 2020 with the purpose of evaluating the feasibility and costs of PFAS and perchlorate treatment options (Kennedy Jenks 2021). A total of 28 existing SCV Water wells were identified to be impacted by PFAS, being wells showing representative values of PFOA and PFOS above 80% of the DDW RLs. Based on preliminary results of the alternatives analysis, ion exchange was identified as the preferred treatment option. According to the plan, out of the 28 wells requiring treatment, five wells would have wellhead treatment system and groundwater from the remaining wells would be treated at eight centralized treatment locations. To date,

one centralized treatment system was completed for the three N-wells (N, N7 and N8). Restoration of the remaining wells is estimated to occur between 2022 and 2030 as described further in Section 3 and the Santa Clarita Valley Water Agency, Groundwater Treatment Implementation Plan Technical Memorandum (Kennedy Jenks 2021).

4.2.3 Metals and Salts

Metals and salts are tested in wells at least every three years and in Castaic Lake water every month. Concentrations of arsenic at levels less than the drinking water standard of 0.01 milligrams per liter that occur naturally from geologic materials are found in Castaic Lake and in a few wells. Inorganic compounds such as salts and metals can be naturally occurring or result from urban storm water runoff, industrial or domestic wastewater discharges, oil and gas production, mining, or farming. Arsenic levels in the Santa Clarita Valley have regularly been below the MCL (10 ug/L) and oftentimes below the DLR (2 ug/L), as was the case during 2019 monitoring (LSCE, 2020).

Nitrate in drinking water at concentrations above 45 mg/L is a health risk for infants less than six months of age due to the possibility of methemoglobinemia. Nitrate levels may rise quickly for short periods of time because of rainfall or agricultural activity. Principal sources of nitrogen to a watershed typically include discharges from water reclamation plants, septic systems, and recharge from agricultural activities. Nitrates are tested at least annually, and the drinking water meets federal and state MCL standards (2020 WQR).

A TMDL for chloride in the Upper Santa Clara River (Reaches 5 and 6) was adopted by the Los Angeles RWQCB and became effective on May 5, 2005. The Basin Plan Amendment for the chloride TMDL in the Upper Santa Clara River was unanimously adopted by the Los Angeles RWQCB on December 11, 2008. The TMDL identifies the Valencia and Saugus WRPs as the largest sources of chloride to the Upper Santa Clara River and established waste load allocations of 100 mg/L for the Saugus and Valencia WRPs. In 2014, the Los Angeles RWQCB adopted the most recent version of the USCR Chloride TMDL, Resolution R4-2014-010, which incorporated special study findings and assigned waste load allocations of less than 150 mg/L as a 3-month rolling average at the Saugus, and less than 100 mg/L as a 3-month rolling average for the calculated “combined effluents” of the Saugus and Valencia WRPs.

In response to the adopted chloride TMDL, the SCVSD developed a chloride compliance plan that includes source control, construction of UV disinfection facilities at the Saugus and Valencia WRPs, and construction of the AWTF at the Valencia WRP. The AWTF will help meet the chloride TMDL and is anticipated to be completed by 2022.

4.2.4 Disinfection By-Products

SCV Water uses ozone and chloramines to disinfect its water supply. Disinfection By-Products (DBPs), which include Trihalomethanes (THMs) and Haloacetic Acids (HAA5), are generated by the interaction between naturally occurring organic matter and disinfectants such as chlorine and ozone. THMs and HAA5 are measured at several points throughout the distribution system. Each location is averaged once per quarter and reported as a running annual average.

Ozone is a very powerful disinfectant that not only kills organisms that no other disinfectant can, but also destroys organic chemicals that cause unpleasant tastes and odors. However, ozone can also interact with bromide, a naturally occurring salt, to produce bromate. Bromate is measured weekly in the surface water treatment plant and compliance is based on a running annual average.

4.2.5 Total Trihalomethanes

Total Trihalomethanes (TTHMs) are byproducts created when chlorine is used as a means for disinfection. The Stage 2 Disinfectants and Disinfection Byproducts Rule, implemented by EPA in 2005, requires water systems to apply an MCL of 80 ug/L for TTHM at each compliance monitoring location (instead of as a system-wide average as in previous rules). SCV Water implements a combination of chlorination (using calcium hypochlorite) and chloramination across its system and maintains TTHM levels below the MCL, as documented in the 2020 WQR.

4.2.6 Microbiological

Microbial contaminants, such as viruses and bacteria, can be naturally occurring or result from urban stormwater runoff, sewage treatment plants, septic systems, agricultural livestock operations and wildlife. Water is tested throughout the systems weekly for Total Coliform bacteria and testing for *Escherichia coli* (*E. coli*) occurs when coliform testing is positive. No *E. coli* was detected in any drinking waters in 2019. The MCL for total coliforms is 5 percent of all monthly tests showing positives for larger systems. Bacteriological tests met federal and state requirements. Additional microbiological tests for the water-borne parasites *Cryptosporidium parvum* and *Giardia lamblia* were performed on Castaic Lake water, and none were detected.

4.2.7 Radiological Tests

Radioactive compounds can be found in both ground and surface waters and can be naturally occurring or be the result of oil and gas production and mining activities. Testing is conducted for two types of radioactivity: alpha and beta. If none is detected at concentrations above five picoCuries per liter no further testing is required. If it is detected, the water must be checked for uranium and radium. Although naturally occurring radioactivity can be detected, existing monitoring data indicate that alpha and beta levels are below the federal and state MCL standards.

4.2.8 Organic Compounds

Organic chemical contaminants, including synthetic and volatile organic chemicals, are by-products of industrial processes and petroleum production, and can also come from gas stations, urban storm water runoff and septic systems. Organic compounds also include pesticides and herbicides, which may come from a variety of sources such as agriculture, urban storm water runoff and residential uses. Water is tested for two types of organic compounds, volatile organic compounds (VOCs) and non-volatile synthetic organic compounds (SOCs). These organic compounds are synthetic chemicals produced from industrial and agricultural uses. Castaic Lake water is checked annually for VOCs and SOCs.

Although VOCs tend to escape from surface water through volatilization (evaporation) into the air, once dissolved in groundwater they are more persistent. Local wells are tested at least annually for VOCs and periodically for SOCs. Saugus 1, Saugus 2 and 201 wells are tested up to weekly for VOCs. VOCs have been measured in trace levels in some of the SCV Water wells. Trichloroethylene (TCE) represents the

major VOC constituent detected in these wells. Tetrachloroethylene (PCE) has also been detected in a few samples. However, the measured levels of these constituents in these wells are well below their respective MCLs.

SCV Water's Water Supply Permit for Wells Saugus 1 and 2 sets an operational goal of no VOCs above the DLR (0.5 ug/L) in its distribution system and SCV Water. Over the last 5 years, the operational goal has been achieved in more than 95% of the samples collected. When there are detections, they are well below the MCL and just slightly above the DLR. SCV Water performed a VOC source identification study in July 2015 which concluded that the likely source was the Whittaker-Bermite site. SCV Water is currently working with DTSC to develop additional monitoring requirements for both sites. Supplemental VOC treatment of Saugus 1 and 2 wells is currently in design.

During startup of the Well 201 perchlorate treatment facility, TCE was detected slightly above the DLR. Detections of TCE in Well 201 have ranged from a high of 1.3 ug/L to <DLR. Average detections are slightly above the DLR at around 0.6 ug/L. SCV Water has determined it will supplement the perchlorate treatment facility at Well 201 with a GAC based treatment facility. This additional treatment component is currently under design. In order to bring Well 201 back into potable production, SCV Water will be subject to Process Memo 97-005 requirements. SCV Water anticipates construction and permitting to be completed by 2024. Recognizing the potential for similar challenges at Well 205, initial design incorporates the potential need for treatment of VOCs and the need to meet Process 97-005 requirements. Well 205 is anticipated to become available in 2024.

In order to address contamination at the Whittaker-Bermite site, a remedial action plan (RAP) and associated CEQA document were approved by DTSC on December 2, 2014. The RAP presents an evaluation of identified remedial alternatives for containment and cleanup of impacted groundwater at the Whittaker-Bermite site. In accordance with the RAP, a Saugus Aquifer Treatment Plant was constructed and began operation in August 2017. The treatment plant includes a fluidized bed reactor (FBR) system which provides biological treatment of perchlorate and liquid granular activated carbon which is used to remove VOCs in groundwater. Approximately 446,741,200 gallons of water have been treated since start-up.

4.3 Imported Water Quality

SCV Water provides SWP and other imported water to the Valley. The source of SWP water is rain and snow of the Sierra Nevada, Cascade, and Coastal Mountain ranges. This water travels to the Delta through a series of rivers and various SWP structures. From there it is pumped into a series of canals and reservoirs, which provide water to urban and agricultural users throughout the San Francisco Bay Area and central and southern California. The most southern reservoir on the West Branch of the SWP California Aqueduct is Castaic Lake. SCV Water receives water from Castaic Lake and distributes it to its customers following treatment.

SCV Water operates two water treatment plants, the Earl Schmidt Filtration Plant located near Castaic Lake and the Rio Vista Water Treatment Plant located in Saugus. SCV Water produces water that meets drinking water standards set by the U.S. EPA and DDW. SWP Water has different aesthetic characteristics than groundwater, with lower dissolved mineral concentrations (total dissolved solids) of approximately 250 to 400 mg/L, and lower hardness (as calcium carbonate) of about 105 to 135 mg/L. Historically, the chloride content of SWP Water varies widely from over 100 mg/L to below 40 mg/L, depending on Delta

conditions. In addition, changes in SWP operations, as described below, can also result in water quality variations.

Historically, the SWP delivered only surface water from the Sacramento-San Joaquin River Delta. However, SCV Water along with other SWP contractors have integrated water supply programs also include “water banking” programs where SWP Water is stored or exchanged during wet years and withdrawn in dry years. Withdrawn water can either be delivered by exchange with SWP supplies allocated to others, or by pumping it into the SWP system. During dry periods, a greater portion of water in the SWP includes banked water supplies. The banked water has met all water quality standards established by DWR under its pump-in policy for the SWP. Source water from SCV Water’s Semitropic Bank can require treatment for 123 TCP and arsenic prior to introduction into the Aqueduct depending on the mix of wells used for recovery. To date Semitropic has successfully treated its source water through blending methods and meets DWR pump-in policy. Supplies from SCV Water’s Rosedale Bank have also met DWR pump-in criteria. In general, pumped-in water serves to reduce the chloride concentration in SWP Water. The SWP water chemistry may fluctuate and is influenced by its passage through the Delta, where large amounts of organic material are present and where mixing with salt water from the San Francisco Bay, which contributes bromide and chlorides, may occur. Chloride levels from the Delta elevate chloride locally resulting in concern for local agriculture that grows chloride sensitive crops. Additionally, bromide and TOC may react with disinfectants such as ozone, chlorine, or DBPs. All constituents met the federal and state MCL levels as reported in the 2020 WQR.

4.4 Surface Water Quality

SCV Water does not deliver and treat water from the Santa Clara River as a source of supply; however, this supply is a source of recharge to the underlying groundwater basin.

The Los Angeles RWQCB Basin Plan (Basin Plan, 1994) provides water quality objectives for surface water in the USCR. These objectives were established to protect the various beneficial uses for that particular water body or reach. The water bodies of the USCR Watershed, which include streams, natural lakes, and reservoirs, span a wide variety of existing, potential and/or intermittent beneficial uses. The following is a list of the beneficial uses identified in the USCR:

- Municipal and Domestic Supply
- Industrial Service Supply
- Industrial Process Supply
- Agricultural Supply
- Groundwater Recharge
- Freshwater Replenishment
- Hydropower Generation
- Water Contact and Non-contact Water Recreation
- Warm and Cold Freshwater Habitat
- Wildlife Habitat
- Rare, Threatened, and Endangered Species
- Spawning, Reproduction, and/or Early Development

All of the surface water bodies in the USCR Watershed support the designated beneficial uses (either existing or intermittent) of municipal and domestic supply, agricultural supply, groundwater recharge, water contact recreation, non-contact water recreation, wildlife habitat, and warm freshwater habitat. In addition, many water bodies (such as Bouquet, San Francisquito, and Soledad Canyons) support the designated

beneficial uses (either existing or intermittent) of rare, threatened, or endangered species; wetland habitat; and/or spawning, reproduction, and/or early development.

Regional reservoirs that support hydropower generation include Elderberry Forebay, Castaic Lake, Dry Canyon Reservoir, Bouquet Reservoir, and Pyramid Lake. Local surface waters are not a direct source of drinking water supply in the Region, but they are a continual source of recharge to groundwater which is used to meet municipal water demands.

Based on the 2014 and 2016 California Integrated Report and related Clean Water Act Section 303(d) list, there are a number of impairments identified for Reaches 5, 6 and 7 of the Santa Clara River, and for Lake Hughes, Lake Elizabeth, and Munz Lake, all of which are within the Upper Santa Clara River Watershed.

The Santa Clara River currently has two approved TMDLs due to non-attainment of water quality objectives, one pertaining to chloride (see Section 4) and another pertaining to bacteria. Another TMDL is in place for three lakes within the Region that are impaired with trash. Other pollutants impacting local surface waters include nutrients, metals, pesticides, and others.

Surface water quality is monitored in numerous locations throughout the Valley. Continuous sampling records are taken at two gaging stations at the Old Highway 99 Bridge and at the Los Angeles-Ventura County Line ("Blue Cut").

4.5 Groundwater Quality

The groundwater basin has two sources of groundwater, the Alluvial Aquifer whose quality is primarily influenced by recharge from rainfall and stream flow, and the Saugus Formation, which is a much thicker aquifer and recharged primarily by a combination of rainfall and deep percolation from the partially overlying Alluvium. A larger part of the Valley's groundwater supply is from the Alluvial Aquifer, between 30,000 to 40,000 AFY; and a smaller portion of the Valley's water supply is drawn from the Saugus Formation, with a target production level between 7,500 and 15,000 AFY in normal water years.

Local groundwater does not have microbial water quality problems. Parasites, bacteria, and viruses are filtered out as the water percolates through the soil, sand, and rock on its way through the vadose zone to the water table (the top of the aquifer). Even so, disinfectants (hypochlorite) are added to local groundwater when it is pumped by wells to protect public health. Local groundwater has very little TOC and generally has very low concentrations of bromide, minimizing potential for DPB formation. Taste and odor problems from algae are not an issue with groundwater.

The mineral content of local groundwater is very different from SWP water. The groundwater is very "hard," and it has high concentrations of calcium and magnesium (approximately 250 to 600 mg/L total hardness as CaCO₃). Groundwater may also contain higher concentrations of nitrates and sulfates when compared to SWP water. However, all groundwater meets drinking water standards.

4.5.1 Water Quality – Alluvium

Groundwater quality is a key factor in assessing the Alluvial Aquifer as a municipal and agricultural water supply. Groundwater quality details and long-term conditions, examined by integration of individual records from several wells completed in the same aquifer materials and in close proximity to each other, have been discussed previously in the annual Water Reports and in the 2020 UWMP. Historical groundwater quality as represented by TDS (which is a measure of the amount of dissolved minerals and salts in water expressed in mg/L) from representative wells in the Valley have been reviewed relative to DDW Secondary

4-12

Maximum Contaminant Levels (SMCL) (Recommended, Upper and Short-term Levels). While concentrations of TDS generally respond to wet periods by exhibiting a downward trend, followed by an increasing trend during a dry period, the historical TDS data does not exhibit a long-term increasing trend and, therefore, no long-term decline in Alluvial groundwater quality. In general, groundwater quality exhibits a “gradient” from east to west, with lowest dissolved mineral content to the east, increasing in a westerly direction; and periodic fluctuations in some parts of the basin, where groundwater quality has inversely varied with recharge from precipitation and stream flow. Those variations are typically characterized by increased mineral concentrations through dry periods of lower stream flow and lower groundwater recharge, followed by lower mineral concentrations through wetter periods of higher stream flow and higher groundwater recharge.

Overall, water quality analyses demonstrate that, with the exception of occasional variances above the SMCL for TDS, groundwater of the Alluvium meets acceptable drinking water standards. The presence of long-term consistent water quality patterns, although intermittently affected by wet and dry cycles, supports the conclusion that the Alluvial aquifer is a viable ongoing water supply source in terms of groundwater quality.

The most notable groundwater quality issue in the Alluvium is PFAS contamination, described in Section 4.2.2.

4.5.2 Water Quality – Saugus Formation

As discussed above for the Alluvium, groundwater quality is a key factor in also assessing the Saugus Formation as a municipal and agricultural water supply. Long-term Saugus groundwater quality data is not sufficiently extensive to permit any sort of basin-wide analysis or assessment of pumping-related impacts on quality. However, integration of individual records from several wells has been used to examine general water quality trends. Based on those records, water quality in the Saugus Formation has not historically exhibited the precipitation-related fluctuations seen in the Alluvium. Based on available data over the last fifty years, groundwater quality in the Saugus has exhibited a slight overall increase in dissolved mineral content. Between 2000 and 2005, several wells within the Saugus Formation exhibited an increase in TDS concentrations, similar to the short-term changes in the Alluvium, possibly as a result of recharge to the Saugus Formation from the Alluvium. Between 2006 and 2010, these concentrations steadily declined, followed by an increasing trend through 2016 and decreasing trend through 2019, except for Well N12 which remained stable.

TDS concentrations in the Saugus Formation remain within the range of historic concentrations and below the (aesthetic) MCL upper level. Groundwater quality within the Saugus will continue to be monitored to ensure that degradation which could present concern relative to the long-term viability of the Saugus as an agricultural or municipal water supply does not occur.

The most notable groundwater quality issues in the Saugus Formation are perchlorate and VOC contamination.

4.6 Water Quality Impacts on Reliability

Three factors affecting the availability of groundwater are sufficient source capacity (wells and pumps), sustainability of the groundwater resource to meet pumping demand on a renewable basis and protection of groundwater sources (wells) from known contamination, or provisions for treatment in the event of contamination. The resolution of contamination for aquifer protection is addressed below.

Among the main constituents of concern with potential to impact groundwater availability are perchlorate, VOCs and PFAS. Based on the low levels of detection and blending practices with imported water supplies, VOCs are not anticipated to impact groundwater supply availability or reliability. Additionally, TCE detected at the Well 201 perchlorate treatment facility will be addressed as part of the Process Memo 97-005 DDW drinking Water permitting process. New standards for PFAS and subsequent testing results have indicated groundwater impacts in the Alluvial Aquifer from this constituent group and resulted in SCV Water’s decision to shut down several wells in the recent past.

Perchlorate has been a water quality concern in the Valley since 1997 and long-term efforts are ongoing for the containment and remediation of perchlorate contamination. Currently, efforts are focused on stopping the migration of the contaminant plume and restoring the lost well capacity through pump and treat methods. SCV Water has sealed and replaced the capacity of some perchlorate impacted wells with new wells, and it has treated some of the wells and brought them back online. Some impacted wells are subjected to impaired water (97-005) compliance requirements, while others are currently in operation with a DDW approved monitoring program. Additionally, other perchlorate-impacted wells are currently offline awaiting installation (or permit) of treatment process. As noted above, two perchlorate treatment facilities have come online since 2011 and a third system was completed in early 2021.

Recognizing the existing water quality issues that affect the local groundwater, from perchlorate and VOCs, and more recently PFAS, SCV Water has developed a groundwater treatment and implementation plan (Kennedy Jenks 2021) to improve the reliability of its local groundwater supplies and ensure suitable water quality for meeting its customer potable demands. It is understood that groundwater treatment and implementation must be developed consistent with SCV Water’s GSP, such that any relevant information pertaining to the adequacy, availability, and sustainability of supplies be consistent with the GSP and GSP implementation Plan.

Overall, the plans being developed for groundwater operation will allow SCV Water to meet near term and long-term demand within the SCV Water service area. The loss of capacity of wells impacted by water quality issues and removed from service in the near term will be met by near-term excess capacity in non-impacted wells, other water sources including imported water supplies, and/or through the installation of replacement well(s), if necessary, until remediation alternatives, including wellhead treatment, and DDW approval is obtained for restoration of the impacted supply. Therefore, no anticipated change in reliability or supply due to water quality is anticipated based on the present data, as is shown in Table 4-2.

**TABLE 4-2
CURRENT AND PROJECTED WATER SUPPLY CHANGES DUE TO
WATER QUALITY (PERCENTAGE CHANGE)**

Water source	2020	2025	2030	2035	2040	2045	2050
Groundwater							
Alluvial ^(a)	63%	25%	0%	0%	0%	0%	0%
Saugus ^(b)	25%	0%	0%	0%	0%	0%	0%
Imported Water	0%	0%	0%	0%	0%	0%	0%
Recycled Water	0%	0%	0%	0%	0%	0%	0%
Banking Programs	0%	0%	0%	0%	0%	0%	0%

Notes:

(a) Based on 24,170 AFY and 25,660 AFY being available to SCV Water in 2020 and 2025 respectively and calculated for normal years. Net reduction in Alluvial pumping is 15,270 and 6,420 in 2020 and 2025, respectively. Full Alluvial well capacity is restored by 2030 per groundwater treatment and implementation plan (Kennedy Jenks 2021). As discussed, this interim reduction in supply does not result in an overall supply shortfall.

(b) Based on forgone pumping capacity of 5,950 for well 201 and 205 per Table 4-8C (provided in the 2020 UWMP and at total pumping capacity of 23,930 AFY (14,980 existing capacity + 5,950 of recovered capacity). As discussed, this interim reduction in supply does not result in an overall supply shortfall.

4.7 Review of Pending Water Quality Permitting for Saugus Wells

Based on the anticipated process for water quality permitting and current status, this section provides information supporting the proposed timeline for operation of existing Saugus wells 201, 205, and future additional Saugus wells (Saugus 3 and 4, Saugus 5 and 6, and Saugus 7 and 8) following DDW water quality permitting requirements as summarized in Table 4-3.

**TABLE 4-3
ANTICIPATED SCHEDULE FOR PERMITTING AND OPERATION OF SAUGUS WELLS**

Well	Well Status	Treatment Status	DDW Permit Requirements	DDW Permit Status	Anticipated Schedule
201	Existing and operating (discharge to surface water)	Perchlorate treatment since 2017	97-005 Process Memo	<ul style="list-style-type: none"> - Pending revised 97-005 documentation sections (most information from previous submittal is applicable) and DDW sequential review - Pending water supply permit amendment application and public hearing - Pending revised CEQA 	<ul style="list-style-type: none"> - 2021: CEQA - December 2021: Treatment design completed - Q12022: draft 97-005 documentation sections 1-5 and sequential DDW review/approval - 3Q2022 – 4Q2023: System construction - 3Q-4Q2023: Startup testing and submittal of testing data to DDW - 1Q2024: DDW review and approval of 97-005 draft documentation and ancillary documents - 2Q2024: Water supply permit application - 3Q2024: Public Hearing - 4Q2024: Water supply permit application Amended Water Supply Permit and Operation (as applicable)

Well	Well Status	Treatment Status	DDW Permit Requirements	DDW Permit Status	Anticipated Schedule
205	Existing and not operating	Preliminary design complete	97-005 Process Memo	<ul style="list-style-type: none"> - Pending draft 97-005 documentation sections (most information from Well 201 documentation is applicable) and DDW sequential review - Pending water supply permit amendment application and public hearing - Pending CEQA 	<ul style="list-style-type: none"> - 2022: CEQA - 2022: Treatment design - 2023: draft 97-005 documentation sections 1-5 and sequential DDW review/approval - 1Q2023 – 1Q2024: System construction - 1Q-4-Q2024: Startup testing and submittal of testing data to DDW - 1Q2024-2Q2024: DDW review and approval of 97-005 draft documentation and ancillary documents - 1Q2024-Q22024: Water supply permit application - 3Q2024: Public Hearing - 4Q2024: Water supply permit application Amended Water Supply Permit and Operation (as applicable)
Saugus 3 and 4	Designed and drilling pending DDW permit	Not applicable, it is anticipated that technical documents to address some elements of 97-005 process memo may be required by DDW because of proximity of abandoned oilfield but treatment will not be required	Drinking Water Source Assessment Plan	<ul style="list-style-type: none"> - Preliminary Drinking Water Source Assessment Plan complete - Pending submittal and DDW review of Drinking Water Source Assessment Plan - CEQA completed and approved in 2005 	<ul style="list-style-type: none"> - 4Q2021-2Q2022: Draft Drinking Water Source Assessment Plan and DDW review and drilling approval - Q12022-Q2022 CEQA - 3Q2022 – 3Q2024: Well installation and testing - 2025: Amended Water Supply Permit
Saugus 5 and 6	Locations identified and secured	Anticipated not applicable	Drinking Water Source Assessment Plan	<ul style="list-style-type: none"> - Pending draft Drinking Water Source Assessment Plan and DDW review (anticipated) 	<ul style="list-style-type: none"> - 2022-2023: Draft Drinking Water Source Assessment Plan, and DDW

Well	Well Status	Treatment Status	DDW Permit Requirements	DDW Permit Status	Anticipated Schedule
				that wells are not subject to Process Memo 97-005) - Pending CEQA	review and drilling approval - 2023: CEQA - 2024: Wells installation and testing - 2025-2027: Amended Water Supply Permit
Saugus 7 and 8	Locations TBD	Anticipated not applicable	Drinking Water Source Assessment Plan	- Pending draft Drinking Water Source Assessment Plan and DDW review (anticipated that wells are not subject to Process Memo 97-005) - Pending CEQA	- 2021-2023: Location identifications - 2024 Draft Drinking Water Source Assessment Plan and DDW review and drilling approval - 2024: CEQA - 2025-2026: Wells installation and testing - 2027-2030: Amended Water Supply Permit
N-Well	Existing and Operating	Treated for PFAS since 2020	Operating Permit Amendment	- Processing Amendment to Operating Permit to include perchlorate treatment at the existing PFAS Treatment Facility	- 2022: Operating Permit Amended

4.7.1 Process Memo 97-005 Requirements

Operation of Saugus wells 201 and 205 for drinking water supply will require an amended Water Supply Permit subjected to Process Memo 97-005 for direct domestic use of extremely impaired sources. Based on the revised Process Memo 97-005-R2020 issued by DDW in September 2020, the following studies and documents are required prior to DDW issuance of the water supply permit:

- Process Memo 97-005 documentation, including the following elements:
 - Drinking Water Source Assessment and Contaminant Assessment
 - Full Characterization of Raw Water Quality
 - Drinking Water Source Protection
 - Effective Treatment and Monitoring
 - Evaluation of Human Health Risks Associated with the Failure of the Proposed Treatment
 - Operations Maintenance and Monitoring Plan
- CEQA documentation
- Water supply permit application
- Treatment facility compliance/startup testing plan
- Startup testing data and documentation
- Public hearing

The process outlined by DDW in the revised Process Memo 97-005-R2020 is as follows:

- The water purveyor prepares and submits draft Process Memo 97-005 documentation sections to DDW
- DDW review and provide written approval of the draft Process Memo 97-005 documentation sections sequentially
- The water purveyor completes startup testing of the treatment facility and submits testing data for DDW review and approval
- The Process Memo 97-005 documentation is deemed complete by DDW, including written approval of each section
- The water purveyor applies for an amended Water Supply Permit
- The Process Memo 97-005 documentation and ancillary documents are provided for public review
- DDW and the water purveyor hold a public hearing
- DDW determine whether to issue the amended Water Supply Permit for the extremely impaired source

The anticipated schedule for operation of the Saugus wells has been determined based on the requirements and process outlined above and the current status.

4.7.2 Existing and Future Saugus Wells

4.7.2.1 Saugus Well 201

SCV Water had completed the draft Process Memo 97-005 documentation for Saugus well 201, including collection and documentation of operational data since the system started operating with discharge to surface water in 2017, however a review of submitted information in light of SCV Water's decision to incorporate VOC treatment is underway. While CEQA has been completed for the original project, supplemental documentation may need to be provided to DDW for the additional VOC treatment for the well. Well 201 is anticipated to return to service in 2024.

4.7.2.2 Saugus Well 205

Well 205 is located in the vicinity of Well 201, and evaluation of the anticipated capture zone under different operating conditions has been completed (GSI and LSCE 2014). Because of the close proximity of Well 205 to Well 201 and the similarity of the anticipated wellhead treatment, it can be assumed that significant portions of the draft Process Memo 97-005 documentation for Well 201 will be applicable to Well 205, including:

- Drinking Water Source Assessment and Contaminant Assessment
- Drinking Water Source Protection
- Effective Treatment and Monitoring
- Operations Maintenance and Monitoring Plan

The preliminary design for the treatment system is complete and the final design is anticipated to be completed by the end of 2022. Following completion of the final design, it is anticipated that SCV Water will prepare the draft Process Memo 97-005 documentation in 2023 in close collaboration with DDW, including sequential review of draft sections and requirement of written approval. Treatment system construction and testing is anticipated in 2023-2024, and completion of Process Memo 97-005 documentation, DDW review, and public hearing is anticipated in 2024.

4.7.2.3 Saugus Wells 3 and 4

Sites for Saugus wells 3 and 4 have been identified and secured. The sites are located within approximately 2,500 feet of abandoned oilfield wells. SCV Water has been in communication with DDW about these well locations. Based on these communications and the descriptions of “extremely impaired source” in the revised Process Memo 97-005-R2020, it is not anticipated that Saugus wells 3 and 4 will be subject to Process Memo 97-005. SCV Water has provided the following information to DDW to confirm this assumption:

- Description of the local hydrogeology and drinking water well design information
- Drinking Water Source Assessment Plan
- Water quality data from monitoring wells located within the anticipated capture area

Drilling approval has been given by DDW, well installation and testing are anticipated in late 2022-early 2024 with permits in late 2024. Wells are anticipated to return to service in 2025.

4.7.2.4 Saugus Wells 5 and 6

Sites for Saugus wells 5 and 6 have been identified and secured in the Castaic Junction area. Based on the descriptions of “extremely impaired source” in the revised Process Memo 97-005-R2020, it is not anticipated that Saugus wells 5 and 6 will be subject to Process Memo 97-005. Similar to Saugus wells 3 and 4, it is anticipated that SCV Water will provide the following information to DDW prior to well installation:

- Description of the local hydrogeology and drinking water well design information
- Drinking Water Source Assessment Plan
- Water quality data from monitoring wells located within the anticipated capture area

Following review and drilling approval by DDW, well installation and testing are anticipated in 2027.

4.7.2.5 Saugus Wells 7 and 8

Sites for Saugus wells 7 and 8 have not been identified. Therefore, the schedule for operation of those wells for drinking water supply is anticipated for 2030.

4.7.2.6 N-Well

SCV Water is in the process of having the Operation Permit for the existing PFAS Treatment Facility for the N-Well amended by DDW to include monitoring and language to include perchlorate treatment. The current ion exchange treatment for PFAS treats for perchlorate as well and only minor operational changes are needed. There will be no changes to the Facility.

4.8 Potential Effects of Climate Change

A topic of increasing importance for water planners and managers is climate change and the potential impacts it could have on California’s future water supplies. With a range of potential scenarios and impacts, climate change increases uncertainty of future demand conditions and local and imported water supply conditions thereby posing additional water management challenges.

California is described as one of the most “climate-challenged” regions in North America, in the Fourth Climate Change Assessment (Climate Assessment) (<https://nca2018.globalchange.gov/>), completed in 2018 in coordination with the CEC, CNRA and State Office of Planning and Research. This Climate

Assessment includes updated climate projections and supports findings that the State will experience greater impacts from climate change in the future, including shifting hydrology. Among the technical reports prepared for the Climate Assessment is a report on the *Mean and Extreme Climate Change Impacts on the State Water Project* (Wang et al., 2018).

Primary climate change impacts projected by global climate models to impact the State and Santa Clarita Valley region include warming air temperatures and changes in precipitation patterns, with more frequent and intense heavy precipitation events on the one hand and more frequent and more severe droughts on the other hand, among other impacts. While studies related to the region are conclusive regarding the anticipated increase in extreme events, there is disagreement whether average precipitation changes will be towards wetter or drier conditions. Impacts outside the Santa Clarita Valley, but nevertheless of high importance, include rising sea levels and declining snowpack. These conditions impact the availability and reliability of both local and imported water supplies.

Recent findings indicate that higher temperatures will lead to dryer conditions, and an increased occurrence of dry years and multiple dry years resulting in more frequent and more intense droughts. Drought risks are anticipated to be some of the greatest vulnerabilities to water supplies and demands, resulting in among other things reductions in groundwater recharge, reduced runoff, and surface water flows, and reduced local and imported water supply reliability. Additionally, warmer temperatures and changes in precipitation patterns are anticipated to result in increasing water needs as discussed in the following reports:

- Upper Santa Clara River Integrated Regional Water Management Plan
- City of Santa Clarita Climate Action Plan
- Los Angeles Countywide Sustainability Plan
- State Water Project Delivery Capability Report
- California's Fourth Climate Change Assessment
- SCV-GSA Groundwater Sustainability Plan

Climate Change was incorporated into the 2020 UWMP and reflected in this WSA. To accomplish this, an estimate of how 2050 climate is likely to differ compared to baseline normal climate. These estimates are obtained from the climate change scenarios and supporting data that DWR has made available for assessing groundwater basin sustainability to support implementation of the Sustainable Groundwater Management Act (SGMA). This is the same information that GSI Water Solutions used in preparing the GSP. (GSI Water Solutions, Inc. (2020) and the development of a Numerical Groundwater Flow Model for the Santa Clara River Valley East Groundwater Subbasin. These estimates were selected to remain consistent with climate change scenarios used for evaluating supply impacts as recommended by the DWR UWMP Guidebook. Climate change conditions for SWP supplies were incorporated consistent with DWR's 2019 SWP Delivery Capability Report.

Section 2 of the 2020 UWMP present demands used in this WSA. A more detailed discussion regarding demand development including climate change can be found in UWMP's Appendix F: Population and Demand Technical Memorandum (Maddaus) with the climate change methodology presented in Appendix F of the Maddaus report.

The approach uses the Department of Water Resources (2018a) Guidance for Climate Change Data Use During Groundwater Sustainability Plan Development. In the resource, DWR provides downscaled, gridded information about expected percentage changes in reference ETo and precipitation for two different time horizons (i.e., year 2030 and 2070). Each grid is roughly 6 kilometers by 6 kilometers in area,

allowing for a granular assessment of local conditions. These change factors are derived as the average of 20 climate model predictions for each horizon year. These 20 climate models were selected by DWR’s Climate Change Technical Advisory Group in 2015 as best representing California.

The gridded change factors are provided as a climatological time series by month and year between 1915 and 2011. It is meant to capture how historical weather during the 1915-2011 period in a grid would have been different under expected climate conditions in 2030 and 2070. This format allows groundwater modelers to simulate water budgets under alternative scenarios, such as actual historical weather, or historical weather modified by the change factors to reflect expected 2030 or 2070 weather conditions.

This simulation approach preserves historical inter-annual weather variability, allowing for an apples-to-apples comparison across the simulation of alternative scenarios. To capture expected future weather conditions in the Santa Clarita Valley, change factors for reference ETo and precipitation were downloaded for the two grids that cover the SCV Water service area and averaged.

Figure 4-1 shows monthly factors by which reference ETo is expected to be relatively higher in both the year 2030 and year 2070. Figure 4-2 shows the same for precipitation. Change factors are multipliers; thus, a factor of 1.0 would mean no change.

**FIGURE 4-1
MONTHLY DISTRIBUTION OF Eto COMPARED TO BASELINE**



**FIGURE 4-2
MONTHLY DISTRIBUTION OF PRECIPITATION COMPARED TO BASELINE**

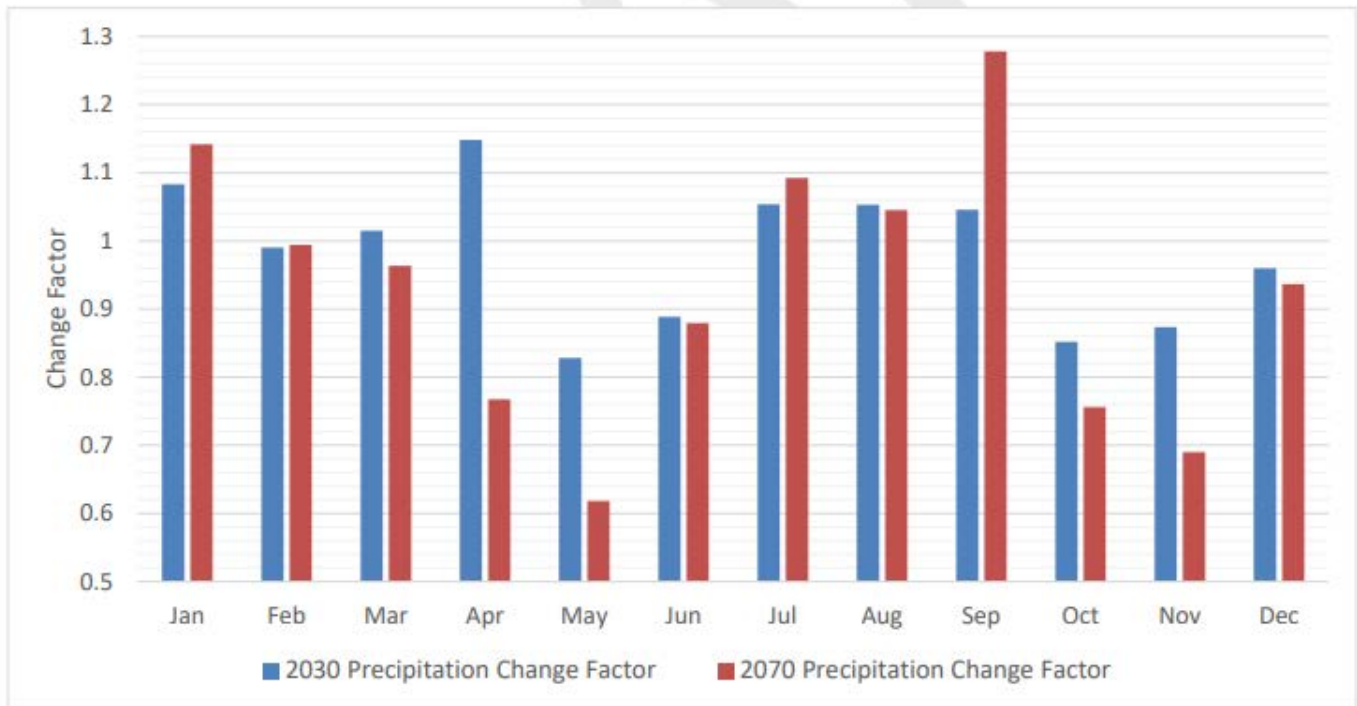

These climate change factors suggest that the monthly reference ETo in the Santa Clarita Valley is expected to be higher by approximately 5% in 2030, and 10% in 2070. Although by 2070, winter months would have experienced sharper warming than other months. With respect to precipitation, climate change is not expected to have much effect on the primary rainy months in the Santa Clarita Valley (December-March).

Overall, climate change is expected to have a more material impact on reference ETo than precipitation. To develop a climate change scenario that represents the land-use analysis' endpoint of 2050 the change factors for 2030 and 2070 were averaged since the midpoint of this period coincided with 2050.

This exercise yielded 12 monthly change factors each for reference ETo and precipitation. The econometric demand model was constructed at a monthly time step and used reference ETo and precipitation to model the impact of weather. These change factors were fed into the demand study's econometric model to forecast what demand would have been in demand study's base period of 2018 and 2019. The difference worked out to a projected increase of 3.77% on total production. This is lower than the increase in ETo as this increase is only applied to outdoor water use not to interior water use.

This climate change increase in demand is expected to arrive gradually over time, essentially starting with a 0% impact in 2020 rising to 3.77% in 2050. Between these two bracketing years (2020 and 2050) the impact of climate change is layered linearly on to the baseline demand forecast.

Both Groundwater and State Water Project water are impacted by climate change and these impacts are described below.

Groundwater

As described in Section 6 of the GSP, it incorporates several water balance analyses with three climate conditions, existing conditions, 2030 conditions, and 2070 conditions. These analyses incorporate the changes in ETo and precipitation that are identified above. Section 6 and Appendix I of the GSP documents how various components of water balance analyses interact with changes in ETo and precipitation. As demonstrated in the following diagram these interconnections are relatively complex.

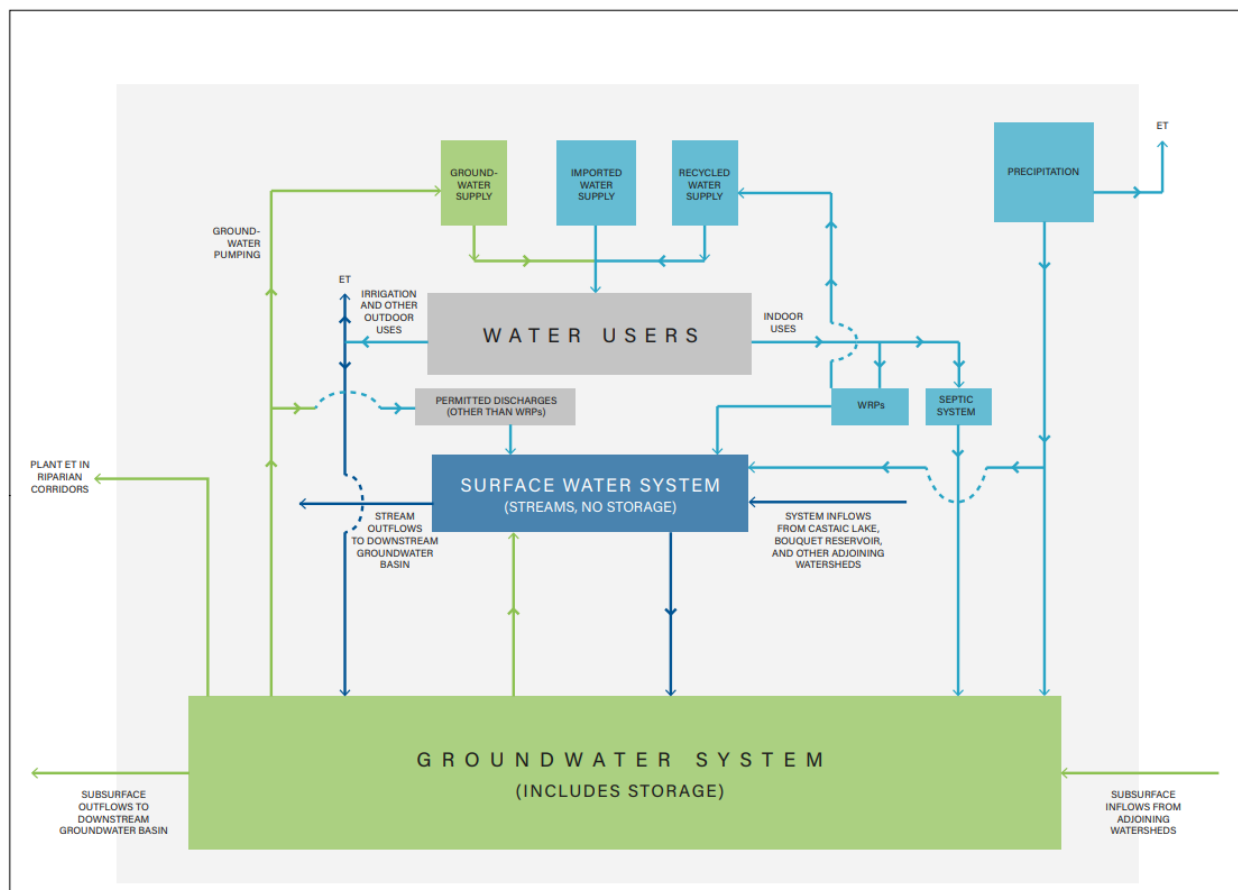

Changes in precipitation impact both surface and groundwater systems. Changes in ETo impact water needed by water users for irrigation as well as water used by Riparian Corridors. At the same time increases in imported supplies have the potential to increase flows to reclamation plants and discharges into surface water and the transfer of surface water to groundwater. The GSP utilized a numeric groundwater flow model (MODFLOW-USG) to account for these interactions and determine if the basin was being operated in a manner that resulted in the chronic lowering of groundwater levels or groundwater storage.

The projected water budgets, in Figures 6.1-9 through 6.1-11 in the GSP, show that the cumulative change curve for groundwater storage may shift slightly downward with climate change, the onset of slightly reduced precipitation and greater ET in the Basin. However, chronic declines in groundwater levels are not projected to occur over long periods, which indicates that SCV Water’s operating plan for the Basin is

unlikely to cause an overdraft condition in the local groundwater system (i.e., it is unlikely to exceed the basin yield) in the future under the assumed climatic conditions.

State Water Project Supplies

To determine water supplies available from the SWP, SCV Water relies on computer modeling performed by DWR and reported in the DCR. The 2019 DCR was the basis for SWP supplies reported in the 2020 UWMP. While the Draft 2021 DCR became available on December 31, 2021, it does not contain updated information on future SWP water supply availability. In absence of updated information use of the 2019 data continues to represent the most appropriate estimate future SWP availability.

To evaluate SWP supply availability under future conditions, the 2019 DCR included a model study representing hydrologic and sea level rise conditions in the year 2040. The future condition study used all of the same model assumptions as the study under existing conditions, but reflected changes expected to occur from climate change, specifically, projected temperature and precipitation changes centered around 2035 (2020 to 2049) under a higher emissions assumption and more conservative (45 cm) sea level rise. For the long-term planning purposes of this WSA and the 2020 UWMP, the long-term average allocations reported for the future conditions study from 2019 DCR is the most appropriate estimate of future SWP water supply availability.

The following text from the 2019 DCR Appendix B: Future Condition with Climate Change and 45 cm Sea Level Rise Scenario, provides a more thorough explanation on development of the 2040 modeling conditions.

The DCR 2019 Future Conditions scenario uses the same climate change hydrology inputs of the Incidental Take Permit (ITP) climate change studies. ITP climate change scenario was developed centered around 2035 (2020-2049). This is the best available climate change input hydrology to be used for DCR planning horizon (year 2040). DWR (2020) explains how the climate change projections conditions were developed:

“The climate projections were derived from the ensemble of 20 Coupled Model Intercomparison Project 5 (CMIP5) global climate projections selected by the California Department of Water Resources (DWR) Climate Change Technical Advisory Group (CCTAG) as the most appropriate projections for California water resources evaluation and planning (DWR CCTAG, 2015). The 20 climate projections, selected by CCTAG, were generated from 10 global climate models run with two emission scenarios, one optimistic (Representative Concentration Pathway [RCP] 4.5) and one pessimistic (RCP 8.5), identified by the Intergovernmental Panel on Climate Change (IPCC) for the Fifth Assessment Report (AR5) (2014).”

Two Sea Level Rise (SLR) projections were evaluated before establishing the final Future Conditions SLR. Below, we explain how the final Future Conditions SLR was selected between the 1 foot (ft) and 1.5 ft SLR projections. The Ocean Protection Council released the latest Sea-Level Rise Guidance in 2018 (OPC 2018). Table B-1 (OPC 2018) presents the three levels of risk aversion: low, medium-high, and extreme. The DCR 2019 scenarios included SLR projections in between: medium (1ft SLR) and near-high risk (45 centimeter or 1.5 ft SLR) which are summarized in Table B-2. The high emissions, 2040 row (Table B-1) was selected because of the 20-year “project lifespan” of DCR Future Conditions scenarios and due to the Incidental Take Permit’s March 31, 2040, expiration date. The 1.0 ft SLR has a 1-in-20 chance or 5%

exceedance probability while the 45 cm (1.476 ft) SLR has less than 0.5% exceedance probability (Table B-2).

Table B-1. Projected SLR (ft) for San Francisco (OPC 2018)

		Probabilistic Projections (in feet) (based on Kopp et al. 2014)			
		MEDIAN	LIKELY RANGE	1-IN-20 CHANCE	1-IN-200 CHANCE
		50% probability sea-level rise meets or exceeds...	66% probability sea-level rise is between...	5% probability sea-level rise meets or exceeds...	0.5% probability sea-level rise meets or exceeds...
				Low Risk Aversion	Medium - High Risk Aversion
High emissions	2030	0.4	0.3 - 0.5	0.6	0.8
	2040	0.6	0.5 - 0.8	1.0	1.3

Table B-2. DCR 2019 Preliminary Future Conditions (1 ft and 1.5 ft SLR projections for High Emissions, 2040)

Aversion projection (High emissions, 2040)	SLR (ft) projection
Low risk	0.8
Medium risk (DCR 19 1 ft SLR)	1.0
Medium-high risk	1.3
High risk (DCR 19 1.5 ft SLR)	1.476
Extreme risk	1.8

Between the 1 ft and 1.5 ft SLR, the 1.5 ft SLR Future Conditions scenario was chosen after feedback from management and some State Water Project Contractors.

The Appendix further provides annual water allocation for the period from 1922 through 2003. The model results in the 2019 DCR reflect a reduction in average SWP water supplies for 2020 conditions of 58% to future conditions average reliability of 52%. As discussed in Section 3.2.7 supply values between 2020 and 2040 are interpolated between these values and supplies beyond 2040 are assumed to be the same as 2040. Further the climate adjusted annual water allocation information for 2040 was used in SCV Water’s 2020 Updated Water Reliability Report.

4.9 Pending Water Use Efficiency

Recognizing the water supply challenges that California faces moving forward, in 2018, two policy bills were enacted by the California Legislature, Assembly Bill 1668 (AB1668, Friedman) and Senate Bill 606 (SB606, Hertzberg). Provisions of this legislation provide for the setting of long-term water efficient standards for 1) indoor residential use, 2) outdoor residential use, 3) outdoor irrigation used from dedicated irrigation meters and equivalent for large commercial, industrial, and institutional (CII-DIM) use, 4) water

loss, 5) certain variances and incentives for potable reuse. Further, water users will be required to establish urban water use objectives no later than January 1, 2024, incorporating these standards.

Regarding indoor residential water use, DWR is tasked in coordination with the SWRCB to conduct studies and prepare a report to the legislature with recommendations to potentially revise existing standards. This report, “Results of the Indoor Residential Water Use Study,” pursuant to Water Code Section 10609, has been submitted to the Legislature. It recommends the current standards be adjusted as indicated in the following Table 4-4.

**TABLE 4-4
RECOMMENDED INDOOR WATER USE STANDARDS**

Year	Current Standard (GCPD)	Recommended Standard (GCPD)
2020	55	55
2025	52.5	47
2030	50	42

As interior water use is the source of future recycled water, this has implications regarding availability of this water source. As previously discussed in Section 3, SCV Water intends to develop recycled water supplies from new development. As detailed in the Maddaus Water Demand Study, it was assumed interior water use of 50 gcpd. The recommended standard represents a 16% reduction in the availability of new recycled water supplies or from 8,511 to 7,149 AFY. When added to the existing 450 AFY this totals 7,599 AFY, a potential reduction of 912 AFY or about 1% of total water demand.

On the other hand, provisions of the legislation concerning irrigation water use efficiency will likely offset this potential reduction in supply. Under the legislation, DWR is to conduct studies and make recommendations to the SWRCB regarding outdoor water use and variances and incentives and the SWRCB shall adopt standards by June 30, 2022. The legislation specifically calls for outdoor water use standards to incorporate the principles of the MWELo (Model Water Efficient Landscape Ordinance). This will have implications for both existing and future water users.

Regarding future water users, the 2020 UWMP based future outdoor water use on MWELo plus an overwatering factor. As noted in Appendix F of the 2020 UWMP, exterior water demands for future development are based on 2015 MWELo plus 25.6% overwatering factor. This increase in exterior water use was based on a technical study that compared actual irrigation demand from properties developed after 2015 MWELo took effect. (2020 UWMP Appendix F – Population and Demand Technical Memorandum, Maddaus, April 2021 Appendix F – (Residential and Non-Residential outdoor Water Use Study pg. 11). Overall water demand attributed to new users is approximately 30 TAF and 60% of which is for outdoor water. Thus, assuming SCV Water adopts measures and or regulations that require future customers to meet MWELo requirements, water demands would be reduced by approximately 3,800 AFY. This more than offsets the reduction in supply of 1,362 AFY.

Determining the application of the MWELo principles relating to existing customers outdoor water use will be more complex. This involves producing credible data to determine landscape area while accounting for the age of existing installations and its inherent limits of design efficiency, along with a number of other factors. A draft report has been released to the stakeholders for comments but at this time DWR has not

produced its report on outdoor water efficiency standards. SCV Staff following this process anticipate application of expected standards will likely require further reductions in outdoor water use.

Thus, while changes in efficient water use requirements may result in the shifting of the resource mix used to achieve water reliability standards, it does not appear that such changes would result in a less reliable water supply portfolio. Refinement of water use efficiency standards and the implied reductions in demand will be forth coming, however, until a more thorough analysis can be conducted, it is reasonable and likely conservative to use the assumptions in the 2020 UWMP for conservation and recycled water.

4.10 Water Supply Reliability Modeling

SCV Water's strategy for achieving water supply reliability has involved the development of a diverse water supply portfolio that can accommodate the variability of wet and dry periods endemic to California's climate. The variability in SWP supplies has the largest effect on overall supply reliability. In any given year, SWP supplies may be reduced due to dry weather conditions or regulatory factors. During such an occurrence, the remaining water demands in the SCV Water service area would be met by SCV Water's diverse alternate water supplies. The alternate supplies that would make up for any reductions in SWP supplies include a combination of supplies, such as return water from SCV Water's water storage accounts in the Semitropic Groundwater Storage Bank and the Rosedale-Rio Bravo Water Banking and Exchange Program, deliveries from SCV Water's flexible storage account in Castaic Lake Reservoir, local groundwater pumping from the Saugus Formation, short-term water exchanges, and participation in DWR's dry-year water purchase programs, among other sources. The diversity of such alternative supplies adds to the reliability because factors that may impact one supply source, such as drought, may not directly impact other sources, such as banked water.

The available water supplies and demands for SCV Water's service area were analyzed in the 2020 UWMP to assess the region's ability to satisfy demands during the following variable periods: (1) an average water year; (2) a single-dry year; and (3) multiple-dry years. The 2020 UWMP summary tables demonstrate that existing and planned supplies are available and sufficient to meet existing and projected demand under all such conditions for the projected planning period through 2050. The analysis also accounts for the water needed to serve the Project because SCV Water included the Project demand in SCV Water's current and projected water deliveries data provided as part of the adopted 2020 UWMP. Furthermore, the 2020 UWMP concludes that SCV Water's current and proposed groundwater supplies from the Alluvial Aquifer and the Saugus Formation are sustainable, and that current and future pumping levels, when combined with non-purveyor pumping, for average year, single-dry year, and multiple-dry years, remain within the basin yield.¹²

In addition to the above-mentioned UWMP reliability assessment, SCV Water periodically updates its Water Supply Reliability Plan (Plan) to identify current and future storage capacity and emergency storage needs and options for managing its water supplies. The 2019 Water Supply Reliability Plan Update (Geosyntec 2021) is the most current Plan.

This Plan evaluates six supply scenarios driven by varying assumptions regarding projected local supply availability and reliability, with each supply scenario evaluated against two demand sets (projected demands with and without active conservation).

The Plan uses an analytic spreadsheet model developed for SCV Water by MBK Engineers and updated by Geosyntec Consultants in 2021 to assess the reliability of SCV Water's water supplies. The model

¹² 2020 UWMP, p. 7-2.

performs annual water operations for the SCV Water service area over a specified study period (2021 through 2060), using projected increases in demands to reflect the uncertainty in the hydrology over this period, using supplies that would be available under multiple hydrologic sequences. For each hydrologic sequence, the model steps through each year of the study period, comparing annual supplies to demands and operating SCV Water storage programs as needed, adding to storage in years when supplies exceed demand, and withdrawing from storage when demand exceeds supplies. Results from the multiple hydrologic sequences are then compiled and summarized to provide a statistical assessment of the reliability of SCV Water's supplies and storage programs to meet its projected demands over the study period.

In addition to the hydrologic reliability of the Santa Clarita Valley's overall water supply, the Plan also discusses the physical reliability of the water delivery system in place to deliver its groundwater, imported water, and recycled water supplies. Deliveries of these supplies are dependent on an extensive network of SWP facilities used to pump, store, and convey SWP and other imported supplies, and SCV Water and purveyor facilities to treat, pump, and distribute supplies. Supply delivery can be interrupted or constrained in a number of ways, and the Plan includes an assessment of the ability to meet demands during an extended 12-month outage.

For this Plan update, the study period analyzed is 2021 through 2060 (which is 10 years after the assumed development buildout in the SCV Water's service area assumed in the 2020 Urban Water Management Plan (UWMP)). The analysis starts with a Base Scenario and evaluates five additional scenarios, with and without active conservation. This analysis builds on information contained in the 2019 DWR DCR as it incorporates 2040 climate change conditions discussed above in this Section and uses the same hydrologic sequence from the CALSIM 2 model. A further description of the model and the scenarios are contained in Section 7.45 of the 2020 UWMP and the 2019 Plan.

The reliability analysis conducted in the Plan is more rigorous and conservative than that contained in the 2020 UWMP and in Section 5.1. The Plan models the operation of SCV Water's supply portfolio through the full 82-year historical hydrologic period and incorporates projected storage balances when determining the quantity of water available from a banking program to meet water demands during dry periods. Further, while UWMP Section 5.2 incorporated a gradual decline in SWP reliability between 2020 and 2040 due to climate change, the Plan's modeling is based on SWP hydrology adjusted to reflect 2040 climate change, being applied to all years in the study period.

These scenarios represent 12 different views of future supply situations. Each supply scenario is evaluated in the Plan to determine the reliability of that scenario in meeting projected demands in SCV Water's service area. The reliability for all future scenarios (1 through 5) is greater than 95 percent.

The Plan analyzed various scenarios, which analyses can be used to answer several questions including:

1. How long current facilities could be relied upon to achieve reliability?
2. If the mix of existing and proposed facilities in the UWMP achieved reliability through 2050?
3. If certain future facilities were not constructed, (specifically some or all of the new Saugus Formation wells were either not constructed or otherwise unavailable) would alternative programs that SCV Water is investigating be able to achieve reliability?
- 4.

A summary of the scenarios studied are shown in Table 4-5.

**TABLE 4-5
VARIOUS SCV WATER SUPPLY SCENARIOS**

	Base	1	2	3	4	5
Alluvial Pumping	✓	✓	✓	✓	✓	✓
Existing Saugus	✓	✓	✓	✓	✓	✓
SWP and BVRRB	✓	✓	✓	✓	✓	✓
Existing Banking Programs	✓	✓	✓	✓	✓	✓
Saugus Wells 3 and 4		✓	✓	✓		
Saugus Wells 5 - 8		✓				
New Rosedale Bank Capacity		✓	✓	✓	✓	
Sites Reservoir				✓	✓	✓
AVEK High Desert Bank			✓		✓	✓
McMullin GSA Aquaterra Bank						✓

The Base represents those elements of the SCV Water’s portfolio that currently exist. This includes existing and restored groundwater supplies. As the analysis moves through the study period restoration of well capacity temporarily taken out for water quality concerns takes place consistent with Table 4-6B, Table 4-6C, Table 4-8B, and Table 4-8C in the 2020 UWMP. Imported supplies include SWP supplies based on 2040 climate conditions pursuant to DWR’s CALSIM modeling for the 2019 Delivery Capability Report, the firm Buena Vista Rosedale Transfer, and if necessary, in dry years, SWP Flexible Storage, Nickel Water (after 2035), Yuba Accord water. The Base case also includes the existing banking programs, specifically existing Rosedale Banking supplies at the existing 10,000 AFY of recovery, SCV Water Semitropic and access to the Newhall Land and Farming withdrawal capacity (after 2035), that are drawn on during years when the other previously mentioned supplies are insufficient to meet demands.

Scenario 1 adds Saugus Formation wells 3-8 and 10,000 AFY of additional extraction capacity from the Rosedale Banking Program as provided for in the 2020 UWMP.

Scenarios 2-5 were designed to analyze if in the event of the removal of some or all future Saugus Formation Wells (and in one case the expansion of the Rosedale Bank) could reliability be achieved through other programs that SCV Water is considering participating in, specifically Sites Reservoir, AVEK’s High Desert Bank and the McMullin’s Aquaterra Water Bank.

Figure 4-3 summarizes the modeling results.

**FIGURE 4-3
FINAL RELIABILITY RESULTS WITH ACTIVE CONSERVATION**

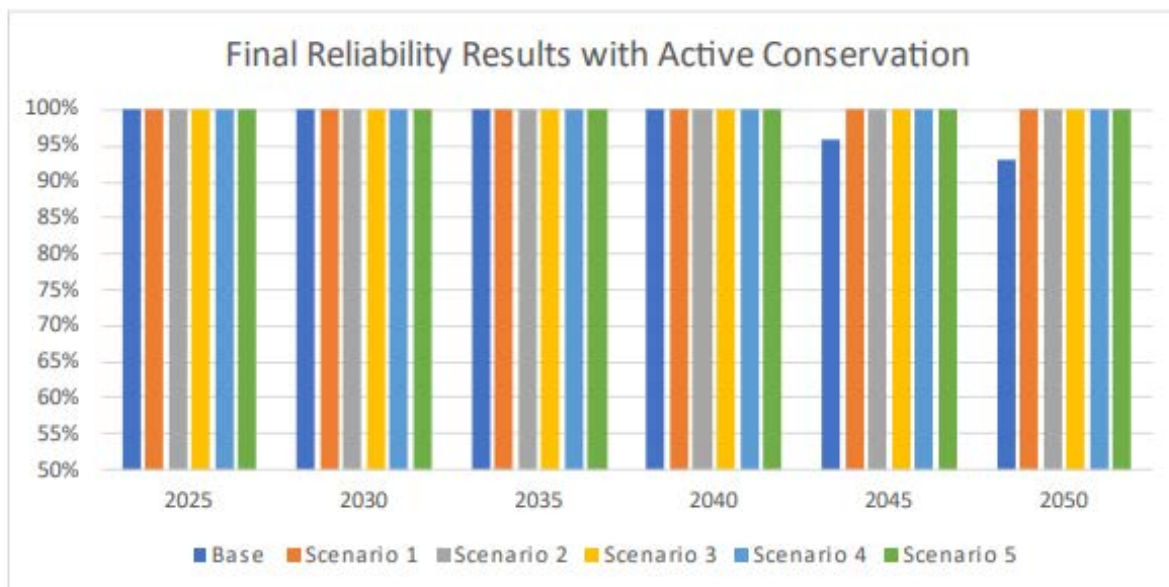

With respect to the first question above, the analysis shows that current supplies (including recovered groundwater capacity) along with active conservation will be sufficient through at least 2040.

Regarding the second question, to achieve reliability in subsequent years, additional investments in those programs and facilities identified in the UWMP (Scenarios 1) would be sufficient to achieve reliability through 2050.

As to the third question, Scenarios 2-5 demonstrate that alternative programs to those contained in the UWMP could offer different paths to achieve reliability or if implemented in addition to the UWMP could provide additional supplies in excess of demand.

Conclusions

As discussed above, the analysis contained in the Plan represents a more robust and conservative analysis than that contained in the 2020 UWMP. Nevertheless, the conclusions related to the ability of SCV Water to reliably meet water demands are consistent. If SCV Water continues to implement active water conservation measures, conjunctively use its imported water, groundwater, and water banking facilities, and invests in future water supply facilities as identified in the 2020 UWMP it will reliably meet water demands in its service area through 2050. The ability to implement other alternative water supply programs identified in the Plan’s analysis bolsters this conclusion as alternatives exist should some of the future water supplies identified in the 2020 UWMP become unattainable.

4.11 Water Conservation and Water Shortage Contingency Planning

Water supplies may be interrupted or reduced due to a number of factors, such as a drought which limits supplies, an earthquake which damages water delivery or storage facilities, a regional power outage, or a toxic spill that affects water quality. The 2020 UWMP describes in detail how SCV Water is responding to such water supply outages, reductions, and other emergencies so that customer needs are met

adequately, promptly, and equitably. With the completion of the 2020 UWMP, SCV Water also completed a comprehensive Water Shortage Contingency Plan that outlines the states of action SCV Water will take depending on the severity of a particular shortage for each supply source available to SCV Water. In addition, prohibitions, penalties, and financial impacts of shortages have been developed by SCV Water and are summarized in both the 2020 UWMP and 2020 Water Shortage Contingency Plan.

In preparing this WSA, SCV Water considered the urban water shortage contingency planning analysis set forth in the 2020 UWMP and 2020 Water Shortage Contingency Plan in determining the sufficiency of water supplies for the proposed Project, in addition to all existing and planned future uses in SCV Water's service area within the Santa Clarita Valley. These documents also explain how SCV Water's reliability planning provisions of these adopted documents assist SCV Water in responding to drought conditions, including the severe drought conditions that currently exist.

Section 5: Water Supply Assessment

Consistent with the provisions of SB 610, neither this WSA nor its approval shall be construed to create a right or entitlement to water service or any specific level of water service, and shall not impose, expand, or limit any duty concerning the obligation of SCV Water to provide certain service to its existing customers or to any future potential customers.

The WSA does not constitute a will-serve, plan of service, or agreement to provide water service to the Project, and does not entitle the Project, Project Applicant, or any other person or entity to any right, priority or allocation in any supply, capacity, or facility. To receive water service, the Project will be subject to an agreement with SCV Water, together with any and all applicable fees, charges, plans and specifications, conditions, and any and all other applicable SCV Water requirements in place and as amended from time to time. Nor does anything in this WSA prevent or otherwise interfere with SCV Water's discretionary authority to declare a water shortage emergency in accordance with the Water Code.

SCV Water is implementing plans that include projects and programs to help ensure that the existing and planned water users within the Santa Clarita Valley have an adequate supply.

The analyses presented in the following tables verify the availability of water supply for the Shadowbox Studios Development Project, in addition to all existing and planned future uses in the SCV Water service area over a 30-year horizon (exceeding the requirements of SB 610's 20-year planning horizon) in average/normal years, a single dry-year, and in multiple-dry years.

Furthermore, while not required by SB 610, as a conservative measure, this WSA demonstrates that sufficient water supplies will be available to meet the projected water demands associated with the proposed Project during normal, single-dry, and multiple-dry years over a 30-year horizon, in addition to existing and planned future uses (including agricultural, manufacturing, and industrial uses) throughout the entire Santa Clarita Valley.

5.1 Water System Operations and Reliability Planning

As discussed herein, SCV Water has implemented a number of projects that are part of an overall program to provide the facilities needed to ensure reliable imported and local water supplies during dry years. The program involves water conservation, surface and groundwater storage, water transfers and exchanges, water recycling, additional short-term pumping from the Saugus Formation, and increasing SCV Water's imported supply. This overall strategy is designed to meet increasing water demands while assuring a reasonable degree of supply reliability. Part of the overall water supply strategy is to provide a blend of groundwater and imported water to area residents to ensure consistent quality and reliability of service. The actual blend of imported water and groundwater in any given year and location in the Santa Clarita Valley is an operational decision and varies over time due to source availability and operational capacity SCV Water's facilities. The goal is to conjunctively use available water resources so that the overall reliability of water supply is maximized while utilizing local groundwater at a sustainable rate.

The available water supplies and demands for SCV Water's service area were analyzed in the 2020 UWMP to assess the region's ability to satisfy demands during the following variable periods: (1) an average water year; (2) single-dry year; and (3) multiple-dry years, which included an assessment of a five-year dry period. The supply and demand comparison tables 5-2,5-3 and 5-4 (shown in Sections 5.1.1 to 5.1.4 below)

5-1

utilize demonstrate that existing and planned supplies are available to meet existing and projected demand under all such conditions for the projected planning period through 2050. These tables are consistent with the 7-2, 7-3 and 7-4 in the UWMP with the exception that Table 5.2 reflects updated SWP Table A Amounts consistent with the DWR's 2021 Draft DCR and Planned Future and Recovered Groundwater supplies reflect the adjusted planning, construction and planning schedules as discussed in Section 3.3.2.3 Available Groundwater Supplies.

While many of the Santa Clarita Valley's available supply sources have some variability, the variability in SWP supplies has the largest effect on overall supply reliability. In any given year, SWP supplies may be reduced due to dry weather conditions, regulatory restrictions, or other factors. As discussed above, during such an occurrence, the remaining water demands in the SCV Water's service area are planned to be met by a combination of alternate supplies such as return water from SCV Water's accounts in the Semitropic Groundwater Storage Program and the Rosedale–Rio Bravo Water Banking and Exchange Program, deliveries from SCV Water's flexible storage account in Castaic Lake Reservoir, local groundwater pumping, short-term water exchanges, and participation in DWR's dry-year water purchase programs.

As stated in the 2020 UWMP, water supply reliability for SCV Water has improved significantly with the development of conjunctive use and groundwater banking. Conjunctive use is the coordinated operation of multiple water supplies to achieve improved supply reliability. During dry periods, or when imported water supply availability is reduced, banked water can be recovered from groundwater storage to replace, or firm up, the imported water supply deliveries. SCV Water has been conjunctively utilizing local groundwater and imported water since SWP water was imported to the Santa Clarita Valley beginning in 1980. SWP and other imported water supplies have supplemented the overall supply of the Santa Clarita Valley, which previously depended solely on local groundwater supplies.

Drought periods may affect available water supplies in any single year and even for a duration that spans multiple consecutive years. Hydrologic conditions vary from region to region throughout the state. Dry conditions in northern California affecting SWP supply may not affect local groundwater and other supplies in southern California, and the reverse situation can also occur (as it did in 2002 and 2003). For this reason, SCV Water has emphasized developing a water supply portfolio that is diverse, especially in dry years. Diversity of supply is considered a key element of reliability planning, giving SCV Water the ability to draw on multiple sources of supply to ensure reliable service during dry years, as well as during average wet years.¹³

Provided below is a summary of historical water supplies used by SCV Water along with updated water supply projections presented in the 2020 UWMP that also address certain information required under SB 610 for the proposed Shadowbox Studios Development Project.

¹³ 2020 Santa Clarita Valley Water Report (June 2021).

**TABLE 5-1
SCV WATER HISTORICAL SOURCES OF SUPPLY (AFY)**

SOURCE	2011	2012	2013	2014	2015	2016	2017	2018	2019	2020	2021 prelim
Alluvial	26,186	25,593	21,431	24,683	19,333	15,244	9,424	14,030	9,049	7,571	14067
Saugus	7,438	8,133	8,348	9,929	10,560	11,085	6,979	8,839	8,498	9,761	11478
TOTAL GROUNDWATER	33,624	33,726	29,779	34,612	29,893	26,329	16,403	22,869	17,547	17,332	25,545
Recycled Water	373	428	400	474	450	507	501	352	458	468	480
SWP %	80%	65%	35%	5%	20%	60%	85%	35%	75%	20%	5%
SWP Deliveries to SCV Water Service Area ^(a)	20,445	36,153	33,126	13,097	15,196	31,888	47,912	36,835	41,111	14,871	10,934
Table A	10,713	24,657	4,692	451	11,075	29,647	32,422	12,411	37,503	11,551	1,081
Carryover	9,332	11,496	28,434	7,743	4,121	2,241	15,490	24,424	3,608	3,036	6,523
Article 21	400	0	0	0	0	0	0	0	0	0	
Turnback Pool Water	0	0	0	0	0	0	0	0	0	0	
Yuba	0	0	0	445	0	0	0	0	0	284	1,170
Other DWR coordinated transfers	0	0	0	34	0	0	0	0	0	0	194
Flex Storage Withdrawals	0	0	0	4,424	0	0	0	0	0	0	1,966
SWP Deliveries to Out of Service Area Storage/Exchange ^(b)	21,608	10,000	0	0	4,339	1,500	5,425		24,502	0	5,628
RRBWS D Banking	1,006	6,031	0	0	0	0	0	0	0	0	
Semitropic WSD Banking	0	0	0	0	0	0	5,340	0	5,002	0	
Rosedale Exchange Program	15,602	3,969	0	0	0	0	0	0	11,000	0	
WKWD Exchange Program	5,000	0	0	0	0	0	0	0	0	0	
CCWA Exchange Program	0	0	0	0	0	1,500	0	0	0	0	
AVEK Exchange Program	0	0	0	0	0	0	0	0	7,500	0	
UWCD Exchange Program	0	0	0	0	0	0	0	0	1,000	0	
Flex Storage Refill	0	0	0	0	4,339		85	0	0	0	1,966
Back up San Luis Storage	0	0	0	0	0	0	0	0	0	0	3,662
Withdrawals from Out-of-Service Area Storage/Exchange ^(b)	0	0	0	9,774	2,998	0	0	0	750	22,957	21,323
RRBWS D Banking	0	0	0	2,824	2,998	0	0	0	0	1,600	16,323
Semitropic WSD Banking	0	0	0	0	0	0	0	0	0	5,000	5,000
Rosedale Exchange Program	0	0	0	0	0	0	0	0	0	14,451	

WKWD Exchange Program	0	0	0	2,000	0	0	0	0	0	500	
CCWD Exchange Program	0	0	0	0	0	0	0	0	750	0	
NLF Semitropic Banking	0	0	0	4,950	0	0	0	0	0	0	
AVEK Exchange Program	0	0	0	0	0	0	0	0	0	1,406	
UWCD Exchange Program	0	0	0	0	0	0	0	0	0	0	
Other Imported Deliveries to SCV Water Service Area ^{(c)(d)}	11,000	0	0	11,000	10,995	0	0	0	0	11000	9,685
Other Imported Deliveries to Out-of-Service Area Storage/Exchange ^(d) or Water Sale	2,188	19,569	28,629	0	0	11,000	11,370	5,062	10,282	0	1,315
Total Imported Supplies to SCV Water Service Area	31,445	36,153	33,126	33,871	29,189	31,888	47,912	42,835	42,961	48,828	41,942
Total Local and Imported Supplies Utilized in SCV Water Service Area	65,442	70,307	63,305	68,957	59,532	58,724	64,816	66,056	60,966	66,628	67,967
End of the year carryover supply (left over table A and carryover noted in text)	41,651	48,809	21,482	18,048	21,899	51,571	42,788	39,211	9,013	13,466	13,633

Sources: DWR Bulletin 132, Management of the California State Water Project; and DWR delivery files.

Notes:

- (a) Includes deliveries of Table A supplies, carryover water, Article 21 water, Turnback Pool water, local supply (from West Branch reservoirs), Yuba Accord water and water purchased through DWR.
- (b) Out-of-service area storage includes flexible storage refill in Castaic Lake, the SCV Water Semitropic Banking Program, NLF Semitropic Banking Program and the Rosedale-Rio Bravo Banking Program. Exchanges include programs with the Rosedale-Rio Bravo, West Kern Water District, Central Coast Water Agency, Antelope Valley East Kern, and United Water Conservation District.
- (c) Deliveries from Buena Vista.
- (d) Includes BVRRB water sales and deliveries to Devils Den service area. Also includes BVRRB deliveries to banking programs and exchanges, or San Luis backup storage.

5.1.1 Historical Operations of Santa Clarita Valley Water System

A review of the period from 2011 through 2021 is provided in Table 5.1. This table illustrates the previous discussion in this section. Add text with specific examples to support previous points in Section 5.1.

2011 was characterized as a wet year resulting in a high SWP Table A allocation of 80%. With wet conditions and surplus Table A water, SCV Water executed two 2:1 exchange programs totaling 20,602 AF and delivered 1,006 AF of water to be stored in the RRBWSD banking program in order to utilize as

much water as possible for future years. Excess Table A and carryover supplies not utilized totaled 41,651 AF to be available as carryover in 2012.

2012 was characterized by an increase in water use attributed to unseasonably high temperatures and below normal rainfall in early 2012 resulting in a longer irrigation season. The water year ended up with average precipitation which resulted in a SWP Table A allocation of 65%. SCV Water started the year with 41,651 AF of Article 56 Carryover supply, of which 30,155 AF was reclassified due to reservoir levels filling up. With surplus water, SCV Water sold 16,500 AF of BVERRB water (annual supply plus banked supply) to West Kern County Agriculture Water Districts, banked 6,301 AF into RRBWSD banking program and further exchanged 3,969 AF in the RRBWSD 2:1 exchange program. SCV Water used 11,496 AF of carryover and ended the year with 2013 carryover supplies totaling 48,809 AF.

2013 was characterized with unseasonably high temperatures and below normal rainfall resulting in a lower SWP Table A allocation of 35%. The SCV Water service area grew rapidly in 2013 with 5% increased demands and 750 new service connections added. Imported carryover and Table A water were utilized to meet imported demands. 28,000 AF of supplies were sold to other agencies to bring in revenue and reduce loss of excess supplies. Even with previous years carryover water being reclassified due to wet hydrology, SCV Water was able to reserve 21,482 AF unused Table A into carryover for the start of 2014 in preparation of continued or worsening drought conditions.

2014 was characterized by extremely dry conditions locally and statewide resulting in a historically low SWP Table A allocation of 5%. To meet dry year imported demands SCV Water utilized 7,743 AF of carryover supplies, recovered 9,774 AF from banking and exchange programs, withdrew 4,424 AF from Castaic Flexible Storage, and received 445 AF from Yuba County Accord Water. In addition, state mandated conservation program regulations helped drive water demands down reserving 18,048 AF of unused carryover and Table A supplies for 2015 if drought conditions persisted.

2015 was characterized by a fourth year of drought with record high temperatures, record low precipitation and record low snowpack. 2015 was recorded as one of the driest and warmest winters since 1950 resulting in a SWP Table A allocation of 20%. In 2015 SCV Water entered into an agreement with Semitropic to participate in the Stored Water Recovery Unit (SWRU) as an additional source of dry-year water supply. SCV Water utilized Table A supply, carryover supply, BVERRB supply and recovered 2,998 AF from the RRB water banking program to meet imported demands. 4,339 AF of unused Table A supply were backfilled to the flexible storage account utilized in 2014. 2015 total unused carryover and Table A supplies available for 2016 totaled 21,892 AF.

2016 was characterized by average precipitation in northern California, an improvement to the previous four years of drought with enough precipitation to offset some of the large deficits in water storage reservoirs resulting in a SWP Table A allocation of 60%. SCV Water saw demands increase in 2016 from the easing of SWRCB emergency water conservation measures shifting from mandatory to voluntary. Imported demands were met with minimal carryover and Table A supplies. SCV Water exchanged 1,500 AF of Table A water and stored 5060 AF of BVERRB water into the Rosedale banking program. The remaining BVERRB supply was stored in San Luis reservoir and added to 2017 carryover supplies which totaled 51,571 AF at the end of the year.

2017 was characterized by the second largest statewide runoff and the end of the state's 5-year drought. 2017 snow water equivalent came in at 163% of April 1st average resulting in a large SWP Table A allocation of 85%. Of the 51,571 AF of carryover storage available in 2017, 15,490 AF was delivered to SCV Water service area and the rest was reclassified due to the wet hydrology. With surplus Table A SCV Water backfilled the remaining 85 AF to the Castaic flexible storage account and maximized deliveries to

banking programs totaling 5,340 AF (storage space only available in Semitropic SWRU, RRBWSD program full). With plenty of Table A and carryover supplies, SCV Water sold BVRRB water supply to Kern County Westside Districts. Remaining Table A supplies totaled 42,788 in carryover for 2018.

2018 was characterized by dry conditions returning statewide with nearly all the state experiencing below-average precipitation and SCV Water receiving less than half its average annual precipitation. This resulted in a lower than average SWP Table A allocation of 35%. Imported demands were met with carryover and Table A supplies, with the remaining supplies being carried over into 2019 totaling 39,211 AF.

2019 was characterized by above average precipitation locally and statewide resulting in somewhat lower demands and an above average SWP Table A allocation of 75%. SCV Water started the year with 39,221 AF of Article 56 Carryover supply which 3,608 AF was delivered, and the remaining 35,603 AF was lost as a result of wet hydrology. The high allocation allowed for SCV Water to reduce local pumping of groundwater to maintain sustainable groundwater resources in dry-year and increase imported Table A deliveries to the service area. In addition, SCV Water executed three different 2:1 water exchanges with other State Water Contractors totaling 19,500 AF and delivered 5,000 AF to Semitropic SWRU banking reserves. Remaining unused Table A water was categorized as 2020 carryover supply totaling 9,013 AF.

2020 was characterized by below average precipitation locally and statewide resulting in higher water demands and a low SWP Table A allocation of 20%. SCV Water also faced an increased demand for imported water supplies due to significant loss of local groundwater wells impacted by updated regulations related to PFAS (Per and Polyfluoroalkyl Substances). Increased imported demands were met utilizing banking, exchanges, and transfer programs. The completion of the Drought Replacement Wells in 2019 at the Rosedale-Rio Bravo Water Banking Program (RRBWBP) increased recovery capacity from 3,000 AFY in 2014 and SCV Water was able to recover 16,501 AF from the RRB Banking and Exchange programs. An additional 5,000 AF was recovered from the Semitropic SWRU and 1,906 AF from exchange programs. SCV Water utilized 3,036 AF of 2020 carryover supplies, conserving unused carryover and Table A supplies for 2021 carryover which totaled 13,466 AF.

2021 was characterized as an extreme water year in terms of precipitation and temperature and ended up as California's second driest year on record based on statewide runoff resulting in a second lowest SWP Table A allocation of 5%. Santa Clarita experienced its driest water year on record, only receiving 3.38 inches of precipitation all year. SCV Water continued to be impacted by loss of local groundwater wells related to PFAS, but successfully completed combined treatment facilities for three major alluvial wells which came online in 2021 adding critically needed water to local supplies to meet demands. In addition to maximizing groundwater production, SCV Water recovered about 25,000 AF of water from imported banking programs, 1,364 AF from dry year transfer programs, and utilized 1,966 AF from the Castaic flexible storage account to meet imported demands. In preparation of continued drought conditions, only 6,523 AF of carryover supplies were used, the Castaic flexible storage account was refilled, and excess banking, transfer water and Table A supplies not needed to meet demands were reserved as carryover for 2022, totaling 13,633 AF.

5.1.2 Average/Normal Year Supplies and Demand Comparison

Table 5-2 summarizes the supplies available to meet demands over the 30-year planning period during an average/normal year. As presented in the table, the water supply is broken down into existing and planned water supply sources, including wholesale (imported) water, local supplies, and banking programs. The demands shown include reductions from projected passive conservation savings, and both with and without active conservation savings. Future demands include that of the Shadowbox Studios Development Project.

	2025	2030	2035	2040	2045	2050
Existing Supplies						
Existing Groundwater ^(a)						
Alluvial Aquifer ^(c)	8,900	8,180	7,300	7,300	7,300	7,300
Saugus Formation ^(c)	12,940	7,110	7,110	7,110	7,110	7,110
Total Groundwater	21,840	15,290	14,410	14,410	14,410	14,410
Recycled Water ^(b)						
Total Recycled	450	450	450	450	450	450
Imported Water						
State Water Project ^(c)	52,360	51,410	50,460	49,500	49,500	49,500
Flexible Storage Accounts ^(d)						
Buena Vista-Rosedale	11,000	11,000	11,000	11,000	11,000	11,000
Nickel Water - Newhall Land ^(e)	-	-	1,607	1,607	1,607	1,607
Yuba Accord Water ^(f)	1,000	-	-	-	-	-
Total Imported	64,360	62,410	63,067	62,107	62,107	62,107
Existing Banking and Exchange Programs ^(g)						
Rosedale Rio-Bravo Bank ^(g)	-	-	-	-	-	-
Semitropic Bank ^(g)	-	-	-	-	-	-
Semitropic – Newhall Land Bank ^(g)	-	-	-	-	-	-
Antelope Valley West Kern Water Agency Exchange ^(g)	-	-	-	-	-	-
United Water Conservation District Exchange ^(g)	-	-	-	-	-	-
Total Bank/Exchange	0	0	0	0	0	0
Total Existing Supplies	86,650	78,150	77,927	76,967	76,967	76,967
Planned Supplies						
Future and Recovered Groundwater ^(h)						
Alluvial Aquifer ^{(i)(c)}	9,845	19,870	23,490	23,490	23,490	23,490
Saugus Formation ^{(i)(c)}	3,000	2,790	2,790	2,790	2,790	2,790
Total Groundwater	12,845	22,660	26,280	26,280	26,280	26,280
Recycled Water ^(k)						
Total Recycled	1,849	3,696	5,091	6,498	7,499	8,511
Planned Banking Programs						
Rosedale Rio-Bravo Bank ^{(h)(l)}	-	-	-	-	-	-
Total Banking	0	0	0	0	0	0
Total Planned Supplies	14,694	26,356	31,371	32,778	33,779	34,791
Total Supplies (Existing and Planned)^(m)	101,344	104,506	109,298	109,745	110,746	111,758
Demands⁽ⁿ⁾						
Demands with passive conservation ⁽ⁿ⁾	82,100	89,300	97,600	104,300	109,600	115,100
Demands with passive and active conservation ⁽ⁿ⁾	76,400	81,700	88,700	93,600	97,500	101,000

5-7

Notes:

- (a) Existing groundwater supplies represent the quantity of groundwater available to be pumped with existing wells. Declines from 2025 pumping levels reflect transfer of normal year pumping from existing wells to future and recovered wells.
- (b) Existing Recycled Water is based on current average annual use.
- (c) SWP supplies are based on average deliveries from DWR's 2019 DCR and 2021 draft DCR (56% - 52% at buildout due to climate change).
- (d) Supplies not needed in average years.
- (e) Existing Newhall Land supply committed under approved Newhall Ranch Specific Plan. Water is available from 2021 -2034 to meet supply shortfalls associated with the Newhall Ranch Specific Plan. Assumed to be transferred to SCV Water once Newhall Ranch development is completed around 2035.
- (f) Supply available for purchase every year, however, shown is amount available in dry periods, after delivery losses. This supply would typically be used only during dry years and is available through 2025.
- (g) Supplies not needed in average years.
- (h) Future and Recovered groundwater supplies include recovered impacted wells and new groundwater well capacity that may be required by SCV Water's production objectives in the Alluvial Aquifer and the Saugus Formation. When combined with existing Agency and non-Agency groundwater supplies, total groundwater production remains within the sustainable ranges identified in Tables 4-10 and 4-11 and is within the groundwater basin yields per the 2020 SCV-GSA Water Budget Development Tech Memo (GSI 2020) and the updated Basin Yield Analysis (LSC & GSI 2009).
- (i) Future Category includes all wells restored from PFAS and Perchlorate water quality issues, and other future alluvial wells including those associated with development under the Newhall Ranch Specific Plan. Schedule for recovered well capacity based on Groundwater Treatment Implementation Plan Technical Memorandum, Kennedy Jenks 2021 Appendix M. 2025 adjustments based on January 2022 engineering project schedule updates.
- (j) Future and Recovered Saugus wells include perchlorate-impacted Well 205, two replacement wells (Saugus 3 & 4), and up to four new wells (Saugus 5-8) planned to provide additional dry-year supply. New dry-year wells would not typically be operated during average/normal years.
- (k) Planned recycled water is the total projected recycled water use from Table 5-3 less existing use. Projections reflect demands that can be cost-effectively served with projected supplies. Refer to Section 5 for additional details on recycled water demands and supplies.
- (l) Firm withdrawal capacity under existing Rosedale Rio-Bravo Banking Program to be expanded by 10,000 AFY by 2030 (for a combined total of 20,000 AFY).
- (m) For completeness, LAWWD36 sales are included in demands and supplies. Breakdown of LACWWD 36 and SCV Water Demands are shown in Table 2-10. Further, LACWWD 36's Saugus groundwater supplies shown in TABLE 4 8A.
- (n) Total demands with passive and active conservation from Table 2-10.
- (o) August 2022 updates based on the most recent engineering schedule for well projects

5.1.3 Single Dry Year Supplies and Demand

The water supplies and demands for the water suppliers over the 30-year planning period were analyzed in the event that a single-dry year occurs, based on the worst single dry year on record. Tab 5-3 summarizes the existing and planned supplies available to meet demands during a single-dry year. The demands shown include reductions from projected passive conservation savings, and both with and without active conservation savings. The demand during dry years was assumed to increase by 6 percent. Future demands include that of the Shadowbox Studios Development Project.

**Table 5-3
August 2022 Adjustments**

Projected Single-Dry Year Supplies and Demands (AF)						
	2025	2030	2035	2040	2045	2050
Existing Supplies						
Existing Groundwater ^(a)						
Alluvial Aquifer ^(r)	8,130	6,330	5,590	5,590	5,590	5,590
Saugus Formation ^(r)	16,320	17,880	17,880	17,880	17,880	17,880
Total Groundwater	24,450	24,210	23,470	23,470	23,470	23,470
Recycled Water ^(b)						
Total Recycled	450	450	450	450	450	450
Imported Water						
State Water Project ^(c)	4,760	4,760	4,760	4,760	4,760	4,760
Article 56 Carryover ^(s)	5,000					
Flexible Storage Accounts ^(d)	6,060	4,680	4,680	4,680	4,680	4,680
Buena Vista-Rosedale	11,000	11,000	11,000	11,000	11,000	11,000
Nickel Water - Newhall Land ^(e)	-	-	1,607	1,607	1,607	1,607
Yuba Accord Water ^(f)	1,000	-	-	-	-	-
Total Imported	27,820	20,440	22,047	22,047	22,047	22,047
Existing Banking and Exchange Programs						
Rosedale Rio-Bravo Bank ^(g)	10,000	10,000	10,000	10,000	10,000	10,000
Semitropic Bank ^(h)	5,000	5,000	5,000	5,000	5,000	5,000
Semitropic – Newhall Land Bank ^{(h)(i)}	-	-	4,950	4,950	4,950	4,950
Antelope Valley East Kern Water Agency Exchange ^(j)	-	-	-	-	-	-
United Water Conservation District Exchange ^(j)	-	-	-	-	-	-
Total Bank/Exchange	15,000	15,000	19,950	19,950	19,950	19,950
Total Existing Supplies^(p)	67,720	60,100	65,917	65,917	65,917	65,917
Planned Supplies						
Future and Recovered Groundwater ^(j)						
Alluvial Aquifer ^{(k)(r)}	11,580	17,020	20,500	20,500	20,500	20,500
Saugus Formation ^{(l)(r)}	7,540	15,920	15,920	15,920	15,920	15,920
Total Groundwater	19,120	32,940	36,420	36,420	36,420	36,420
Recycled Water ^(m)						
Total Recycled	1,849	3,696	5,091	6,498	7,499	8,511
Planned Banking Programs						
Rosedale Rio-Bravo Bank ⁽ⁿ⁾	-	10,000	10,000	10,000	10,000	10,000
Total Banking	0	10,000	10,000	10,000	10,000	10,000
Total Planned Supplies	20,969	46,636	51,511	52,918	53,919	54,931
Total Supplies (Existing and Planned)^(p)	88,689	106,736	117,428	118,835	119,836	120,848
Demands^{(o)(p)}						
Demands with passive conservation	87,000	94,700	103,500	110,600	116,200	122,000
Demands with passive and active conservation	81,000	86,600	94,000	99,200	103,400	107,100

Notes:

- (a) Existing groundwater supplies represent the quantity of groundwater available to be pumped with existing wells. Dry-year production represents anticipated maximum dry year production. Declines from 2025 pumping levels reflect transfer of normal year pumping from existing wells to future and recovered wells.
- (b) Existing recycled water is based on current average annual use.
- (c) SWP supplies are based on driest SWP delivery on record, 5% in 2014. Deliveries from DWR's 2019 DCR state single dry year are (7% -11%).
- (d) Includes both SCV Water and Ventura County entities flexible storage accounts. Extended term of agreement with Ventura County entities expires after 2025.
- (e) Existing Newhall Land supply committed under approved Newhall Ranch Specific Plan. Water is available from 2021 - 2034 to meet supply shortfalls associated with the Newhall Ranch Specific Plan. Assumed to be transferred to SCV Water once Newhall Ranch development is completed around 2035.
- (f) Supply shown is amount available in dry periods, after delivery losses. This supply would typically be used only during dry years and is available through 2025.
- (g) Supplies shown are annual amounts that can be withdrawn using existing firm withdrawal capacity and would typically be used only during dry years.
- (h) Existing Newhall Land supply. Assumed to be transferred to SCV Water during Newhall Ranch development by 2035.
- (i) Supplies shown are totals recoverable under the exchange and would typically be recovered only during dry years with SWP allocation greater than 30%.
- (j) Future and Recovered groundwater supplies include recovered impacted wells and new groundwater well capacity that may be required by SCV Water's production objectives in the Alluvial Aquifer and the Saugus Formation. When combined with existing SCV Water and non-SCV Water groundwater supplies, total groundwater production remains within the sustainable ranges identified in Tables 4-10 and 4-11 and is within the groundwater basin yields per the 2020 SCV-GSA Water Budget Development Tech Memo (GSI 2020) and the updated Basin Yield Analysis (LSC & GSI 2009).
- (k) Future and Recovered Alluvial groundwater include PFAS, and perchlorate impacted alluvial wells, one replacement well (S 9), and future wells, including those for Newhall Ranch Specific Plan. Schedule for recovered well capacity based on Groundwater Treatment Implementation Plan Technical Memorandum, Kennedy Jenks 2021 Appendix M. 2025 adjustments based on January 2022 engineering project schedule updates).
- (l) Future and Recovered Saugus wells include perchlorate impacted Well 205, two replacement wells (Saugus 3 & 4), and up to four new wells (Saugus 5-8) planned to provide additional dry-year supply. New dry-year wells would not typically be operated during average/normal years.
- (m) Planned recycled water is the total projected recycled water use less existing use. Projections reflect demands that can be cost-effectively served with projected supplies. Refer to Section 3 for additional details on recycled water demands and supplies.
- (n) Firm withdrawal capacity under existing Rosedale Rio-Bravo Banking Program to be expanded by 10,000 AFY by 2030 (for a combined total of 20,000 AFY).
- (o) Demands assume a 6% increase above normal demand during dry years.
- (p) For completeness, LAWWD36 sales are included in demands and supplies. Breakdown of LACWWD 36 and SCV Water Demands are shown in Table 2-2. Further, LACWWD36's Saugus groundwater supplies are shown in Table 3-4B.
- (q) Future demands include that of the Shadowbox Studios Development Project.
- (r) August 2022 updates based on most recent engineering schedule for well projects
- (s) Carryover supply updates based on 2023-2025 Operating Plans assuming consistent 5% SWP allocation.

5.1.4 Multiple Dry Year Supplies and Demand

The water supplies and demands over the 30-year planning period were analyzed in the event that a five-year dry period occurs, similar to the drought that occurred during the years 1988-1992. Table 5-4 summarizes the existing and planned supplies available to meet demands during a five-year dry period. Supply volumes shown represent averages for the consecutive five-year period, assuming each 5-year interval (2025, 2030, etc.) is the midpoint of the five-year period. The demands shown include reductions from projected passive conservation savings, and both with and without active conservation savings. As in the single-dry year scenario, demand during dry years was assumed to increase by 6 percent. Future demands include that of the Shadowbox Studios Development Project.

**TABLE 5-4
August 2022 Adjustments**

Supplies Available	2025	2030	2035	2040	2045	2050
Existing Supplies						
Existing Groundwater(a)						
Alluvial Aquifer(r)	7,800	6,720	5,890	5,590	5,590	5,590
Saugus Formation(r)	15,970	17,610	17,610	17,610	17,610	17,610
Total Groundwater	23,770	24,330	23,500	23,200	23,200	23,200
Recycled Water(b)						
Total Recycled	450	450	450	450	450	450
Imported Water						
State Water Project(c)	24,040	24,090	24,130	24,180	24,180	24,180
Carryover (Article 56) (r)(s)	5,000					
Flexible Storage Accounts(d)	4,980	4,680	4,680	4,680	4,680	4,560
Buena Vista-Rosedale	11,000	11,000	11,000	11,000	11,000	11,000
Nickel Water - Newhall Land(e)	0	0	960	1,610	1,610	1,610
Yuba Accord(f)	600	0	0	0	0	0
Total Imported	45,620	39,770	40,770	41,470	41,470	41,350
Banking and Exchange Programs						
Rosedale Rio-Bravo Bank(g)	10,000	10,000	10,000	10,000	10,000	10,000
Semitropic Bank(h)	5,000	5,000	5,000	5,000	4,929	1,859
Semitropic - Newhall Land Bank(i)	0	0	2,970	4,950	4,950	4,950
AVEK Exchange(j)	450	450	0	0	0	0
UWCD Exchange(j)	100	100	0	0	0	0
IRWD Short Term Exchange(j)(r)	1,000	0	0	0	0	0
Total Bank/Exchange	16,550	15,550	17,970	19,950	19,879	16,809
Total Existing Supplies(q)	86,390	80,100	82,690	85,070	84,999	81,809
Planned Supplies						
Future and Recovered Groundwater(k)						
Alluvial Aquifer(l)(r)	11,480	16,310	19,800	20,500	20,500	20,500
Saugus Formation(m)(r)	5,950	8,020	8,020	8,021	8,021	8,021
Total Groundwater	17,430	24,330	27,820	28,521	28,521	28,521
Recycled Water(n)	1,823	3,603	5,045	6,498	7,499	8,389
Total Recycled	1,823	3,603	5,045	6,498	7,499	8,389
Planned Banking Programs						
Rosedale Rio-Bravo Bank(o)	0	6,000	10,000	10,000	10,000	10,000
Total Banking	0	6,000	10,000	10,000	10,000	10,000
Total Planned Supplies	19,253	33,933	42,865	45,019	46,020	46,910
Total Existing and Planned Supplies	105,643	114,033	125,555	130,089	131,020	128,720
Demands with Passive Conservation(p)(q)	83,570	91,380	99,670	106,660	112,100	117,010
Demands with Active Conservation(p)(q)	77,830	83,620	90,570	95,780	99,670	102,870

Notes:

- (a) Existing groundwater supplies represent the quantity of groundwater available to be pumped with existing wells. Dry-year production represents anticipated maximum dry year production. Declines from 2025 pumping levels reflect transfer of normal year pumping from existing wells to future and recovered wells
- (b) Existing recycled water is based on current average annual use.
- (c) SWP supplies based on 1988-1992 hydrology from 2019 DCR interpolated from 2020-2040 from current to proposed future SWP supplies.
- (d) Includes both SCV Water and Ventura County entities flexible storage accounts through 2025 and only SCV Water portion beyond 2025.
- (e) Existing Newhall Land supply committed under approved Newhall Ranch Specific Plan. Water is available from 2021 -2034 to meet supply shortfalls associated with the Newhall Ranch Specific Plan. Assumed to be transferred to SCV Water once Newhall Ranch development is completed around 2035.
- (f) 1,000 AFY assumed to be available during dry and critically dry years. Lower quantity in table reflects averaging of supply over the five-year period. This supply is only available through 2025.
- (g) SCV Water has an existing firm withdrawal capacity of 10,000 AFY and a storage capacity of 100,000 AF. There is currently (as of January 2021) 98,800 AF of recoverable Water in storage.
- (h) SCV Water has a maximum firm withdrawal capacity of 5,000 AFY and a storage capacity of 15,000 AF. Additionally, SCV Water has 40,270 AF of recoverable Water stored which may be recovered using this withdrawal capacity.
- (i) Existing Newhall Land supply. Assumed to be transferred to SCV Water during Newhall Ranch development by 2035.
- (j) Exchange recovery was assumed to occur one year during the five-year dry period, for an average annual supply of one-fifth of the total recoverable water available (total recoverable is 2,250 AF from Antelope Valley East Kern Water Agency (AVEK) and 500 AF from United Water Conservation District exchange programs, and an options for 5,000 AF in 2023 from Irvine Ranch Water District Short-Term Exchange Agreement).
- (k) Future and Recovered groundwater supplies include recovered impacted wells and new groundwater well capacity that may be required by SCV Water's production objectives in the Alluvial Aquifer and the Saugus Formation. When combined with existing SCV Water and non-SCV Water groundwater supplies, total groundwater production remains within the sustainable ranges identified in Tables 4-9 and 4-10 and is within the groundwater basin yields per the 2020 SCV-GSA Draft Water Budget Development Tech Memo (GSI 2020) and the updated Basin Yield Analysis (LSC & GSI 2009).
- (l) Future Category includes all wells restored from PFAS and Perchlorate water quality issues, and other future alluvial wells including those associated with development under the Newhall Ranch Specific Plan. Schedule for recovered well capacity based on Groundwater Treatment Implementation Plan Technical Memorandum, Kennedy Jenks 2021 Appendix M. (Updated numbers based on most current engineering schedule)
- (m) This includes Saugus perchlorate impacted Well 205, two replacement wells (Saugus 3 & 4), and up to four new wells (Saugus 5-8) planned to provide additional dry-year supply. New dry-year wells would not typically be operated during average/normal years.
- (n) Planned recycled water is the total projected recycled water use from Table 3-10 less existing use. Projections reflect demands that can be cost-effectively served with projected supplies. Refer to Section 3 for additional details on recycled water demands and supplies.
- (o) Firm withdrawal capacity under existing Rosedale Rio-Bravo Banking Program to be expanded by 10,000 AFY by 2030 (for a combined total of 20,000 AFY).
- (p) Demands are weather adjusted for dry 1988-1992 hydrology.
- (q) For completeness, LAWWD36 sales are included in demands and supplies. Breakdown of LACWWD 36 and SCV Water Demands are shown in Table 2-2. Further, LACWWD 36's Saugus groundwater supplies are shown in Table 3-4B.
- (r) August 2022 updates based on most recent engineering schedule for well projects.
- (s) Carryover supply updates based on 2023-2025 Operating Plans assuming consistent 5% SWP allocation.

5.2 Additional Water Supply Reliability Analysis

As discussed in Section 4.10, SCV Water has undertaken additional analysis of its water supply reliability beyond the Normal, Single Dry-Year and Multiple Dry-Year analysis provided for the 2020 UWMP, and this Water Supply Assessment. This was done with the 2021 update to its Water Supply Reliability Plan (Plan). The Plan uses an analytic spreadsheet model that incorporates the anticipated increase in demand due to growth and climate change (through 2050) and models the variability of hydrology both locally and from imported sources. For each hydrologic sequence, the model steps through each year of the study period, comparing annual supplies to demands and operating SCV Water storage programs as needed, adding to storage in years when supplies exceed demand, and withdrawing from storage when demand exceeds supplies. Results from the multiple hydrologic sequences are then compiled and summarized to

5-12

provide a statistical assessment of the reliability of SCV Water's supplies and storage programs to meet its projected demands over the study period.

The reliability analysis conducted in the Plan is more rigorous and conservative than that contained in the 2020 UWMP and in Section 5.1 of this WSA. The Plan models the operation of SCV Water's supply portfolio through the full 82-year historical hydrologic period and incorporates projected storage balances when determining the quantity of water available from a banking program to meet water demands during dry periods. Further, while UWMP Section 5.2 incorporated a gradual decline in SWP reliability between 2020 and 2040 due to climate change, the Plan's modeling is based on SWP hydrology adjusted to reflect 2040 climate change, being applied to all years in the study period.

The Plan analyzed various scenarios analyses, which analysis can be used to answer several questions including:

1. How long current facilities could be relied upon to achieve reliability?
2. If the mix of existing and proposed facilities in the UWMP achieved reliability through 2050?
3. If certain future facilities were not constructed, (specifically some or all of the new Saugus Formation wells were either not constructed or otherwise unavailable) would alternative programs that SCV Water is investigating be able to achieve reliability?

With respect to the first question identified above, the analysis shows that current supplies (including recovered groundwater capacity) along with active conservation will be sufficient until 2040.

Regarding the second question, to achieve reliability in subsequent years, additional investments in those programs and facilities identified in the UWMP (Scenarios 1) would be sufficient to achieve reliability through 2050.

As to the third question, Scenarios 2-5 demonstrate that alternative programs to those contained in the UWMP could offer different paths to achieve reliability or if implemented in addition to the UWMP could provide additional supplies in excess of demand.

Supply Reliability

As discussed above, the analysis contained in the Plan represents a more robust and conservative analysis than that contained in Section 5.1. Nevertheless, the conclusions related to the ability of SWC Water to reliably meet water demands (including the Shadowbox Studios Development) are consistent. If SCW water continues to implement active water conservation measures, conjunctively use its imported water, groundwater, and water banking facilities, and invests in future water supply facilities as identified in the 2020 UWMP it will reliably meet water demands in its service area through 2050. The ability to implement other alternative water supply programs identified in the Plan's analysis demonstrates a robustness to this conclusion as alternatives exist should some of the future water supplies identified in the 2020 UWMP become unattainable.

5.3 Conclusion

As set forth in this WSA, SCV Water has evaluated the long-term water needs (water demand) within its service area and has compared these needs against existing and planned water supplies. Demand projections are based on applicable population projections and county and city land use plans, and account for conservation as well as climate change impacts and other relevant factors. This WSA concludes that

the total projected water supplies available to the SCV Water service area over the 30-year projection during normal, single-dry, and multiple-dry year (5-year drought) periods are sufficient to meet the projected demands associated with the proposed Shadowbox Studios Development Project, in addition to existing and other planned future uses, including agricultural and industrial uses, throughout the Valley, provided that SCV Water continues to utilize available SWP Table A Amounts, and continues to incorporate conjunctive use (coordinated use of surface water and groundwater), water conservation, water transfers, recycled water, and water banking as part of the total water supply portfolio and management approach to long-term water supply planning and strategy.

Section 6: References Used or Relied Upon in Preparing WSA

This WSA used or relied on information contained in the documents listed below. Documents may be available online at the links provided or by contacting the SCV Water - Water Resources Department at (661) 297-1600. The documents are part of SCV Water's record for the preparation of this WSA.

California Department of Water Resources, December 2021. 2021 Draft State Water Project Delivery Capability Report, available at: <https://water.ca.gov/Library/Modeling-and-Analysis/Central-Valley-models-and-tools/CalSim-3/DCR2021>.

California Department of Water Resources, July 2020. 2019 State Water Project Delivery Capability Report, available at: <https://water.ca.gov/Library/Modeling-and-Analysis/Central-Valley-models-and-tools/CalSim-II/DCR2019>.

California Department of Water Resources. 2018. Delta Flood Emergency Plan.

California Department of Water Resources. 2018a. Guidance for Climate Change Data Use During Groundwater Sustainability Plan Development, available at: https://water.ca.gov/-/media/DWR-Website/Web-Pages/Programs/Groundwater-Management/Sustainable-Groundwater-Management/Best-Management-Practices-and-Guidance-Documents/Files/Climate-Change-Guidance_Final_ay_19.pdf.

California Department of Water Resources. November 2011. "Climate Change Handbook for Regional Water Planning", available at: https://www.epa.gov/sites/default/files/2021-03/documents/climate_change_handbook_regional_water_planning.pdf

California Department of Water Resources, 2016. Bulletin 118 – Update 2016, available at: https://cawaterlibrary.net/wp-content/uploads/2017/05/Bulletin_118_Interim_Update_2016.pdf

California Department of Water Resources and the Army Corps of Engineers, 2019. Delta Emergency Integration Plan.

California Department of Water Resources Climate Change Technical Advisory Group (CCTAG). 2015. Producing Scientific and Strategic Guidance for California's Department of Water Resources, available at: <https://water.ca.gov/-/media/DWR-Website/Web-Pages/Programs/All-Programs/Climate-Change-Program/Climate-Program-Activities/Files/Reports/Perspectives-Guidance-Climate-Change-Analysis.pdf>

California Division of Drinking Water, November 1997. Policy Memo 97-005: Policy Guidance for Direct Domestic Use of Extremely Impaired Sources, available at: https://www.waterboards.ca.gov/drinking_water/certlic/drinkingwater/docs/process_memo_97-005-r2020_v7.pdf

California Ocean Protection Council. 2018. Sea-Level Rise Guidance, available at: https://opc.ca.gov/webmaster/ftp/pdf/agenda_items/20180314/Item3_Exhibit-A OPC SLR Guidance-rd3.pdf

- California Office of Emergency Services (Cal OES). 2018. Northern California Catastrophic Flood Response Plan, available at: <https://www.caloes.ca.gov/cal-oes-divisions/planning-preparedness/catastrophic-planning>
- California State Water Resources Control Board, March 2000. Revised Water Right Decision 1641, available at: https://www.waterboards.ca.gov/waterrights/board_decisions/adopted_orders/decisions/d1600_d1649/wrd1641_1999dec29.pdf
- Carollo Engineers, June 2015. Santa Clarita Valley Water Agency Water Resources Reconnaissance Study, available at: <http://yourscvwater.com/water-supply-assessments>
- CH2M Hill, 2004a. Regional Ground water Flow Model for the Santa Clarita Valley, Model Development and Calibration. April, <http://yourscvwater.com/water-supply-assessments>
- CH2M Hill, 2004 b. Analysis of Perchlorate Containment in Ground water Near the Whittaker-Bermite Property, Santa Clarita, California, Prepared in support of the 97-005 Permit Application, December, available at: <http://yourscvwater.com/water-supply-assessments>
- CH2M Hill, 2005a. Technical Memorandum, Calibration Update of the Regional Ground Water Flow Model for the Santa Clarita Valley, Santa Clarita, California, August, available at: <http://yourscvwater.com/water-supply-assessments>
- CH2M Hill and Luhdorff & Scalmanini, Consulting Engineers, 2005. Analysis of Ground Water Basin Yield, Upper Santa Clara River Groundwater Basin, East Subbasin, Los Angeles County, California, prepared for Upper Basin Water Purveyors, August, available at: <https://nrm.dfg.ca.gov/FileHandler.ashx?DocumentID=11086>
- Geoscience. 2014. Salt and Nutrient Management Plan for the Upper Santa Clara River Groundwater Basin Volumes 1 and 2, available at: <http://yourscvwater.com/water-supply-assessments>
- Geosyntec Water Supply Reliability Plan, 2021, available at: <http://yourscvwater.com/water-supply-assessments>
- GSI Water Solutions (GSI), Inc. 2022. Santa Clara River Valley East Groundwater Sustainability Plan. Available at: <https://scvgsa.org/wp-content/uploads/2021/12/SCV-GSP-Sections-Combined-20211217.pdf>
- GSI Water Solutions (GSI), Inc. 2020a. Water Budget Development for the Santa Clara River Valley East Groundwater Subbasin, Draft Technical Memorandum, available at: <https://yourscvwater.com/wp-content/uploads/2021/04/SCV-GSA-Draft-Tech-Memo-%E2%80%93-Water-Budget-Development.pdf>
- GSI Water Solutions, Inc. 2020. Development of a Numerical Groundwater Flow Model for the Santa Clara River Valley East Groundwater Subbasin, available at: https://scvgsa.org/wp-content/uploads/2020/11/01_DRAFT-Mdl-Dev-Rpt-Clean-Text-2020-09-22.pdf
- GSI & LSCE. 2014. Draft Report: Perchlorate Containment Plan for Well V201 and Saugus Formation Groundwater in the Santa Clarita Valley (Task 3 of the Well V201 Restoration Program), available at: <http://yourscvwater.com/water-supply-assessments>

- Kennedy/Jenks Consultants. 2021. Santa Clarita Valley Water Agency Groundwater Treatment Implementation Plan. April, available at: https://yourscvwater.com/wp-content/uploads/2021/04/App-C-Final-SCVWA_Groundwater-treatment_Imp-Plan-Rpt4-19-2021.pdf
- Kennedy/Jenks Consultants. 2021. Santa Clarita Valley 2020 Urban Water Management Plan. July, available at: <https://yourscvwater.com/uwmp/>
- Kennedy/Jenks Consultants. 2002. Recycled Water Master Plan Update, available at: <http://yourscvwater.com/water-supply-assessments>
- Kennedy/Jenks Consultants. 2016a. Recycled Water Master Plan Update, available at: https://yourscvwater.com/wp-content/uploads/2021/04/CLWA_RWMP_Final_Sept2016_submit.pdf
- Kennedy/Jenks Consultants. 2016b. Santa Clarita Valley Recycled Water Rules and Regulations Handbook. Adopted by the SCV Water Board of Directors on 10 February 2016, available at: https://yourscvwater.com/wp-content/uploads/2018/01/SCV_RW_RulesRegs_Handbook_FINAL_Feb2016-2.pdf
- Kennedy/Jenks Consultants. 2015. Final Preliminary Design Report for the Recycled Water System Phase 2B, available at: <http://yourscvwater.com/water-supply-assessments>
- Kennedy/Jenks Consultants. 2014 and 2018 Update. Integrated Regional Water Management Plan for the Upper Santa Clara River Region, available at: <https://dpw.lacounty.gov/wmd/scr/docs/The%202014%20Update%20of%20the%20IRWMP/1.%20USCR%20IRWMP%20Final%20February%202014.pdf> and <https://dpw.lacounty.gov/wmd/scr/docs/2018%20Draft%20Amendments%20to%20USCR%202014%20IRWM%20Plan.PDF>
- Los Angeles Regional Water Quality Control Board (LARWQCB). 1994. Water Quality Control Plan: Los Angeles Region Basin Plan for the Coastal Watersheds of Los Angeles and Ventura Counties, 2020 version available at: https://www.waterboards.ca.gov/losangeles/water_issues/programs/basin_plan/basin_plan_documentation.html
- Luhdorff & Scalmanini, Consulting Engineers, 2021. 2020 Santa Clarita Valley Water Report, available at: <https://yourscvwater.com/wp-content/uploads/2021/09/2020-Santa-Clarita-Valley-Water-Report.pdf>
- Luhdorff & Scalmanini, Consulting Engineers, 2020. 2019 Santa Clarita Valley Water Report, available at: <https://yourscvwater.com/wp-content/uploads/2020/08/2019-Santa-Clarita-Valley-Water-Report.pdf>
- Luhdorff & Scalmanini and GSI Water Solutions. August 2009. Analysis of Ground Water Supplies and Ground water Basin Yield, Upper Santa Clara River Ground Water Basin, East Subbasin, available at: <https://nrm.dfg.ca.gov/FileHandler.ashx?DocumentID=21469>

- Luhdorff and Scalmanini, 2005. Consulting Engineers, Impact and Response to Perchlorate Contamination, Valencia Water Company Well Q2, prepared for Valencia Water Company, available at: <http://yourscvwater.com/water-supply-assessments>
- Luhdorff & Scalmanini, Consulting Engineers, December 2003. Ground Water Management Plan for the Santa Clara Valley Ground Water Basin, East Subbasin, available at: <https://yourscvwater.com/wp-content/uploads/2020/05/CLWA-Groundwater-Management-Plan-December-2003.pdf>
- M&N. 2007. Levee Repair, Channel Barrier and Transfer Facility Concept Analyses to Support Emergency Preparedness Planning.
- Maddaus Water Management (MWM), Inc. 2021. Draft 2021 SCV Demand Study: Land-Use-Based Demand Forecast Analysis. April, available at: <http://yourscvwater.com/water-supply-assessments>
- Maddaus Water Management (MWM), Inc. 2016. SCV Demand Study Update: Land-Use Based Demand Forecast, Final Technical Memorandum No.2. March, available at: <http://yourscvwater.com/water-supply-assessments>
- Maddaus Water Management (MWM), Inc. 2015. SCV Family of Water Supplies Water Use Efficiency Strategic Plan. June, available at: <http://yourscvwater.com/water-supply-assessments>
- Richard C. Slade & Associates, LLC, 2001 Update Report, Hydrogeologic Conditions in the Alluvial and Saugus Formation Aquifer Systems, prepared for Santa Clarita Valley Water Purveyors, July 2002, available at: <http://yourscvwater.com/water-supply-assessments>
- Sanitation Districts of Los Angeles County, 2013. Santa Clarita Valley Sanitation District Chloride Compliance Facilities Plan and Environmental Impact Report. October, available at: <https://www.lacsd.org/services/wastewater-programs-permits/santa-clarita-chloride-compliance/final-recirculated-scvsd-chloride-compliance-eir-separation-of-recycled-water-project/-folder-90>
- Santa Clarita Valley Water Agency (SCVWA). 2021. Water Supply Reliability Plan Update, prepared by Geosyntec, available at: https://yourscvwater.com/wp-content/uploads/2021/04/SCV-Water-Reliability-Plan-update_2021-Master_DRAFT-1.pdf.
- Santa Clarita Valley Water Agency (SCVWA). 2021. 2020 Urban Water Management Plan for Santa Clarita Valley Water Agency. June. Prepared by Kennedy Jenks Consultants, available at: <https://yourscvwater.com/uwmp/>
- Santa Clarita Valley Water Agency (SCVWA). 2021. Final Water Shortage Contingency Plan. June, available at: https://yourscvwater.com/wp-content/uploads/2021/07/2020-SCV-Water_Water-Shortage-Contingency-Plan_Final.pdf
- Santa Clarita Valley Water Agency (SCVWA), July 2015. Castaic Lake Water Agency 2015 Strategic Plan, 2017 Addendum, available at: <http://yourscvwater.com/water-supply-assessments>

- Sites Program Management Team. 2020. Sites Reservoir Value Planning Report, available at: <https://3hm5en24txyp2e4cxyxaklbs-wpengine.netdna-ssl.com/wp-content/uploads/2020/04/INT-REP-Value-Planning-Appraisal-Report-FinalV2Compressed.pdf>.
- Slade, R. C. Hydrogeologic Assessment of the Saugus Formation in the Santa Clara Valley of Los Angeles County, California, Vols. I and II, prepared for Castaic Lake Water Agency, 1988, available at: <http://yourscvwater.com/water-supply-assessments>
- Slade, R. C. Hydrogeologic Investigation of Perennial Yield and Artificial Recharge Potential of the Alluvial Sediments in the Santa Clarita River Valley of Los Angeles County, California, Vols. I and II, prepared for Upper Santa Clara Water Committee, 1986.
- Wang, Jianzhong, Hongbing Yin, Erik Reyes, Tara Smith, Francis Chung (California Department of Water Resources). 2018. Mean and Extreme Climate Change Impacts on the State Water Project. California's Fourth Climate Change Assessment. Publication number: CCCA4-EXT-2018-004, available at: https://www.energy.ca.gov/sites/default/files/2019-12/Water_CCCA4-EXT-2018-004_ada.pdf
- Woodard and Curran, 2021. Recycled Water Seasonal Storage Study Technical Memo, January 14, 2021, available at: <http://yourscvwater.com/water-supply-assessments>
- Santa Clarita Valley Water Agency State Water Contract with the Department of Water Resources (DWR), available at: <http://yourscvwater.com/water-supply-assessments>
- Santa Clarita Valley Water Agency 2014, Agreement in Principle with the Department of Water Resources for extension of contracts, September 12, 2014, available at: <http://yourscvwater.com/water-supply-assessments>
- Department of Water Resources Contract Extension Amendment, February 2019, available at: https://water.ca.gov/-/media/DWR-Website/Web-Pages/Programs/State-Water-Project/Management/Water-Supply-Contract-Extension/Files/Santa-Clarita-Valley-Water-Agency-WSC-Extension-Amendment-022619_a_y19.pdf
- Santa Clarita Valley Water Agency 2015, Agreement with Ventura County for use of their Flexible Storage Account, available at: <http://yourscvwater.com/water-supply-assessments>
- Department of Water Resources Coordinated Operations Agreement with the Bureau of Reclamation, 1986, available at: https://cawaterlibrary.net/wp-content/uploads/2017/09/agreementbetween00wash_bw.pdf
- Department of Water Resources Addendum to the Coordinated Operations Agreement with the Bureau of Reclamation, December 2018, available at: https://www.usbr.gov/mp/nepa/includes/documentShow.php?Doc_ID=36503
- Santa Clarita Valley Water Agency Transfer Agreement with Buena Vista Water Storage District and Rosedale Rio Bravo Water Storage District, available at: <http://yourscvwater.com/water-supply-assessments>
- Santa Clarita Valley Water Agency 2018, Yuba Accord Agreement, available at: <http://yourscvwater.com/water-supply-assessments>

- Santa Clarita Valley Water Agency Two-for-One Water Exchange Program with Antelope Valley-East Kern Water Agency (AVEK), 2019, available at: <http://yourscvwater.com/water-supply-assessments>
- Santa Clarita Valley Water Agency Two-for-One Water Exchange Program with United Water Conservation District, 2019, available at: <http://yourscvwater.com/water-supply-assessments>
- Santa Clarita Valley Water Agency Agreement with Semitropic Water Storage District for participation in the Storage Water Recovery Unit (SWRU), 2015, available at: <http://yourscvwater.com/water-supply-assessments>
- Santa Clarita Valley Water Agency Water Banking and Exchange Program Agreement with Rosedale Rio Bravo Water Storage District, 2005-2015, available at: <http://yourscvwater.com/water-supply-assessments>
- Santa Clarita Valley Water Agency contract with the Santa Clarita Valley Sanitation District, available at: <http://yourscvwater.com/water-supply-assessments>
- Santa Clarita Valley Water Agency, Biennial Budget for FY 2021/22, and FY 2022/23, available at: <http://yourscvwater.com/water-supply-assessments>
- Newhall Land and Farming Agreement with Semitropic WSD for Water Banking Exchange Program 2001, available at: <http://yourscvwater.com/water-supply-assessments>
- Newhall Land and Farming Company 2022, Nickel Water Agreement, available at: <http://yourscvwater.com/water-supply-assessments>

[This page intentionally left blank.]

Appendix A - Site Plan

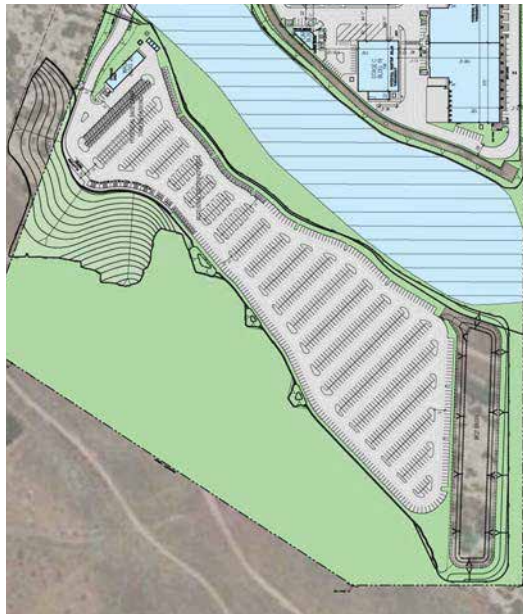

Location Map

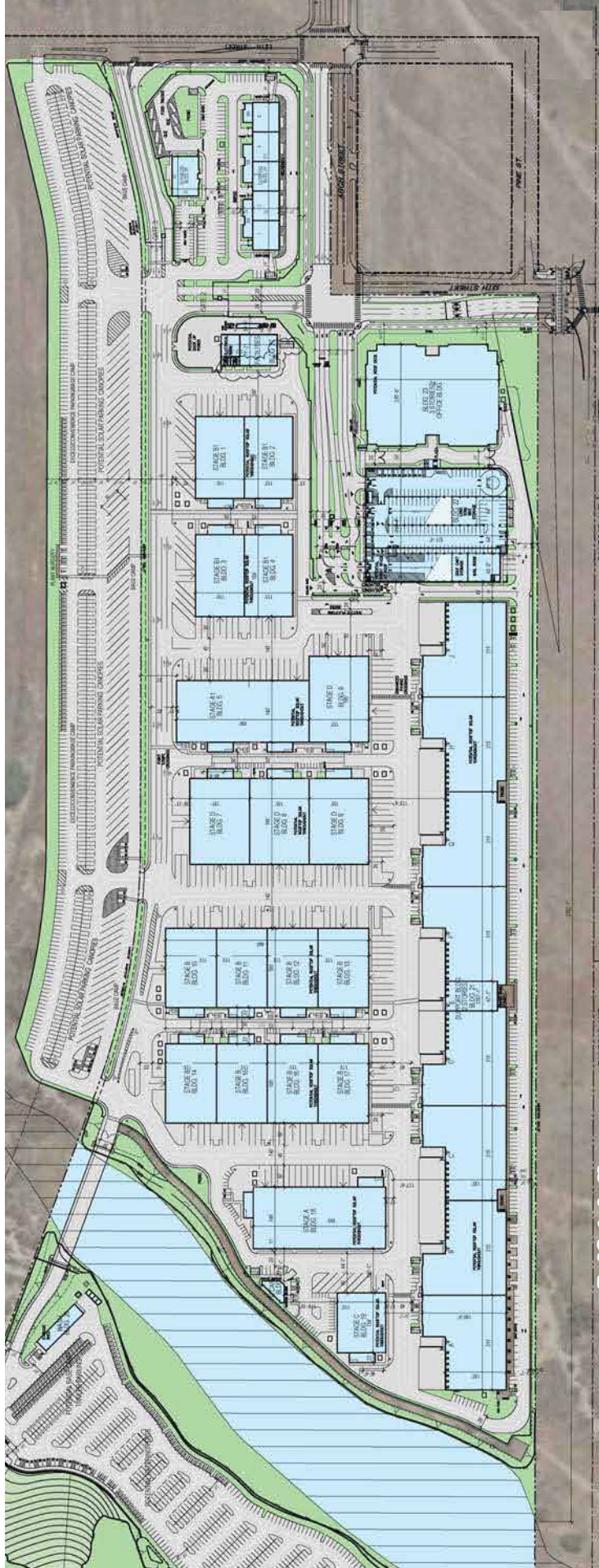

Source: GAA Architects, Inc. 2021



Exhibit 3
Proposed Site Plan

Michael Baker
INTERNATIONAL



SCV
WATER

Shadowbox Studios Development Water Supply Assessment

Water Resources and Watershed Committee Meeting
Sept 14, 2022
Rick Vasilopoulos



Presentation Outline

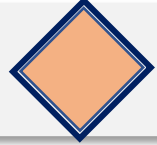

SB 610 WSA Process and Requirements



Project Description & Water Demands



Available and Anticipated Water Supplies



Review and Management of Demand and Water Supply Risks



Review of SCV Water's Historical Operations



Supply and Demand Comparisons



Conclusions and Recommendations



The Water Supply Assessment

- The WSA statute is intended to better link land use decision-making and water supply availability
- Unlike UWMPs, WSAs are project-specific analyses that are required when a city or county lead agency determines the project is subject to CEQA
- WSAs must determine whether projected supplies will be available during normal, single-dry, and multiple dry years to meet the demand of the project as well as existing and planned future uses over 20-year planning horizon
- Projected supplies can include future planned supplies
- Water supplier's Board of Directors are required to adopt a WSA
- If the water supplier concludes that water supplies are, or will be, insufficient, the water supplier "... shall provide to the City or County its plans for acquiring additional water supplies"
- An adopted WSA is not subject to direct legal challenge and can only be challenged as part of a CEQA action against the lead agency



SB 610 Water Supply Assessment Process

Project application sent to Lead Agency who determines whether the project is subject to CEQA and SB 610 requirements

Lead Agency contacts the Project's service area water supplier, and the supplier must prepare the WSA within 90 days, but can request extension

Water supplier prepares analysis of the Project's water demands and compiles a supportive record using the most recent Urban Water Management Plan

Water Supplier's Board of Directors determines if supplies are sufficient for the proposed Project and sends Assessment with findings to the Lead Agency



Shadowbox Studios Project Description

- The Project is within SCV Water's service area.
- The Project consists of:
 - 473,000 sf of sound stages
 - 561,500 sf of workshops, warehouses and support uses
 - 221,000 sf of production and administrative offices
 - 37,500 sf of catering and specialty services
 - 17.1 acres of landscape irrigation



Project Location

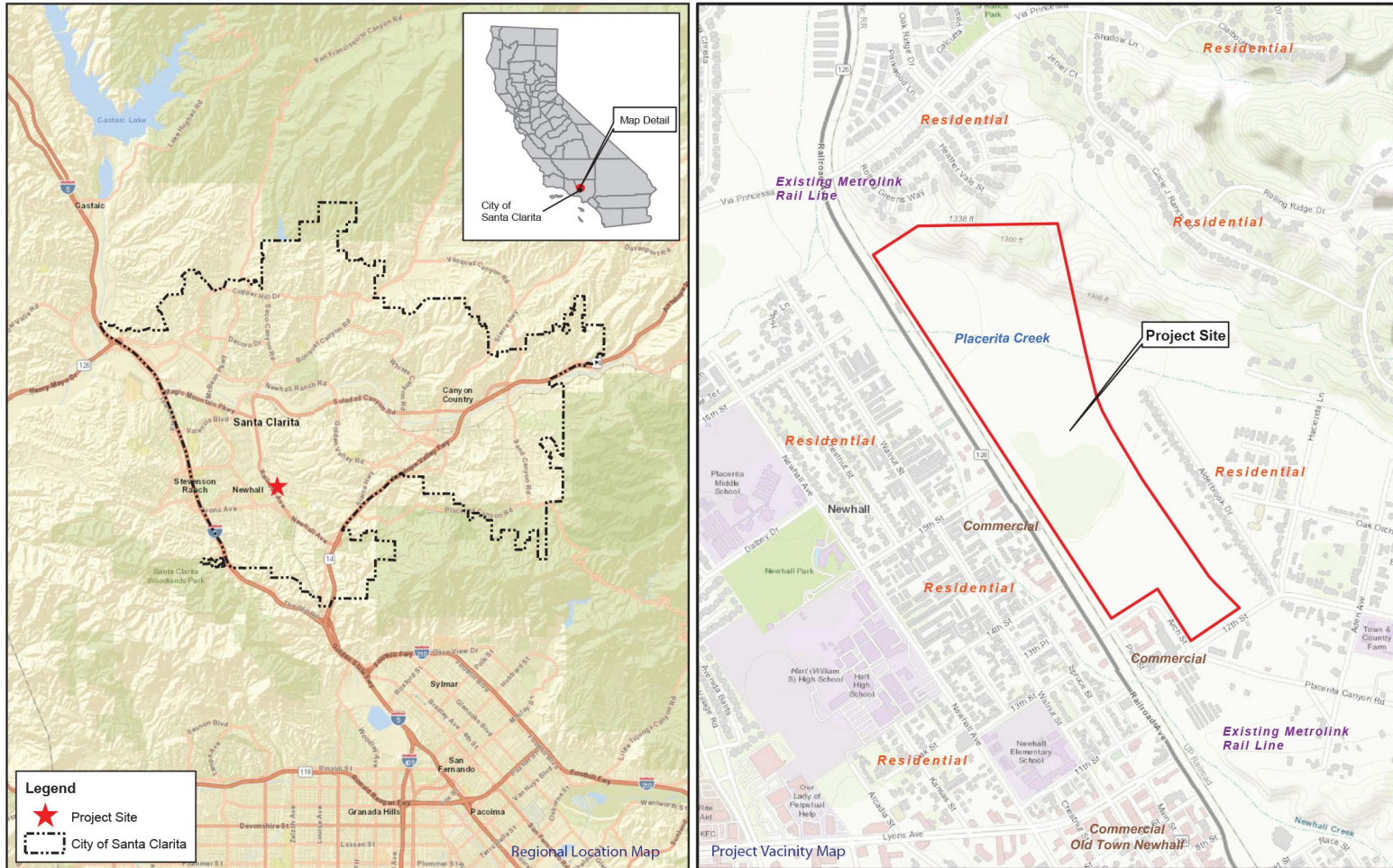

The Shadowbox Studios Development is located between Via Princessa Avenue and 12th Street east of the Railroad Avenue



SB 610 Requirement:

Shadowbox Studios

Demand Assessment Analysis

WATER DEMAND ESTIMATES - SHADOWBOX STUDIOS DEVELOPMENT			
Unit	# of units	Unit Type	Demand (AFY)
Landscape Irrigation	17.1	Acres	55.71
Commercial/Office	266	TSF	64.8
Industrial	1018	TSF	76.2
Total Average Year Demands (AFY)			197
Projected Single Dry Year Demands (AFY)			209
Projected Multiple Dry Year Demands (AFY)			201

Note: Totals reflect additional overwatering factor of 26.5% for residential and 25.6% for commercial uses and 3.77% climate change factor



Build-out Water Demand Methodology

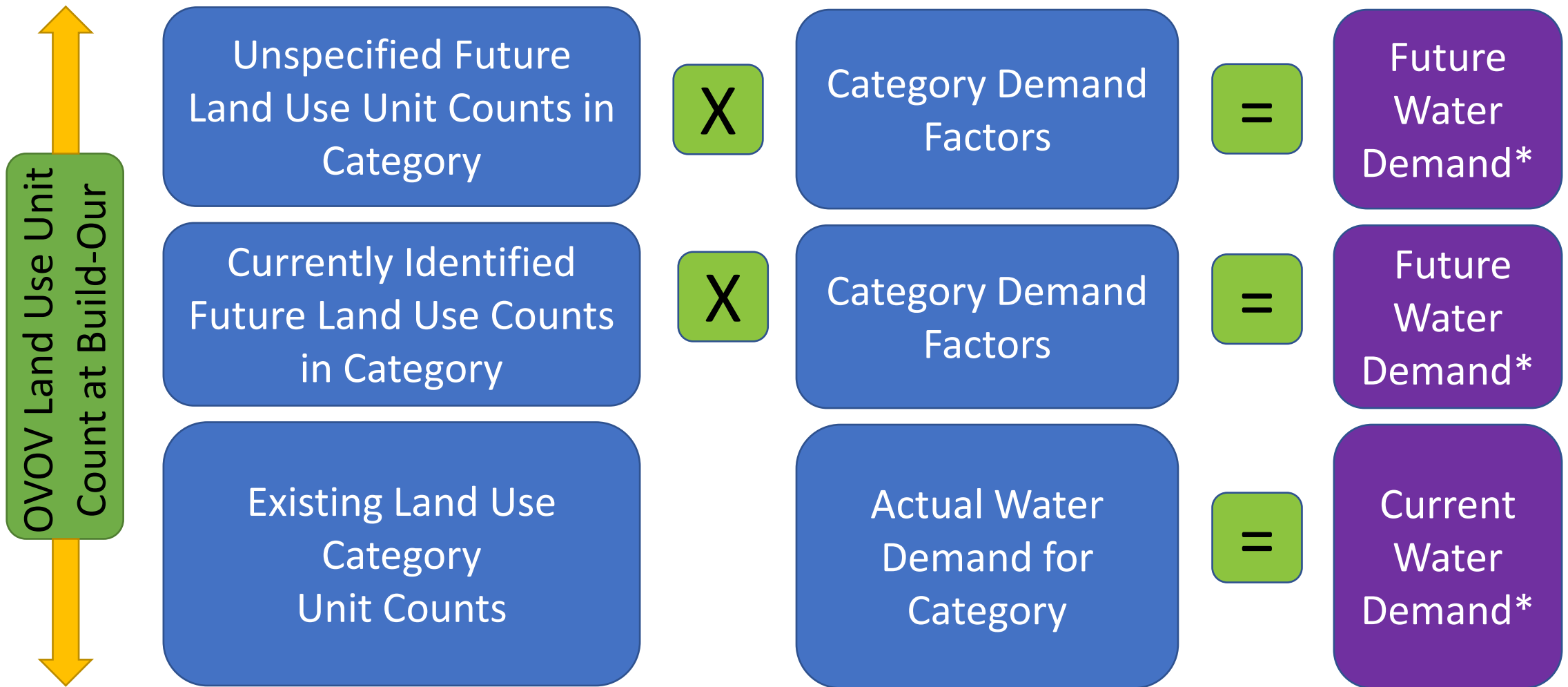

* Adjusted Annually for Climate Change and Conservation



Valley Build-out Demand Calculations

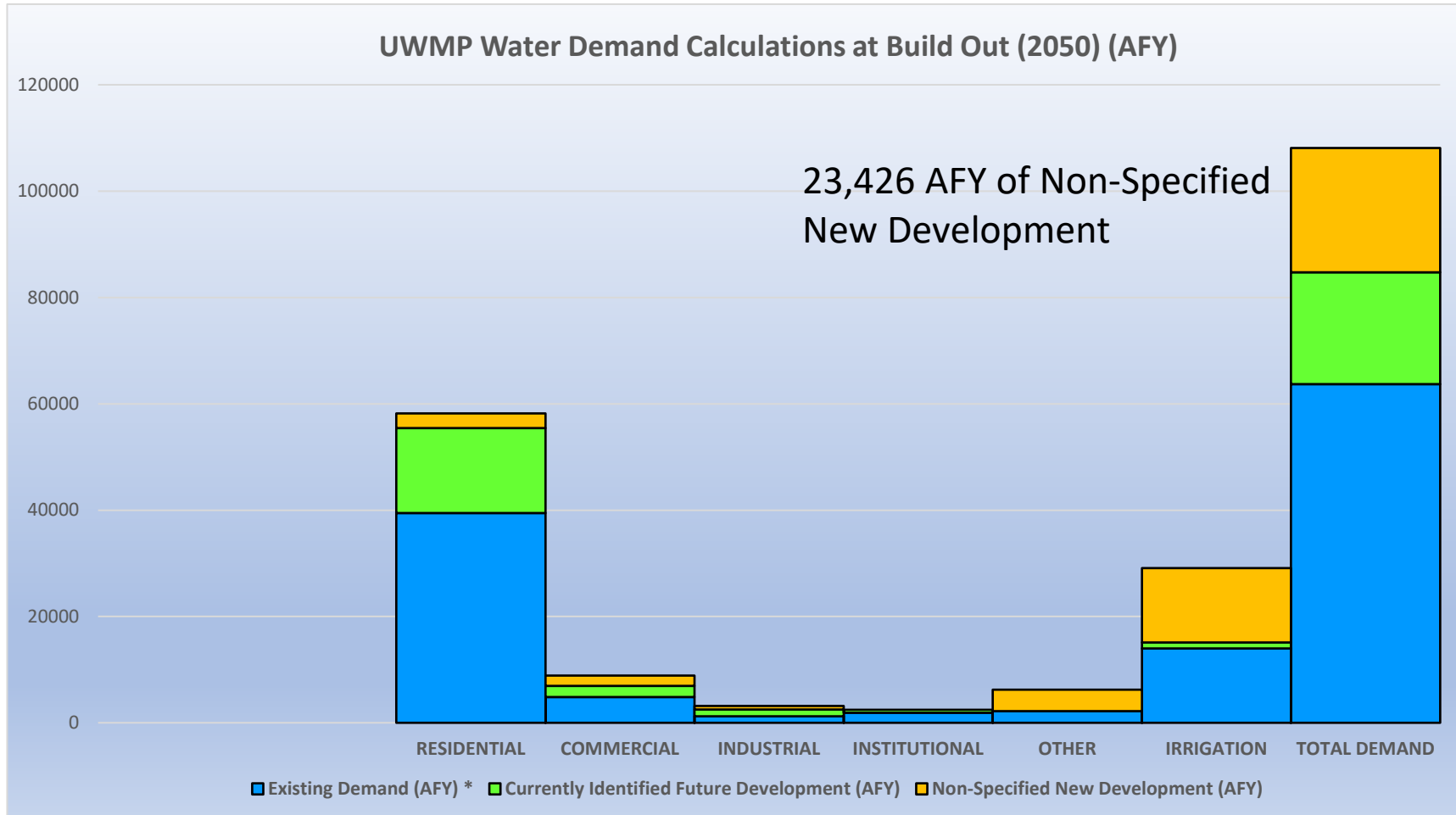

Water Supply Approach

- Project's WSA relies on current and future SCVWA water supply portfolio
- The WSA references the supply portfolio as described in the 2020 UWMP with modifications due to:
 - DWR's December 2021 Draft Delivery Capability Report
 - Modified schedules for the recovery of impacted well capacity due to PFAS, VOC and Perchlorate contamination



2021 SWP Delivery Capability Report

- Draft Report Issued December 31, 2021
- Uses Updated Model (CALSIM3) with longer hydrologic record
- Draft Report indicated reduction of average reliability from 58% to 56% and single dry-year from 7% to 5%
- Analysis was updated using currently available data
- *Resulted in minor modifications to reliability tables*



Modified Schedule Well Restoration

- Saugus Well 201
 - On-line date deferred from 2022 to 2024
 - Accommodated installation and permitting for additional VOC treatment
 - Saugus Well 205
 - On-line date deferred from 2022 to 2024
 - Currently in design for Perchlorate & VOC treatments
 - PFAS impacted Alluvial Wells
 - Well supply of 15,270 AFY to return by 2025
 - Additional Well supply of 6,420 AFY to return by 2030
- *Resulted in minor modifications to reliability tables*



Current Supply Portfolio

Current Supply	Amount (AFY)
SWP Table A Amount (single dry - normal)	4,760-53,300
Groundwater	
Alluvium	15,000-16,000
Saugus	7,500-15,000
Groundwater Banking Programs	
Semitropic	5,000
Rosedale-Rio Bravo	10,000
Transfers & Exchanges	
AVEK - 2 for 1 Exchange	2,350
UWCD - 2 for 1 Exchange	500
BV-RRB Transfer Agreement	11,000
Yuba Accord Water	1,000
Recycled Water	450



Future & Proposed Supplies

Planned Supplies	Amount (AFY)	Proposed On-Line Date
Future and Recovered Groundwater		
Saugus Wells 201 & 205	5,210	2025
Saugus Wells 3 & 4	8,060	2025
Saugus Wells 5 & 6	6,460	2027
Saugus Wells 7 & 8	6,460	2030
Recovered Alluvial Wells	21,690	2030
Recycled Water		
Phase 2 Projects	2,440	2023
FivePoint Westside Communities	5,174	2021-2043
Banking Programs		
Rosedale-RB Additional Extraction	10,000	2030
Semitropic - NLF	4,950	2035
Nickel Water - NLF	1,607	2035



Groundwater Quality

- Groundwater Quality Issues
 - Restoration of PFAS impacted wells
 - Restoration of perchlorate impacted wells
 - Permitting of additional Saugus wells
- Approach consistent with 2020 UWMP
 - Historical and Current Conditions Assessed
 - Treatment methods and scheduling identified
 - Permitting path documented



Climate Change

- Restructured UWMP Information to provide additional text in main report.
- Water Demand anticipated to increase by 3.77% by 2050 consistent with DWR's SGMA approach.
- Groundwater supplies are based on modeling that incorporated the DWR's same SGMA approach
- SWP Reliability 2019 Delivery Capability Report (DCR)
 - Incorporates a sea level rise of 45 cm



Pending Water Conservation Regulations

- Potential reduction of Indoor water use to 42 gpcd
- Potential regulation to mandate irrigation water efficiency
 - *Irrigation efficiencies gains would offset reduced recycled water availability*



SB 610 Requirement: Assessment of Recent Operations

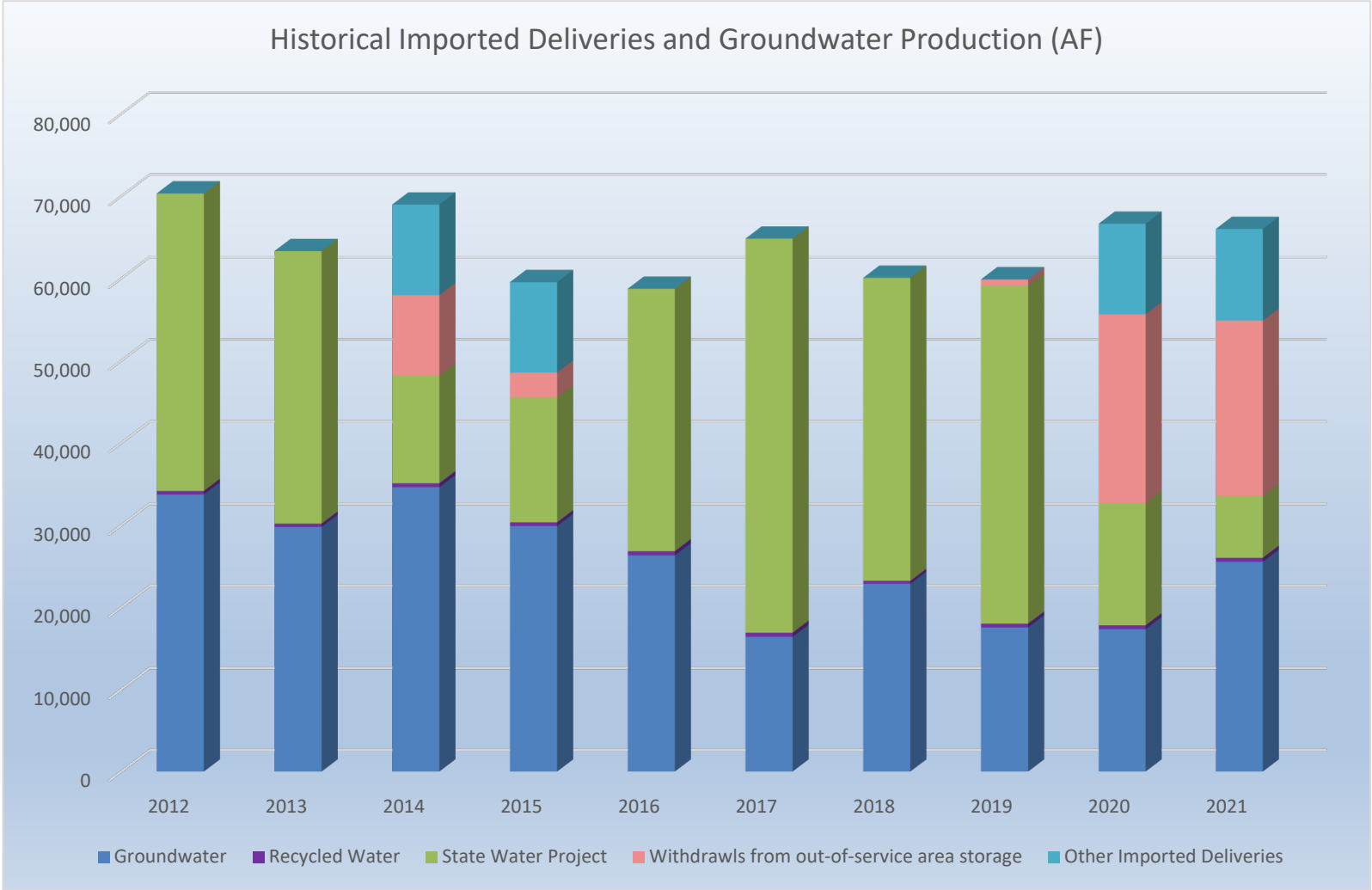

Conclusion: SCV Water demonstrated an ability to conjunctively use its imported surface water and groundwater along with recycled water and conservation to meet water demands facing the dual challenges of severe drought and restricted groundwater supplies.



SB 610 Requirement

Water Balance Analysis Performed for:

- Normal
- Single Dry-Year
- Multiple Dry-Years

Projected Normal Year Supplies and Demands (AF)						
	2025	2030	2035	2040	2045	2050
Existing Supplies						
Existing Groundwater ^(a)						
Alluvial Aquifer ^(o)	8,900	8,180	7,300	7,300	7,300	7,300
Saugus Formation ^(o)	12,940	7,110	7,110	7,110	7,110	7,110
Total Groundwater	21,840	15,290	14,410	14,410	14,410	14,410
Recycled Water ^(b)						
Total Recycled	450	450	450	450	450	450
Imported Water						
State Water Project ^(c)	52,360	51,410	50,460	49,500	49,500	49,500
Flexible Storage Accounts ^(d)						
Buena Vista-Rosedale	11,000	11,000	11,000	11,000	11,000	11,000
Nickel Water - Newhall Land ^(e)	-	-	1,607	1,607	1,607	1,607
Yuba Accord Water ^(f)	1,000	-	-	-	-	-
Total Imported	64,360	62,410	63,067	62,107	62,107	62,107
Existing Banking and Exchange Programs ^(g)						
Rosedale Rio-Bravo Bank ^(g)	-	-	-	-	-	-
Semitropic Bank ^(g)	-	-	-	-	-	-
Semitropic - Newhall Land Bank ^(g)	-	-	-	-	-	-
Antelope Valley West Kern Water Agency Exchange ^(g)	-	-	-	-	-	-
United Water Conservation District Exchange ^(g)	-	-	-	-	-	-
Total Bank/Exchange	0	0	0	0	0	0
Total Existing Supplies	86,650	78,150	77,927	76,967	76,967	76,967
Planned Supplies						
Future and Recovered Groundwater ^(h)						
Alluvial Aquifer ^{(i)(o)}	9,845	19,870	23,490	23,490	23,490	23,490
Saugus Formation ^{(j)(o)}	3,000	2,790	2,790	2,790	2,790	2,790
Total Groundwater	12,845	22,660	26,280	26,280	26,280	26,280
Recycled Water ^(k)						
Total Recycled	1,849	3,696	5,091	6,498	7,499	8,511
Planned Banking Programs						
Rosedale Rio-Bravo Bank ^{(h)(l)}	-	-	-	-	-	-
Total Banking	0	0	0	0	0	0
Total Planned Supplies	14,694	26,356	31,371	32,778	33,779	34,791
Total Supplies (Existing and Planned)^(m)	101,344	104,506	109,298	109,745	110,746	111,758
Demands⁽ⁿ⁾						
Demands with passive conservation ⁽ⁿ⁾	82,100	89,300	97,600	104,300	109,600	115,100
Demands with passive and active conservation ⁽ⁿ⁾	76,400	81,700	88,700	93,600	97,500	101,000



SB 610 Requirement: Supply exceeds Demand

SUPPLY AND DEMAND COMPARISON with the Shadowbox Studios Project									
Year	Normal Year Supply (AF)	Normal Year Demand (AF) with Project	Remaining Balance (AF)	Single-Dry Year Supply (AF)	Single-Dry Year Demand (AF) with Project	Remaining Balance (AF)	5-Year Dry Period Supply (AF)	5-Year Dry Period Demand (AF) with Project	Remaining Balance (AF)
2025	101,344	76,400	24,944	88,689	81,000	7,689	105,643	77,830	27,813
2030	104,506	81,700	22,806	106,736	86,600	20,136	114,033	83,620	30,413
2035	109,298	88,700	20,598	117,428	94,000	23,428	125,555	90,570	34,985
2040	109,745	93,600	16,145	118,835	99,200	19,635	130,089	95,780	34,309
2045	110,746	97,500	13,246	119,836	103,400	16,436	131,020	99,670	31,350
2050	111,758	101,000	10,758	120,848	107,100	13,748	128,720	102,870	25,850

Conclusion: Water Supply is sufficient to meet projected demands in normal, multi dry-years and single dry-years throughout the study period



Conclusion:

- Staff has evaluated the long-term water demands and has compared these needs against existing and planned water supplies.
- Demand projections were based on:
 - Population projections
 - County and City land use plans
 - Both active and passive conservation
 - Climate change impacts
- The WSA concluded that the total projected water supplies over the 30-year projection period will be sufficient to meet the projected demands associated with the proposed Shadowbox Studios Development as well as existing and planned future uses.



Recommendation

That the Water Resources and Watershed Committee recommend that the Board of Directors of the Santa Clarita Valley Water Agency adopt a resolution approving the SB 610 Water Supply Assessment for the Shadowbox Studios Development and direct staff to submit the WSA to the City of Santa Clarita.





SCV
WATER

Questions?



[This page intentionally left blank.]



COMMITTEE MEMORANDUM

DATE: September 14, 2022

TO: Water Resources and Watershed Committee

FROM: Matthew S. Dickens, MPA *MSD*
Sustainability Manager

SUBJECT: Recommend Authorizing the General Manager to Execute a Construction Contract for Bridgeport Pocket Park

SUMMARY

Consistent with the 2019 SCV Water Strategic Plan and in support of the Agency's water conservation engagement, education, and programmatic efforts, staff have developed plans for a water efficient demonstration garden at Bridgeport Pocket Park. Following the Request for Proposal (RFP) process, staff received four (4) proposals for park construction and staff have recognized the lowest-cost bid. Based on these findings, staff recommends that the Water Resource and Watershed Committee recommend that the SCV Water Board of Directors authorize the General Manger to execute a construction contract for the Bridgeport Pocket Park.

DISCUSSION

Following the launch of SCV Water, the Agency directed conservation staff to evaluate refurbishment of the Conservatory Garden and determine ways and means to enhance all landscape assets to improve public awareness, education, and engagement in various conservation programs. With this guidance, conservation staff led a cross-organizational effort to better understand the Agency's landscape assets, conservation program needs, and potential collaborative partnerships. The three-pronged strategy included the transformation of the Conservatory Garden at Rio Vista to enhance the education experience, building "pocket parks" throughout the community to demonstrate smart landscape design and irrigation practices, and to partner with other local agencies to incorporate such facilities in high-traffic areas to increase public consumption. In 2019, after a review of available locations, SCV Water and the City of Santa Clarita (City) entered a Memorandum of Understanding (MOU) to, among other items, construct a demonstration garden at Bridgeport Park. Bridgeport Pocket Park (BPP) would utilize an area within the larger park where the City had turned off irrigation during the 2011-2017 drought. BPP is located at 23521 Bridgeport Lane and is ~16,200 square feet. A picture of the BPP location is provided on the following page (see Figure 1).



Figure 1. Bridgeport Pocket Park Location

During the design phase, the design team incorporated a collaborative process that included SCV Water staff (Conservation, Engineering, GIS), City staff, local landscape designers, an engineering firm, and an irrigation system consultant. The goal of the collaborative design process was to provide visitors with a range of landscape designs, sustainability features (rain gardens, mulching), plant pallets (California natives, low water-using plants), and high-efficiency irrigation (HE nozzles, drip irrigation) technologies that are commonly available to residents in the valley. Additionally, BPP will include site and plant signage, an information kiosk, walking paths, park benches, and a permeable concrete pad for maintenance vehicles and to support additional programming capabilities (EV, Tiny Home, Vendors). The design process was completed in 2021 and the BPP plans are included as an attachment.

In August 2022, the Conservation Team, with support from Engineering, submitted the completed design plan for RFP using PlanetBids. On September 2, 2022, SCV Water received proposals from four (4) firms for BPP construction. The following table notes the firms that responded to the RFP and their cost proposals respectively.

Table 1. SCV Water – Bridgeport Pocket Park Construction RFP Responses

Firm	C.S. Legacy Construction, Inc.	United Construction & Landscape, Inc.	R.C. Beker and Son, Inc.	Marina Landscape, Inc.
Cost Proposal	\$373,147.60	\$389,428.36	\$390,111.97	\$426,395.00
Cost per SF	\$23.32	\$24.34	\$24.38	\$26.65

FINANCIAL CONSIDERATIONS

BPP funding for Fiscal Year 2022/2023 was estimated at \$230,000. The lowest bid for BPP construction is \$373,147.60, which is \$143,147.60 above the current budgeted amount. Expenses beyond the budgeted amount will require a transfer of available funds from another project. Budget from the Conservatory Garden and Education Experience for FY 2022/2023 would be available for the BPP.

STATEGIC PLAN OBJECTIVE(S)

Goal A. Customer/Community: Implement policies supporting social, quality of life, and environmental values of the community.

Strategy A.2 Proactively communicate with and engage our community on water matters of importance to the region positioning SCV Water as a leading resource and reliable authority on water issues.

A.2.6 Raise awareness of and demand for conservation programs (e.g. water conservation campaign(s) and related media buys, public and school education programs, participation at public events, SCV Water website, e-newsletter and social media, self-guided landscape tour, conservatory garden, etc.)

Goal C. Water Supply and Resource Sustainability: Implement programs to ensure the service area has reliable and sustainable supplies of water.

Strategy C.4 Advance demand management and achieve State mandated water use efficiency targets.

C.4.9 Promote drought tolerant and water efficient landscapes out into the community

C.4.10 Communicate with customers the message that “conservation is a way of life”

CEQA CONSIDERATION

The Project, aka the whole of the action, qualifies for an exemption under CEQA Guidelines Section 15301 (c) Class 1 - Existing Facilities because it is a minor alteration of an existing public facility as it concerns the modification of an existing sidewalk and bicycle path involving negligible or no expansion of use. The project also qualifies for an exemption under Section 13504(b) Class 4 - Minor Alterations to Land as the Project consists of new landscaping which is replacing existing conventional landscape with water efficient landscape.

RECOMMENDATION

That the Water Resources and Watershed Committee recommends that the Board of Directors authorize the General Manager to execute a construction contract for Bridgeport Pocket Park.

Attachment

SANTA CLARITA VALLEY WATER AGENCY LOS ANGELES COUNTY, CALIFORNIA BRIDGEPORT POCKET PARK

PROJECT NO. 200701
August 2020

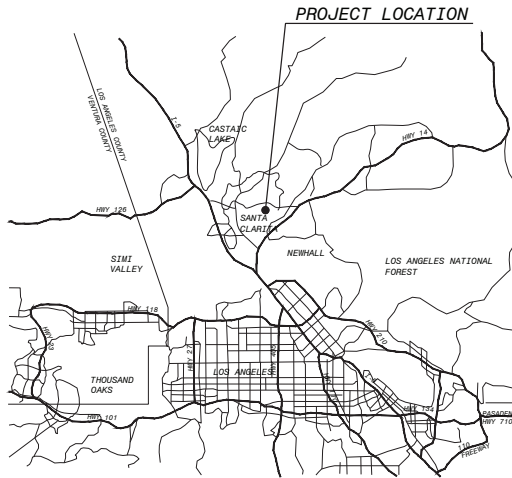

VICINITY MAP
SCALE: 1" = 20 MILES

SH	DWG	DESCRIPTION
1	G-01	TITLE SHEET, SHEET INDEX, VICINITY MAP AND LOCATION MAP
2	C-01	EXISTING SITE PLAN
3	C-02	GARDEN AREA PLAN
4	C-03	LANDSCAPE PLAN, GARDEN AREA No. 1
5	C-04	LANDSCAPE PLAN, GARDEN AREA No. 2
6	C-05	LANDSCAPE PLAN, GARDEN AREA No. 3
7	C-06	LANDSCAPE PLAN, GARDEN AREA No. 4
8	LI-1	IRRIGATION SCHEDULE AND NOTES
9	LI-2	IRRIGATION PLAN
10	LI-3	IRRIGATION DETAILS
11	LI-4	IRRIGATION SPECIFICATIONS

DIAL TOLL FREE
1-800-422-4133
AT LEAST TWO DAYS
BEFORE YOU DIG

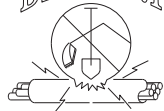

UNDERGROUND SERVICE ALERT(USA) OF SOUTHERN CALIFORNIA



LOCATION MAP
NOT TO SCALE

REVIEWED BY	APPROVED FOR CONSTRUCTION
DATE	DATE
	DIRECTOR OF PUBLIC WORKS CITY OF SANTA CLARITA

REVISIONS			
NO.	DESCRIPTION	DATE	BY



SANTA CLARITA VALLEY WATER AGENCY
WATER RESOURCES SECTION
26501 SUMMIT CIRCLE
SANTA CLARITA, CA. 91350
(661) 297-1600

BRIDGEPORT POCKET PARK
TITLE SHEET, SHEET INDEX,
VICINITY MAP AND LOCATION MAP

DATE: AUGUST 2020
PROJECT NO: 200701
SHEET: G-01
1 OF 11

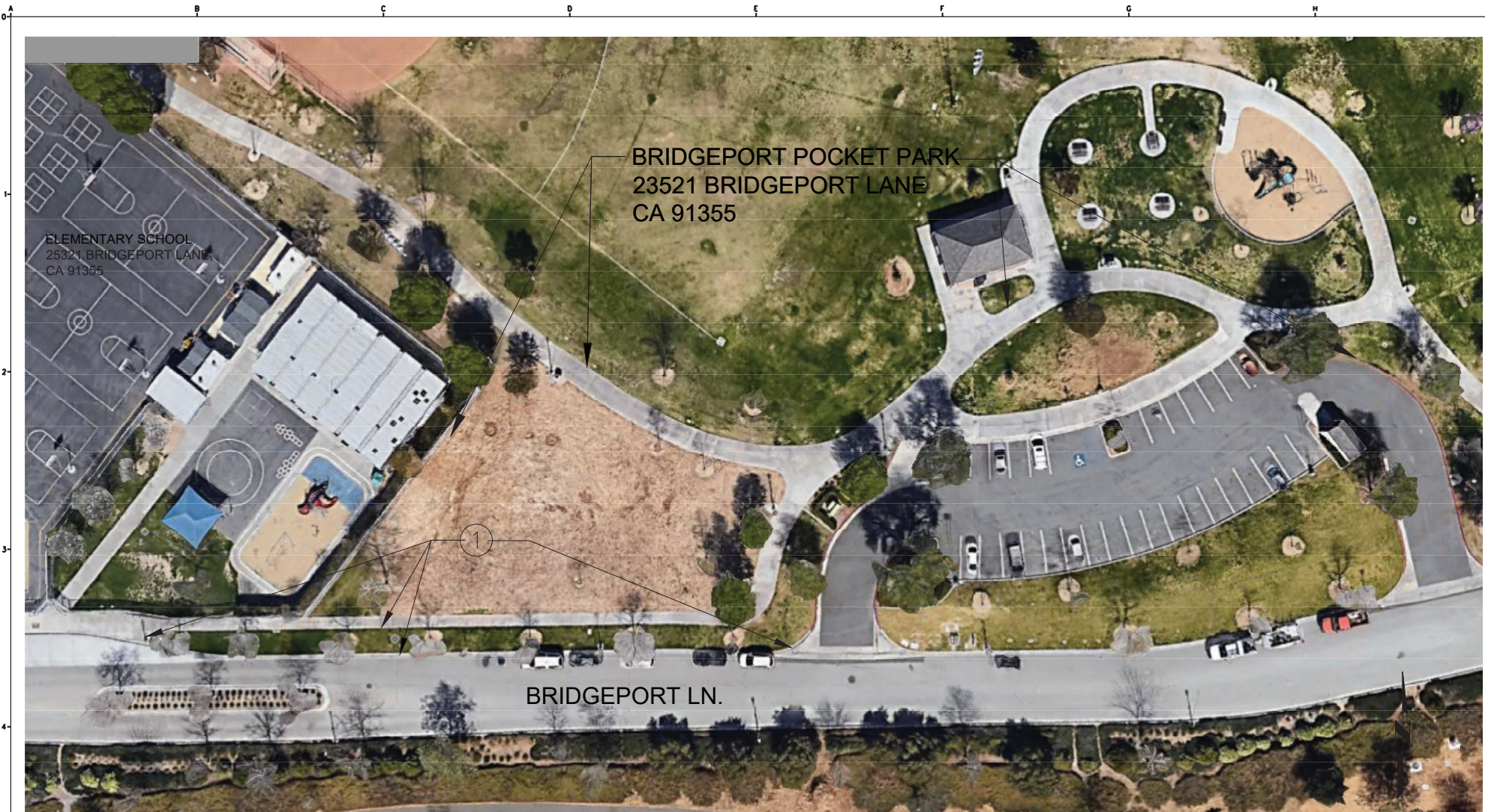

ELEMENTARY SCHOOL
25321 BRIDGEPORT LANE,
CA 91365

BRIDGEPORT POCKET PARK
23521 BRIDGEPORT LANE
CA 91355

BRIDGEPORT LN.

CONSTRUCTION NOTES:

1. REMOVE EXIST. GRASS AND INSTALL KURAPIA (12-18" PLUGS), PER SPECIFICATION SECTION xxxxx

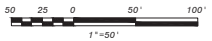

REVISIONS			
NO.	DESCRIPTION	DATE	BY

SCALES
OF
DIM
IF THIS BAR IS NOT
DIMENSION SHOWN,
ADJUST SCALES
ACCORDINGLY.



SANTA CLARITA VALLEY WATER AGENCY
WATER RESOURCES SECTION
26501 SUMMIT CIRCLE
SANTA CLARITA, CA, 91350
(661) 297-1600

BRIDGEPORT POCKET PARK

EXISTING SITE PLAN

DATE: AUGUST 2020
PROJECT NO: 200701
SHEET: C-01
2 OF 11

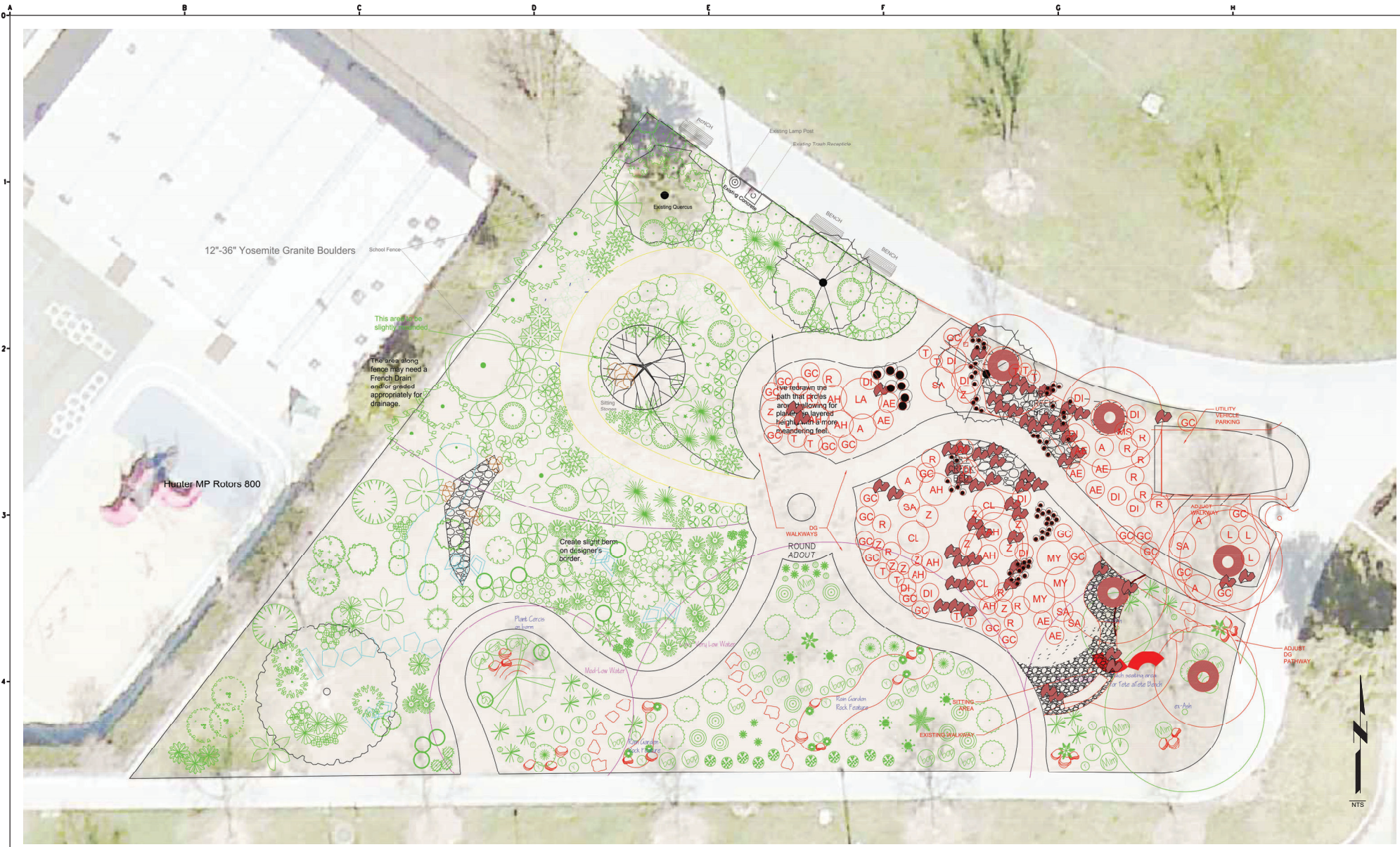

REVISIONS			
NO.	DESCRIPTION	DATE	BY

SCALES	



SANTA CLARITA VALLEY WATER AGENCY
WATER RESOURCES SECTION
 26501 SUMMIT CIRCLE
 SANTA CLARITA, CA, 91350
 (661) 297-1600

BRIDGEPORT POCKET PARK
GARDEN AREA PLAN

DATE:	AUGUST 2020
PROJECT NO.:	200701
SHEET:	C-02
	3 OF 11

A B C D E F G H

GARDEN NO. 1



12"-36" Yosemite Granite Boulders



Classic Park Benches



Hunter MP Rotors 800

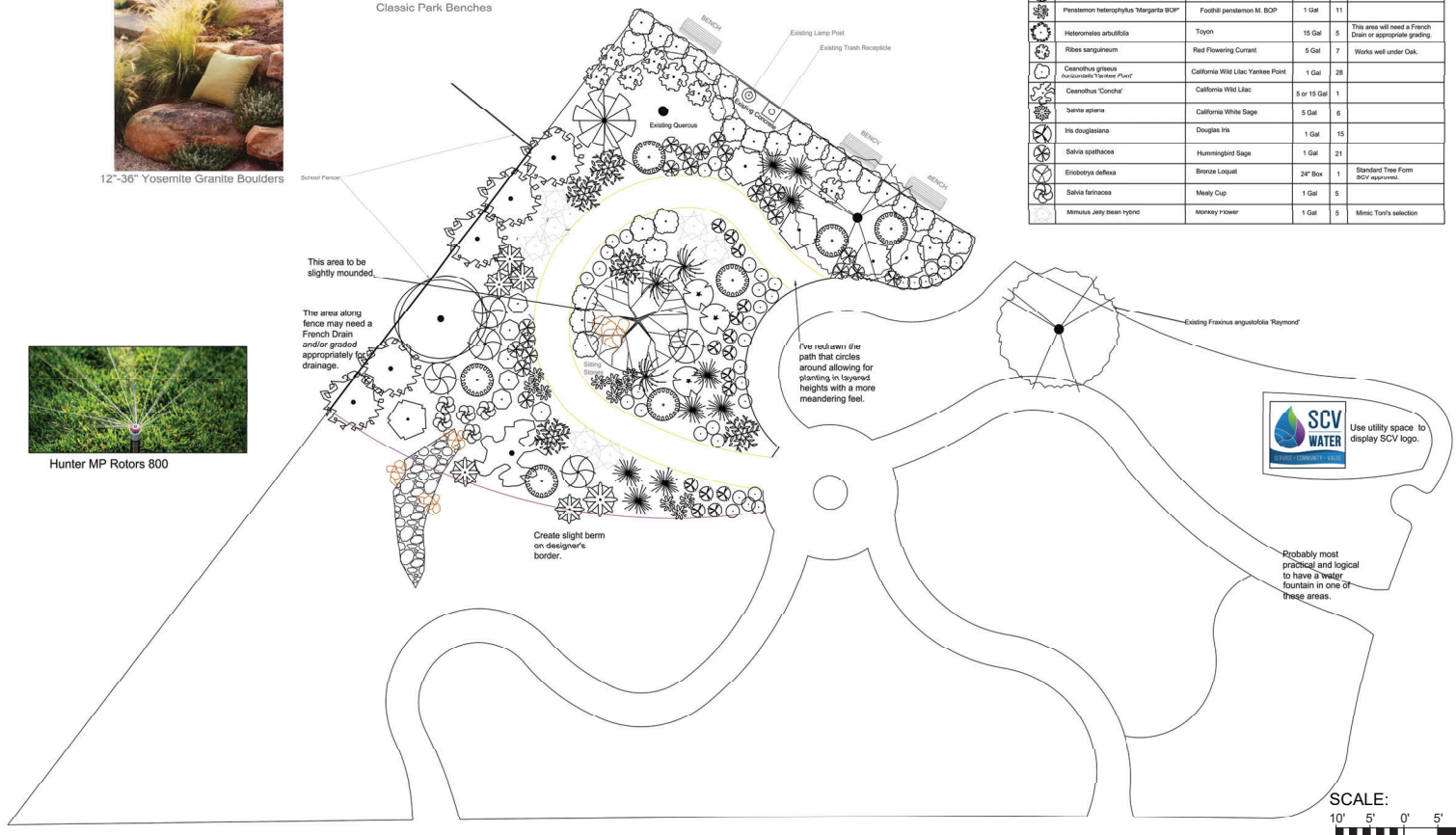

PLANT LEGEND				
BOTANICAL NAME	COMMON NAME	SIZE	QTY	NOTES
<i>Calyochus hartwegii</i>	Sundrops	1 Gal	28	Low growing border plants
<i>Dendromecon</i>	Bush Poppy	15 Gal	1	Low growing border plants
<i>Rhus ovata</i>	Sugarbush	15 Gal	1	Western native
<i>Verbena lasina</i>	Cicilia Island Verbena	1 Gal	8	
<i>Gelsecia speciosa</i>	Island Snapdragon	5 Gal	5	
<i>Trichostema lanatum</i>	Blue Whorly Curls	5 Gal	3	Needs Excellent drainage
<i>Muhlenbergia rigens</i>	Deer Grass	5 Gal	9	Free soil drainage hole with gravel base
<i>Zauschneria californica</i>	California Fuchsia	5 Gal	4	
<i>Encelia californica</i>	Coast Sunflower	5 Gal	9	
<i>Salvia clevelandii</i>	California Blue Sage	5 Gal	4	
<i>Hesperaloe parviflora</i>	Red Yucca	5 Gal	3	
<i>Parkinsonia 'Desert Museum'</i>	Palo Verde Desert Museum	24" Box	1	
<i>Penstemon heterophyllus 'Margaret BOP'</i>	Footfall penstemon M. BOP	1 Gal	11	
<i>Heteromeles arbutifolia</i>	Toyon	15 Gal	5	This area will need a French Drain or appropriate grading
<i>Ribes sanguineum</i>	Red Flowering Currant	5 Gal	7	Works well under Oak.
<i>Caesalpinia grievea 'Yankee Point'</i>	California Wild Lilac Yankee Point	1 Gal	28	
<i>Caesalpinia 'Concho'</i>	California Wild Lilac	5 or 15 Gal	1	
<i>Salvia spina</i>	California White Sage	5 Gal	6	
<i>Hic douglasiana</i>	Douglas Iris	1 Gal	15	
<i>Salvia spathulata</i>	Hummingbird Sage	1 Gal	21	
<i>Eriobotrya deflexa</i>	Stones Loquat	24" Box	1	Standard Tree Form SCV approved
<i>Salvia farinacea</i>	Mealy Cup	1 Gal	5	
<i>Mimulus jolly brain hybrid</i>	Monkey Flower	1 Gal	5	Mimic Toni's selection

REVISIONS	BY
December 10, 2019 - Draft	MSJ
January 16, 2020	MLI

SCV
Bridgeport Pocket Park
Santa Clarita, CA

Songbird Garden Design
 Mary Elizabeth - Landscape Designer
 Newhall, CA
 Tel: 818-854-5562

NORTH



Probably most practical and logical to have a water fountain in one of these areas.



REVISIONS			
NO.	DESCRIPTION	DATE	BY

SCALES

 IF THIS BAR IS NOT DIMENSION SHOWN, ADJUST SCALES ACCORDINGLY.



SANTA CLARITA VALLEY WATER AGENCY
WATER RESOURCES SECTION
 26501 SUMMIT CIRCLE
 SANTA CLARITA, CA. 91350
 (661) 297-1600

BRIDGEPORT POCKET PARK
LANDSCAPE PLAN
GARDEN AREA No. 1

DATE: **AUGUST 2020**
 PROJECT NO: **200701**
 SHEET: **C-03**
 4 OF 11

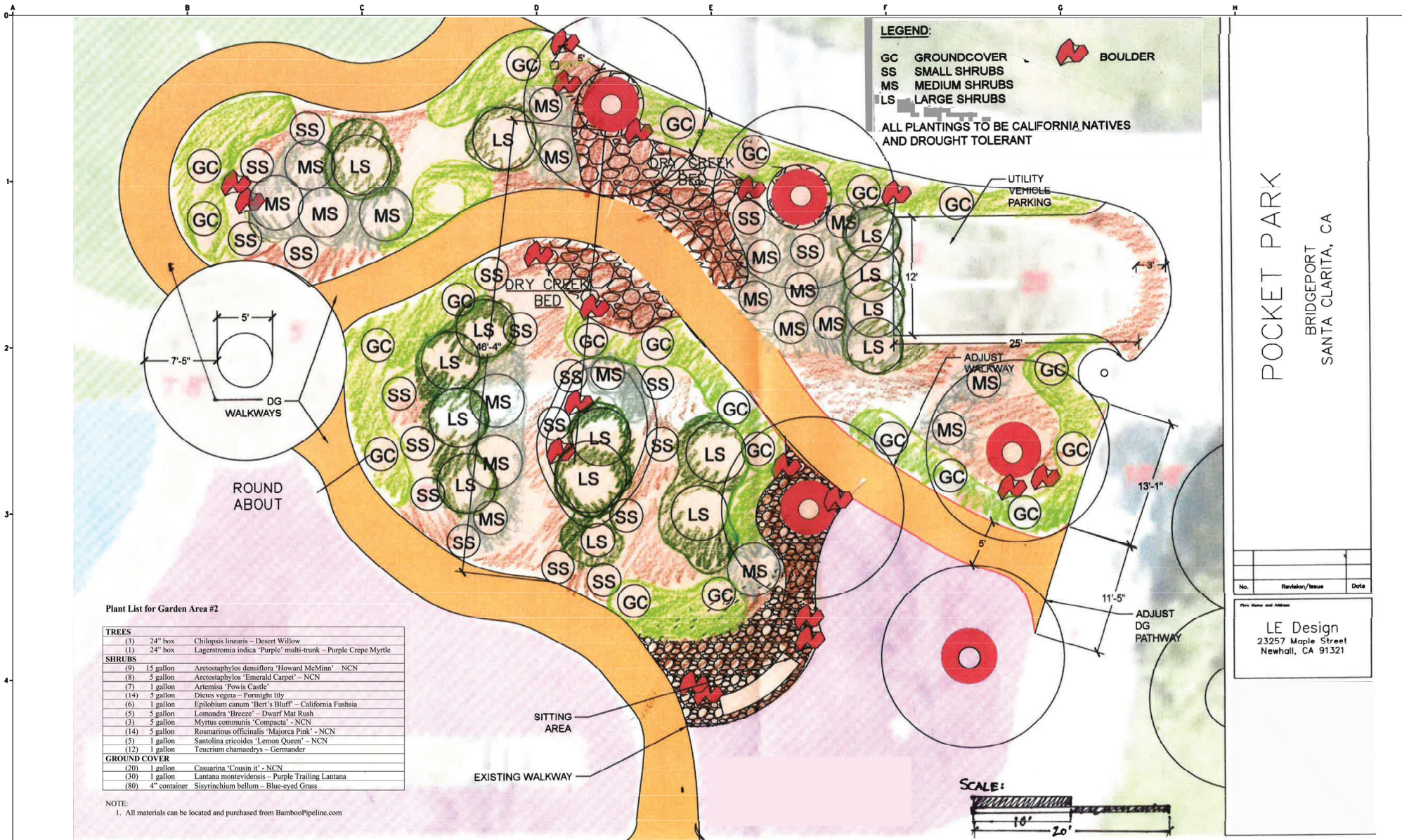

Plant List for Garden Area #2

TREES		
(3)	24" box	Chilopsis linearis - Desert Willow
(1)	24" box	Lagerstromia indica 'Purple' multi-trunk - Purple Crepe Myrtle
SHRUBS		
(9)	15 gallon	Arcostaphylos densiflora 'Howard McMin' - NCN
(8)	5 gallon	Arcostaphylos 'Emerald Carpet' - NCN
(7)	1 gallon	Artemisia 'Powis Castle'
(14)	5 gallon	Dietsa vegeta - Fournight Lily
(6)	1 gallon	Epilobium canum 'Bert's Bluff' - California Fuchsia
(5)	5 gallon	Lomandra 'Breeze' - Dwarf Mat Rush
(3)	5 gallon	Myrtus communis 'Compacta' - NCN
(14)	5 gallon	Roxanthis officinalis 'Majorca Pink' - NCN
(5)	1 gallon	Santolina ericoides 'Lemon Queen' - NCN
(12)	1 gallon	Teucrium chamaedrys - Germander
GROUND COVER		
(20)	1 gallon	Casuarina 'Cousin it' - NCN
(20)	1 gallon	Lantana montevidensis - Purple Trailing Lantana
(80)	4" container	Sisyrinchium bellum - Blue-eyed Grass

NOTE:
1. All materials can be located and purchased from BambooPipeline.com

POCKET PARK
BRIDGEPORT
SANTA CLARITA, CA

No.	Revision/Issue	Date

Plan Name and Address

LE Design
23257 Maple Street
Newhall, CA 91321

REVISIONS			
NO.	DESCRIPTION	DATE	BY



SANTA CLARITA VALLEY WATER AGENCY
WATER RESOURCES SECTION
26501 SUMMIT CIRCLE
SANTA CLARITA, CA. 91350
(661) 297-1600

BRIDGEPORT POCKET PARK
LANDSCAPE PLAN
GARDEN AREA No. 2

DATE	AUGUST 2020
PROJECT NO.	200701
SHEET	C-04
	5 OF 11



TETE A TETE BENCH DETAIL
NTS

The Grass Is Always Greener Designs
25359 Via Tello
Valencia, CA 91355
Julie Molinare
661-917-3921
julie@thegrassisalwaysgreener.net

Bridgeport Pocket Park
Plant List - Garden #4

Qty	Name	Size	Nursery	Misc.
TREES:				
1	Canis aculeatus - Wild Black Dog (Western Redbud)	24" Pin 19' cal	Alto Nursery	From Plant Yard
SHRUBS/PERENNIALS:				
2	Ardisia coccinea - Ardisia 'Red Pin' & Ardisia coccinea 'Parula'	1' cal	Worldwide Exotics	
3	Alca 'Coral Gold' - Coral Gold Rose	9' cal	ET or Sam Morgan	
4	Alca 'Coral Gold' - Coral Gold Rose	9' cal	WWE or Sam Morgan	
5	Alca 'Coral Gold' - Coral Gold Rose	9' cal	ET or Green Thumb Yard	
6	Alca 'Coral Gold' - Coral Gold Rose	9' cal	Worldwide Exotics	
7	Alca 'Coral Gold' - Coral Gold Rose	9' cal	Worldwide Exotics	
8	Alca 'Coral Gold' - Coral Gold Rose	9' cal	Worldwide Exotics	
9	Alca 'Coral Gold' - Coral Gold Rose	9' cal	Worldwide Exotics	
10	Alca 'Coral Gold' - Coral Gold Rose	9' cal	Worldwide Exotics	
11	Alca 'Coral Gold' - Coral Gold Rose	9' cal	Worldwide Exotics	
12	Alca 'Coral Gold' - Coral Gold Rose	9' cal	Worldwide Exotics	
13	Alca 'Coral Gold' - Coral Gold Rose	9' cal	Worldwide Exotics	
14	Alca 'Coral Gold' - Coral Gold Rose	9' cal	Worldwide Exotics	
15	Alca 'Coral Gold' - Coral Gold Rose	9' cal	Worldwide Exotics	
16	Alca 'Coral Gold' - Coral Gold Rose	9' cal	Worldwide Exotics	
17	Alca 'Coral Gold' - Coral Gold Rose	9' cal	Worldwide Exotics	
18	Alca 'Coral Gold' - Coral Gold Rose	9' cal	Worldwide Exotics	
19	Alca 'Coral Gold' - Coral Gold Rose	9' cal	Worldwide Exotics	
20	Alca 'Coral Gold' - Coral Gold Rose	9' cal	Worldwide Exotics	
GRASSES/GRASS-LIKE PLANTS:				
11	Phalaris amabilis and/or P. amabilis 'Wild Arbutus' - Phalaris Amabilis Wild Dog	9' cal	Green Thumb Yard	
12	Carex verticillata - Funtia Rose	1' cal	Green Thumb Yard	
13	Muhlenbergia capensis - Pink Muhly Grass	9' cal	Green Thumb Yard	

REVISIONS	BY
1/12/20	jsm

The Grass Is Always Greener Designs
Julie S. Molinare
25359 Via Tello
Valencia, CA 91355
julie@thegrassisalwaysgreener.net

Bridgeport Pocket Parks
Garden #4

PLANTING PLAN

Drawn by
jsm
Checked by
jsm
Date
12/12/19

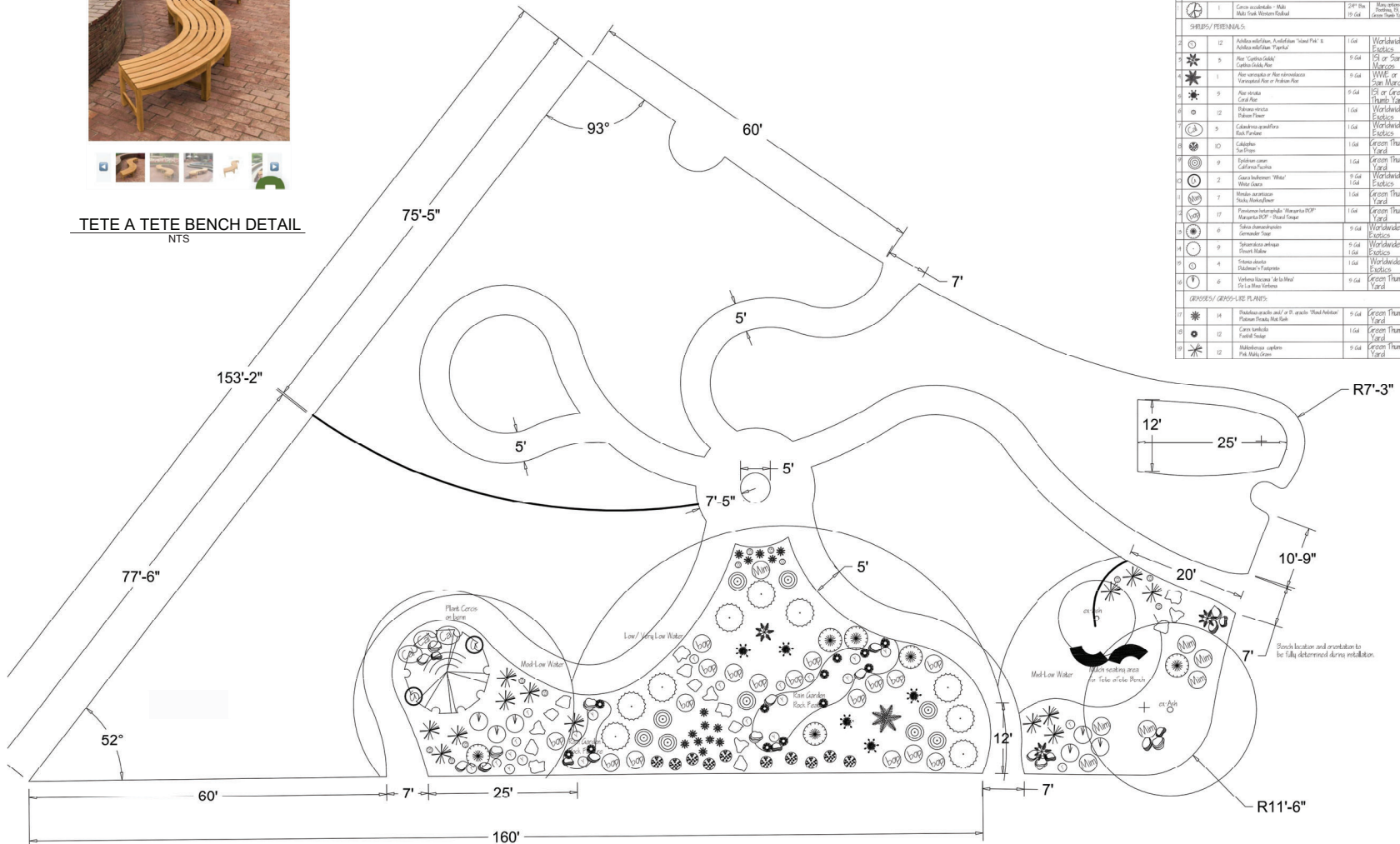

REVISIONS			
NO.	DESCRIPTION	DATE	BY



SANTA CLARITA VALLEY WATER AGENCY
WATER RESOURCES SECTION
26501 SUMMIT CIRCLE
SANTA CLARITA, CA. 91350
(661) 297-1600

BRIDGEPORT POCKET PARK
LANDSCAPE PLAN
GARDEN AREA No. 4

DATE	AUGUST 2020
PROJECT NO.	200701
SHEET	C-06 7 OF 11

IRRIGATION NOTES

- ALL BASE INFORMATION HAS BEEN TAKEN FROM DRAWINGS PROVIDED BY OAKRIDGE LANDSCAPE AND AS-BUILT DRAWINGS OF THE EXISTING PARK IRRIGATION DRAWINGS.
 - REFER TO PROJECT SPECIFICATIONS FOR INSTALLATION AND MATERIAL REQUIREMENTS AND METHODOLOGY.
 - CONTRACTOR SHALL FIELD VERIFY PRESSURE AT POINT-OF-CONNECTION LOCATIONS FOR EACH TAP PRIOR TO ORDERING MATERIALS OR STARTING ANY IRRIGATION INSTALLATION AND NOTIFY CONSULTANT OF ANY DIFFERENCE OF 10 PSI.
 - SYSTEM HAS BEEN DESIGNED BASED ON THE STATIC WATER PRESSURE NOTED ON THE PLANS. IF CONTRACTOR FAILS TO NOTIFY CONSULTANT OF THE STATIC PSI DIFFERENCE, HE ASSUMES FULL RESPONSIBILITY FOR ANY SYSTEM ALTERATIONS AS DIRECTED BY THE CONSULTANT.
- | POC #15 | PSI | GPM | METER SIZE | TOTAL LANDSCAPED AREA |
|---------|-----|-----|------------|-----------------------------|
| | 100 | xx | 3" | (existing irrigated area) |
| | | | | (demonstration garden only) |
- CONTRACTOR TO FIELD VERIFY SIZE, LOCATION AND QUANTITY OF EXISTING STREET SLEEVES INSTALLED UNDER STREET IMPROVEMENT PACKAGE PRIOR TO INSTALLATION OF IRRIGATION SYSTEM, AND NOTIFY CONSULTANT OF ANY DIFFERENCES.
 - INSTALL IRRIGATION SLEEVES UNDER ALL SIDEWALKS PER THE FOLLOWING SCHEDULE:

PIPE SIZE OR WIRE QUANTITY	REQUIRED SLEEVES
WIRE SLEEVES	1/2" SDR 35 PVC
PIPE SLEEVES	1/2" SDR 35 PVC

 ALL OTHER SLEEVE SIZES SHALL BE 2X LARGER THAN PIPE AND SHALL BE SCH 40 PVC.
 - LATERAL PIPING SHALL BE INSTALLED 12" BELOW GRADE USING SCH 40 BE PIPE.
 - UTILIZE EXISTING VALVE LOCATIONS FOR THE NEW VALVES INDICATED. EXISTING VALVES LOCATION ARE APPROXIMATE AND ARE BASED ON THE LOCATIONS INDICATED ON THE AS-BUILT DRAWINGS. UTILIZE EXISTING VALVE WIRING AT EACH OF THESE LOCATIONS.

IRRIGATION SCHEDULE

SYMBOL	MANUFACTURER	MODEL NUMBER	DESCRIPTION	DETAIL No.	PSI	GPM	RADIUS	PRECIP.
	HUNTER HUNTER	MP3000 90" NOZ. PROS-12-PR530-CV	MP ROTATOR NOZZLES ON 12" PRES. REG. POP-UP BODY	4 LI-5.01	40	0.86, 1.93	22-30" Per Spacing	0.43" / hr
	HUNTER HUNTER	MP800 360" NOZ. PROS-12-PR530-CV	MP ROTATOR NOZZLES ON 6" PRES. REG. POP-UP BODY	4 LI-5.01	40	0.23, 0.42	6-10" Per Spacing	0.83" / hr
	HUNTER HUNTER	MP3000 90" NOZ. PROS-12-PR540-CV	MP ROTATOR NOZZLES ON 12" PRES. REG. POP-UP BODY	4 LI-5.01	40	0.86, 1.93	22-30" Per Spacing	0.43" / hr
	HUNTER HUNTER	MP800 360" NOZ. PROS-12-PR540-CV	MP ROTATOR NOZZLES ON 6" PRES. REG. POP-UP BODY	4 LI-5.01	40	0.23, 0.42	6-10" Per Spacing	0.83" / hr
	HUNTER HUNTER	MP3000 90" NOZ. PROS-12-CV	MP ROTATOR NOZZLES ON 12" PRES. REG. POP-UP BODY	4 LI-5.01	40	0.86, 1.93	22-30" Per Spacing	0.43" / hr
	HUNTER HUNTER	MP800 360" NOZ. PROS-12-CV	MP ROTATOR NOZZLES ON 6" PRES. REG. POP-UP BODY	4 LI-5.01	40	0.23, 0.42	6-10" Per Spacing	0.83" / hr
	HUNTER	RZWS-18-25	ROOT ZONE WATERING SYSTEM TWO (2) PER TREE	8 ON SHIT. LI-6.01	30	0.25 EA.	0'	(TWO PER TREE)
	APPROVED	SCH 40 BE - ALL 3/4"	PVC PURPLE TREE LATERAL PIPING TO SUPPLEMENTARY TREE IRRIGATION HEADS	1 - LI-5.01 8 - LI-5.03				
	RAINBIRD	XFS-06-18-XX	IN LINE EMITTER TUBING 18" O.C. EMITTERS 18" O.C. ROW SPACING	5-7 LI-5.01	15	0.6 GPH	0'	0.43
	RAINBIRD	XFF-TEE, XFF-ELBOW	SURFACE MOUNTED ELL, TEE OR CROSS CONNECTION	5-7 LI-5.01				
	AS DETAILED	AS DETAILED	PVC INTAKE/EXHAUST HEADER W/ XFF-MA-050 ADAPTER FITTINGS	5-7 LI-5.01				
	BUCKNER/SUPERIOR	950 DWB-100	DRIP VALVE ASSEMBLY	3 - LI-5.01				
	BUCKNER/SUPERIOR	950 PRS	CONTROL VALVE SEE PLANS FOR SIZE SET REGULATOR AT 50 PSI	2 - LI-5.01				
	PER DETAIL		DRIP LINE FLUSH VALVE	7 LI-5.02				
	EXISTING	SCH 40 BE/CL 315	PRESSURE SUPPLY PIPING - SPEARS OR EQUAL					NOTE: ALL FITTINGS, NIPPLES AND UNIONS TO BE LANSO OR EQUAL
	APPROVED	SCH 40 BE	PVC LATERAL LINE (SIZE PER PLAN) (SEE NOTE #9) SPEARS OR EQUAL	1 - LI-5.01				
	APPROVED		PVC IRRIGATION SLEEVE FOR BELOW PAVING APPLICATIONS (SEE NOTE #4) SPEARS OR EQUAL	REFER TO NOTES				
	RAINBIRD	AVR950	AIR/VACUUM RELIEF VALVE INSTALL AT HIGHEST POINT	29 LI-5.03				

ALL IRRIGATION CONTROL VALVES SHALL BE LOCATED IN SHRUB AREAS. SETBACK FROM FRONT EDGE OF EACH VALVE BOX IS TO BE A MINIMUM OF 1'-0" FROM THE EDGE OF PAVING OR TURF AREAS WHERE SPACE ALLOWS.

LATERAL PIPE SIZING IS INDICATED BY THE FOLLOWING SYMBOLS:					
3/4" - I	1" - II	1-1/4" - III	1-1/2" - X	2" - V	2-1/2" - VI
ALL BUBBLER SYSTEM PIPING SHALL BE 3/4" UNLESS OTHERWISE NOTED AS 1".					

Aqua Commercial Irrigation
810 Los Vallecitos Blvd., Suite 204
San Marcos, California 92069
Ph: (760)750-1900 Fax: (760)750-1999

- NOTES:**
- Refer to Sheet LI-1 for Irrigation Schedule.
 - Refer to Sheet LI-2 for Irrigation Plans.
 - Refer to Sheet LI-3 for Irrigation Details.
 - Refer to Sheet LI-4 for Irrigation Specifications

REVISIONS				DESIGNED BY:	PLANS PREPARED BY:	DATE:
NO.	DESCRIPTION	DATE	BY			

<p>SCALES</p> <p>1" = 10'-0"</p> <p>IF THIS BAR IS NOT DIMENSION SHOWN, ADJUST SCALES ACCORDINGLY.</p>	<p>OAKRIDGE LANDSCAPE</p>	<p>SANTA CLARITA VALLEY WATER AGENCY WATER RESOURCES SECTION 8000 BURNETT DRIVE SANTA CLARITA, CA. 91350 (661) 259-2737</p>	<p>BRIDGEPORT POCKET PARK</p> <p>IRRIGATION SCHEDULE AND NOTES</p>	<p>DATE: AUGUST 2020</p> <p>PROJECT NO: 200701</p> <p>SHEET: LI-1</p> <p>8 OF 11</p>
--	---------------------------	---	--	--

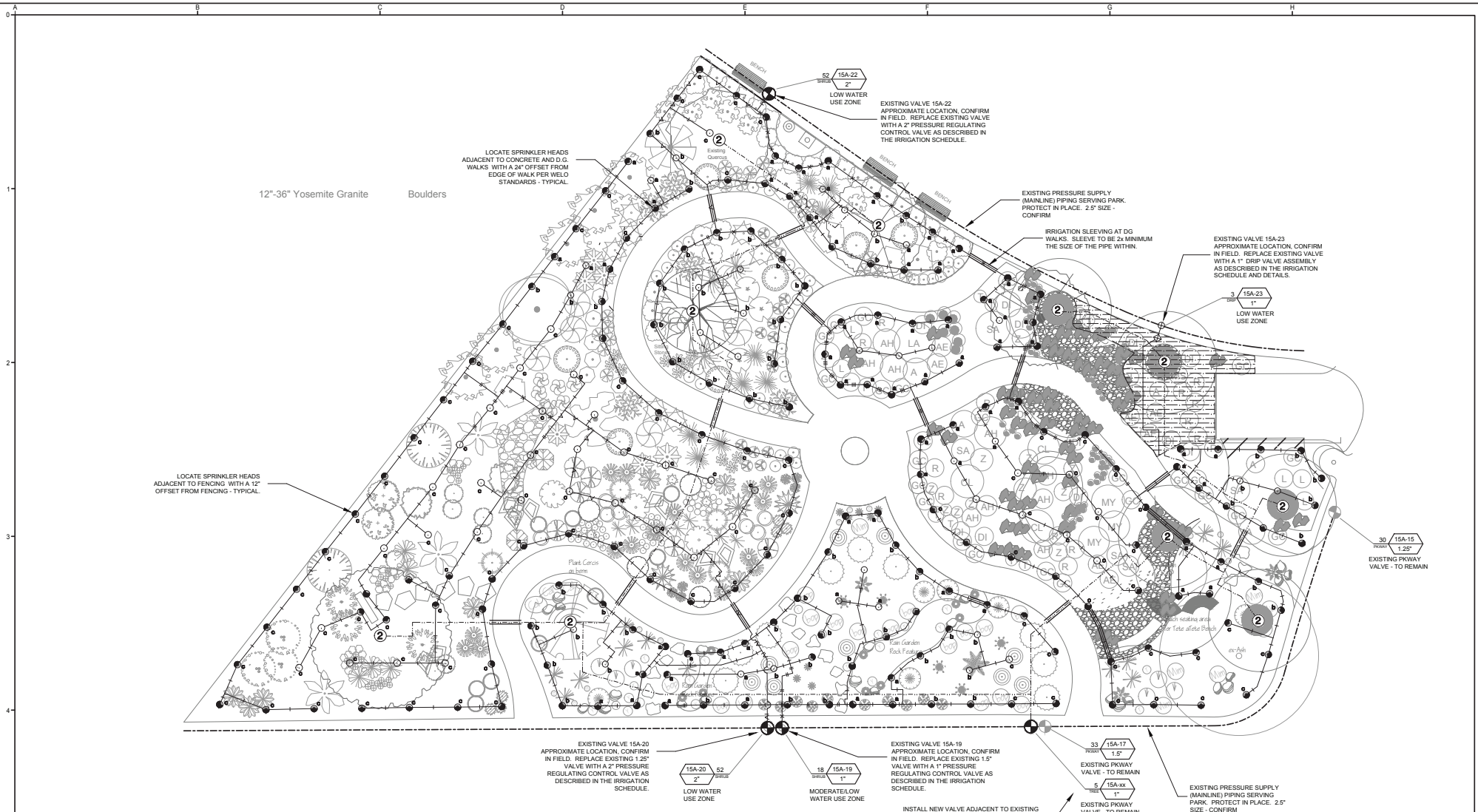

- NOTES:**
1. Refer to Sheet LI - 1 for Irrigation Schedule.
 2. Refer to Sheet LI - 2 for Irrigation Plans.
 3. Refer to Sheet LI - 3 for Irrigation Details.
 4. Refer to Sheet LI - 4 for Irrigation Specifications.

LATERAL PIPE SIZING IS INDICATED BY THE FOLLOWING SYMBOLS:					
3/4" - I	1" - II	1-1/4" - III	1-1/2" - X	2" - V	2-1/2" - VI
ALL BUBBLER SYSTEM PIPING SHALL BE 3/4" UNLESS OTHERWISE NOTED AS 1"					

REVISIONS			
NO.	DESCRIPTION	DATE	BY

DESIGNED BY: **OAKRIDGE LANDSCAPE**

DRAWN BY:

CHECKED BY:

SCV WATER

SANTA CLARITA VALLEY WATER AGENCY

WATER RESOURCES SECTION

1000 W. BURNETT AVENUE

SANTA CLARITA, CA. 91350

(661) 259-2737

BRIDGEPORT POCKET PARK

IRRIGATION PLAN

Aqua Commercial Irrigation

1915 Lee Valley Blvd., Suite 214
 San Marcos, California 92069
 Ph: (760)760-1900 Fax: (760)760-1999

ACI
 Irrigation & Water Management

DATE:	AUGUST 2020
PROJECT NO:	200701
SHEET:	LI-2
	9 OF 11

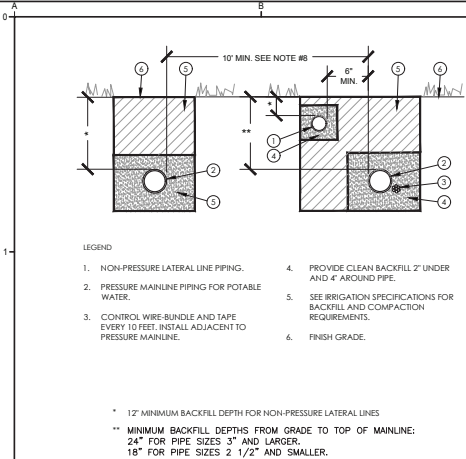

1 TRENCHING
NTS

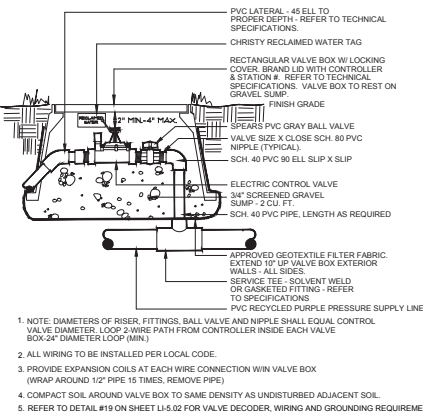

2 ELECTRIC CONTROL VALVE
NTS

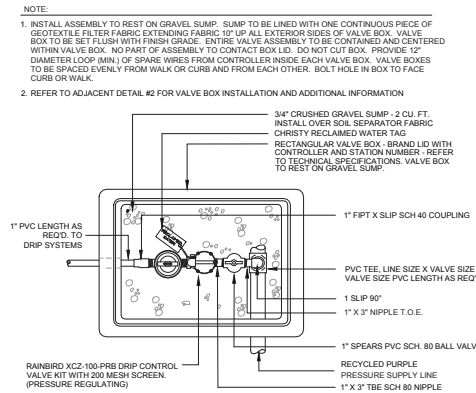

3 DRIP VALVE
NTS

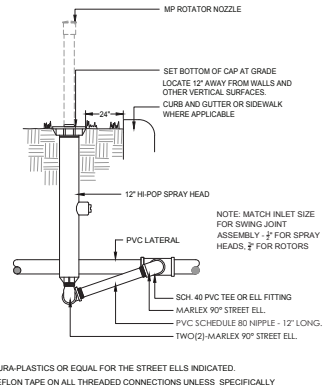

4 12" POP-UP SPRINKLER
NTS

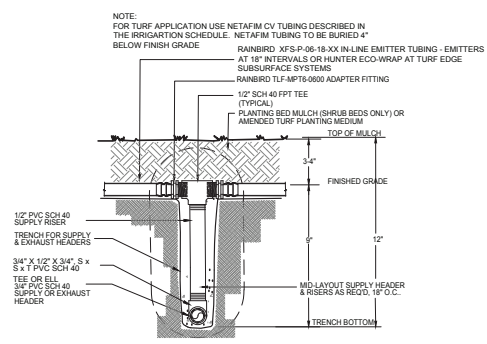

5 DRIP INTAKE HEADER MANIFOLD
NTS

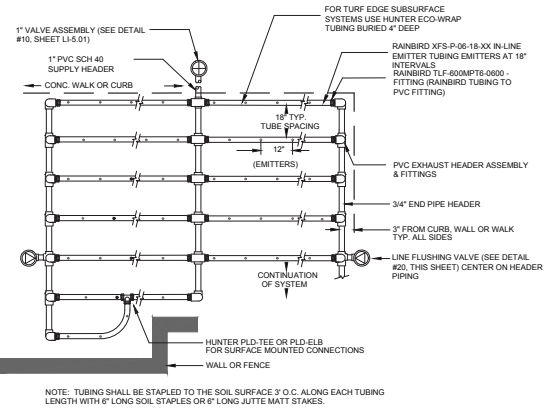

6 IN-LINE EMITTER TUBING IRRIGATION LAYOUT SHRUB DRIP CONDITION
NTS

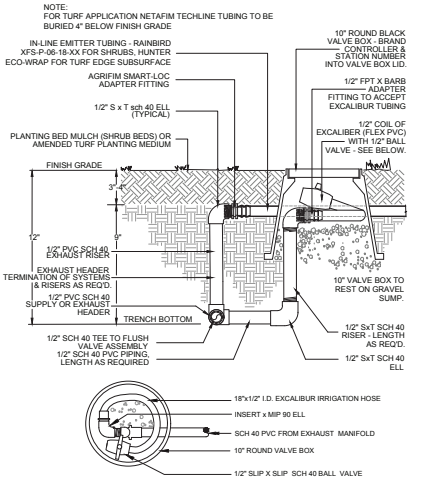

7 DRIP EXHAUST HEADER MANIFOLD - FLUSH VALVE
NTS

- NOTES:**
- Refer to Sheet LI - 1 for Irrigation Schedule.
 - Refer to Sheet LI - 2 for Irrigation Plans.
 - Refer to Sheet LI - 3 for Irrigation Details.
 - Refer to Sheet LI - 4 for Irrigation Specifications

REVISIONS				DESIGNED BY:	PLANS PREPARED BY:	DATE:	BY:	SCALES	DESIGNED BY:	PLANS PREPARED BY:	DATE:	BY:
NO.	DESCRIPTION	DATE	BY									

 SANTA CLARITA VALLEY WATER AGENCY WATER RESOURCES SECTION 2020 SANTA CLARITA, CA. 91350 (661) 259-2737	BRIDGEPORT POCKET PARK IRRIGATION DETAILS	PROJECT NO: 200701	DATE: AUGUST 2020
		SHEET: LI-3	PROJECT FIRM: a2i Aqua Commercial Irrigation 810 Los Valdesos Blvd., Suite 204 San Marcos, California 92069 Ph: (760) 750-1950 Fax: (760) 750-1999
		10 OF 11	PROJECT NO: 200701
		SHEET: LI-3	DATE: AUGUST 2020

[This page intentionally left blank.]

**Santa Clarita Valley Water Agency
Water Resources & Watershed Committee and Board Calendar**

**ITEM NO.
8**

FY 2022/23

	Item	Jul 5 Board	Jul 13 Comm	July 19 Board	Aug 2 Board	Aug 10 Comm	Aug 16 Board	Sep 6 Board	Sep 14 Comm	Oct 4 Board	Oct 12 Comm	Nov 1 Board	Nov 9 Comm	Dec 6 Board	Dec 14 Comm	Jan 3 Board	Jan 11 Comm	Feb 7 Board	Feb 8 Comm	Mar 7 Board	Mar 8 Comm	Apr 4 Board	Apr 12 Comm	May 2 Board	May 10 Comm	Jun 6 Board	Jun 7 Comm
1	Recommend Authorizing the General Manager to Enter into an Agreement with GSI Water Solutions, Inc. for the First Year of Groundwater Sustainability Plan Implementation		C		C																						
2	Status of Drought Response and Performance		C			C					P		P		P		P		P		P		P		P		P
3	Update on Conservation Activities & Performance						C				P		P		P		P		P		P		P		P		P
4	Devil's Den Semi-Annual Report						C												P								
5	Recommend Adoption of a Resolution Authorizing the General Manager to Apply for Grant Funding Under the WaterSmart Water Energy Efficiency Grant Program and Execute a Grant Agreement with the Federal Bureau of Reclamation						C	C																			
6	Status of Groundwater Recharge Feasibility Studies						C																				
7	Recommend that the Board Authorize the General Manager to Enter Into a Long Term Water Exchange Agreement with Irvine Ranch Water District										P																
8	Recommend Authorizing the General Manager to Execute a Construction Contract for Bridgeport Pocket Park											P	P														
9	Authorize the General Manager to Enter into a MOU with Antelope Valley-East Kern Water District to Fund Planning Costs for a Portion of the Proposed Phase 2 Proposed High Desert Water Bank																										
10	Authorize General Manager to Enter into Contracts for Water Resiliency Plan Initiative													P	P												
11	Recommend Adopting a Resolution Authorizing Creation of a Standby Charge for the Tesoro del Val Annexation Area																								P	P	
12	Status of Water Supply and Water Banking Programs											P	P														
13	Update on Water Resiliency Plan Initiative Activities											P															
14	Recommend Adoption of a Resolution Approving the SB 221 Water Supply Verification for the Tesoro Del Valle																										
15	Recommend Approval of a Resolution Adopting Recycled Water Rules and Regulations																										
16	Status of Recycled Water Program																										
17	Status of Urban Water Management Plan Review Updates																										

**Santa Clarita Valley Water Agency
Water Resources & Watershed Committee and Board Calendar**

**ITEM NO.
8**

FY 2022/23

	Item	Jul 5 Board	Jul 13 Comm	July 19 Board	Aug 2 Board	Aug 10 Comm	Aug 16 Board	Sep 6 Board	Sep 14 Comm	Oct 4 Board	Oct 12 Comm	Nov 1 Board	Nov 9 Comm	Dec 6 Board	Dec 14 Comm	Jan 3 Board	Jan 11 Comm	Feb 7 Board	Feb 8 Comm	Mar 7 Board	Mar 8 Comm	Apr 4 Board	Apr 12 Comm	May 2 Board	May 10 Comm	Jun 6 Board	Jun 7 Comm
18	Status of Water Supplies														P		P		P				P		P		P
19	Status of Sustainable Groundwater Management Act Implementation																				P						
20	Review and Discussion of FY 2023/24 and FY 2024/25 Water Resources Operating Budget and Minor and Major Capital Projects Budgets																						P				
21	Recommend Adoption of a Resolution Approving the SB 610 Water Supply Assessment for the Wiley Canyon Mixed-Use Development	C																									
22	Status of Upper Santa Clara River Salt and Nutrient Management Plan		C																								
23	Water Conservation Garden and Education Experience - Design Update																										
24	Update on Water Operating Plan and Water Conservation Response Actions								P	P																	
25	Recommend Adoption of a Resolution Approving the SB 610 Water Supply Assessment for the Shadowbox Studios Development.								P	P																	
26	Recommend Adoption of Sustainability Action Plan										P	P															

P = Planned
C = Completed
CNL = Cancelled
CNT = Continued Item